

Solutions to All Practice Exercises for Math 135

Contains Midterm Exams Fall 2017 to Fall 2022
(Arranged by Semester)

Contents

1	Midterm Exams (Arranged by Semester)	4
1.1	Fall 2017	5
	Midterm Exam #1	6
	Midterm Exam #2	10
1.2	Spring 2018	15
	Midterm Exam #1	16
	Midterm Exam #2	21
1.3	Fall 2018	26
	Midterm Exam #1	27
	Midterm Exam #2	32
1.4	Spring 2019	38
	Midterm Exam #1	39
	Midterm Exam #2	43
1.5	Fall 2019	49
	Midterm Exam #1	50
	Midterm Exam #2	54
1.6	Spring 2020	60
	Midterm Exam #1	61
	Midterm Exam #2A	65
	Midterm Exam #2B	71
	Midterm Exam #3	78
1.7	Summer 2020	85
	Midterm Exam #1	86
	Midterm Exam #2	90
	Midterm Exam #3	94
	Midterm Exam #4	96
	Midterm Exam #5	99
	Midterm Exam #6	102
	Midterm Exam #7	106
1.8	Fall 2020	109
	Midterm Exam #1A	110
	Midterm Exam #1B	113
	Midterm Exam #2	117
	Midterm Exam #3	121
	Midterm Exam #4	123

	Midterm Exam #5	125
	Midterm Exam #6	127
1.9	Spring 2021	132
	Midterm Exam #1	133
	Midterm Exam #2	137
	Midterm Exam #3	141
	Midterm Exam #4	144
1.10	Fall 2021	149
	Precalculus Exam	150
	Midterm Exam #1	154
	Midterm Exam #2	158
	Midterm Exam #3	162
1.11	Spring 2022	166
	Precalculus Exam	167
	Midterm Exam #1	171
	Midterm Exam #2	175
	Midterm Exam #3	179
1.12	Summer 2022	183
	Precalculus Exam	184
	Midterm Exam #1	188
	Midterm Exam #2	192
	Midterm Exam #3	196
1.13	Fall 2022	202
	Midterm Exam #1	203
	Midterm Exam #2	207
2	Practice Worksheets	211
2.1	Chapter 1: Review of Algebra and Precalculus	212
	§1.1, 1.2, 1.3, 1.4, 7.2, Appendix B	213
2.2	Chapter 2: Limits	224
	§2.1, 2.2: Introduction to Limits	225
	§2.3: Techniques for Computing Limits	227
	§2.4: Infinite Limits	233
	§2.5: Limits at Infinity	236
	§2.6: Continuity	239
2.3	Chapter 3: Derivatives	243
	§3.1, 3.2: Introduction to the Derivative	244
	§3.3, 3.4, 3.5, 3.9: Rules for Computing Derivatives	250
	§3.7: The Chain Rule	255
	§3.8: Implicit Differentiation	259
	§3.11: Related Rates	264
2.4	Chapter 4: Applications of the Derivative	270
	§4.1: Maxima and Minima	271
	§4.3, 4.4: What Derivatives Tell Us and Graphing Functions	277
	§4.5: Optimization Problems	298
	§4.6: Linear Approximation and Differentials	306
	§4.7: L'Hôpital's Rule	310
	§4.9: Antiderivatives	314
2.5	Chapter 5: Integration	317
	§5.1, 5.2: Introduction to the Integral	318
	§5.3: Fundamental Theorem of Calculus	320

	§5.5: Substitution Rule	325
2.6	Unit Review	330
	Unit #2 Review: Limits and Continuity (2.1 – 2.6, 3.5)	331
	Unit #3 Review: Derivatives and Tangent Lines (3.1 – 3.9)	335
	Unit #4 Review: Applications of the Derivative (3.11, 4.1, 4.3 – 4.7, 4.9)	341
	Unit #5 Review: Integration (5.1 – 5.3, 5.5)	358
3	Quizzes	361
3.1	Spring 2018	362
3.2	Spring 2020	376
3.3	Summer 2022	382
3.4	Fall 2022	393
4	Final Exams	403
4.1	Spring 2020	404
4.2	Fall 2021	414

1 Midterm Exams (Arranged by Semester)

1.1 Fall 2017

Midterm Exam #1

10 p

1. Find an equation of the line tangent to the graph of $f(x) = 2x^2 - 3x + 1$ at $x = 1$.

Solution

The tangent line passes through the point $(1, f(1)) = (1, 0)$. The derivative is $f'(x) = 4x - 3$, and so the slope of the tangent line is $f'(1) = 1$. Hence the equation of the tangent line is $y = 0 + 1 \cdot (x - 1)$, or $y = x - 1$.

10 p

2. Show that the equation below has at least one solution in the interval $[0, 1]$. Explain your answer.

$$x^{2/3} = 2x^2 + 2x - 2$$

Solution

Let $f(x) = 2x^2 + 2x - 2 - x^{2/3}$. Since f is a sum of power functions, f is continuous on its domain, which includes the interval $[0, 1]$. Observe that $f(0) = -2$ and $f(1) = 1$. Since 0 is between -2 and 1, the intermediate value theorem guarantees the existence of a number c in the interval $[0, 1]$ such that $f(c) = 0$. The same number c satisfies the desired equation.

10 p

3. Find all solutions to the following equation.

$$2 \ln(x) = \ln\left(\frac{x^5}{5-x}\right) - \ln\left(\frac{x^3}{2+x}\right)$$

Solution

The term on the left is equivalent to $2 \ln(x) = \ln(x^2)$ for $x > 0$. Then we move all terms to the left and combine using logarithm rules.

$$\ln(x^2) - \ln\left(\frac{x^5}{5-x}\right) + \ln\left(\frac{x^3}{2+x}\right) = 0$$

$$\ln\left(x^2 \cdot \frac{5-x}{x^5} \cdot \frac{x^3}{2+x}\right) = 0$$

$$\ln\left(\frac{5-x}{2+x}\right) = 0$$

Exponentiating each side gives $\frac{5-x}{2+x} = 1$, whence $5-x = 2+x$, and so $x = \frac{3}{2}$.

10 p

4. Find the values of the constants a and b so that the following function is continuous for all x . If this is not possible, explain why.

$$f(x) = \begin{cases} ax + b & x < 1 \\ -2 & x = 1 \\ 3\sqrt{x} + b & x > 1 \end{cases}$$

In your work, you must use limit-based methods to solve this problem. Solutions that have work that is not based on limits will not receive full credit.

Solution

The first two “pieces” of $f(x)$ are continuous for all x regardless of the values of a and b since polynomials are continuous for all x . The “piece” $3\sqrt{x} + b$ is continuous regardless of the value of b as long as $x \geq 0$. Hence each piece is continuous on each of its “pieces” separately on the respective intervals. We need only force continuity at $x = 1$ to guarantee f is continuous for all x . Hence we must choose a and b such that

$$\begin{aligned}\lim_{x \rightarrow 1^-} f(x) &= \lim_{x \rightarrow 1^+} f(x) = f(1) \\ \lim_{x \rightarrow 1^-} (ax + b) &= \lim_{x \rightarrow 1^+} (3\sqrt{x} + b) = -2 \\ a + b &= 3 + b = -2\end{aligned}$$

Hence $a = 3$ and $b = -5$.

10 p

5. Suppose $f(x)$ satisfies all of the following properties. Sketch a possible graph of $y = f(x)$ on the axes provided. *Label all asymptotes, local extrema, and inflection points. Your graph need not be to scale, but it must have the correct shape.*

Information from $f(x)$:

- the points $(1, 2)$, $(3, 3)$, and $(5, 2)$ lie on the graph of $y = f(x)$
- $\lim_{x \rightarrow +\infty} f(x) = \lim_{x \rightarrow -\infty} f(x) = 1$
- $\lim_{x \rightarrow -2^+} f(x) = \lim_{x \rightarrow 2^-} f(x) = +\infty$
- $\lim_{x \rightarrow -2^-} f(x) = \lim_{x \rightarrow 2^+} f(x) = -\infty$

Information from $f'(x)$:

- $f'(1) = f'(3) = 0$
- $f'(x) < 0$ on the intervals $(-\infty, -2)$, $(-2, 1)$, and $(3, \infty)$
- $f'(x) > 0$ on the intervals $(1, 2)$ and $(2, 3)$

Information from $f''(x)$:

- $f''(5) = 0$
- $f''(x) < 0$ on the intervals $(-\infty, -2)$ and $(2, 5)$
- $f''(x) > 0$ on the interval $(-2, 1)$, $(1, 2)$, and $(5, \infty)$

18 p

6. For each part, calculate $f'(x)$. *After calculating the derivative, do not simplify your answer.*

(a) $f(x) = \frac{7x^3}{3x^{1/2}x^5}$

(b) $f(x) = -\cos(x) \ln(x)$

(c) $f(x) = \frac{\csc(x) + 4x^3}{e^x - e^5}$

Solution

(a) Observe that $f(x) = \frac{7}{3}x^{-5/2}$. Hence $f'(x) = \frac{7}{3}(-\frac{5}{2})x^{-7/2}$.

(b) Use product rule.

$$f'(x) = -\left(\cos(x) \cdot \frac{1}{x} + (-\sin(x)) \cdot \ln(x)\right)$$

(c) Use quotient rule.

$$f'(x) = \frac{(-\csc(x)\cot(x) + 12x^2)(e^x - e^5) - (\csc(x) + 4x^3)(e^x)}{(e^x - e^5)^2}$$

7. The parts of this question are independent of each other.

2 p

(a) Given the function $g(x)$, state the definition of $g'(x)$.

(b) Let $f(x) = \sqrt{6x+1}$. Calculate $f'(1)$ directly from the definition. Show all work.

If you simply quote a rule, you will receive no credit. You must use the definition of derivative.

12 p

Solution

(a) $g'(x) = \lim_{h \rightarrow 0} \frac{g(x+h) - g(x)}{h}$

(b) Start with the definition of derivative, then simplify and cancel.

$$\begin{aligned} f'(1) &= \lim_{h \rightarrow 0} \frac{f(1+h) - f(1)}{h} = \lim_{h \rightarrow 0} \frac{\sqrt{6(1+h)+1} - \sqrt{7}}{h} = \lim_{h \rightarrow 0} \frac{\sqrt{6h+7} - \sqrt{7}}{h} \\ &= \lim_{h \rightarrow 0} \left(\frac{\sqrt{6h+7} - \sqrt{7}}{h} \cdot \frac{\sqrt{6h+7} + \sqrt{7}}{\sqrt{6h+7} + \sqrt{7}} \right) \\ &= \lim_{h \rightarrow 0} \frac{(6h+7) - 7}{h(\sqrt{6h+7} + \sqrt{7})} = \lim_{h \rightarrow 0} \frac{6h}{h(\sqrt{6h+7} + \sqrt{7})} \\ &= \lim_{h \rightarrow 0} \frac{6}{\sqrt{6h+7} + \sqrt{7}} = \frac{6}{\sqrt{7} + \sqrt{7}} = \frac{3}{\sqrt{7}} \end{aligned}$$

18 p

8. For each part, calculate the limit or show that it does not exist. *If the limit is “ $+\infty$ ” or “ $-\infty$ ”, write that as your answer, instead of “does not exist”.*

(a) $\lim_{x \rightarrow 7} \left(\frac{\frac{1}{7} - \frac{1}{x}}{x - 7} \right)$

(b) $\lim_{x \rightarrow 0} \left(\frac{\sin(7x)}{\tan(2x)} \right)$

(c) $\lim_{x \rightarrow -1} \left(\frac{|x+1|}{x+1} \right)$

Solution

(a) We have the following work.

$$\lim_{x \rightarrow 7} \left(\frac{\frac{1}{7} - \frac{1}{x}}{x - 7} \right) = \lim_{x \rightarrow 7} \left(\frac{\frac{1}{7} - \frac{1}{x}}{x - 7} \cdot \frac{7x}{7x} \right) = \lim_{x \rightarrow 7} \left(\frac{x - 7}{7x(x - 7)} \right) = \lim_{x \rightarrow 7} \left(\frac{1}{7x} \right) = \frac{1}{49}$$

(b) We have the following work.

$$\lim_{x \rightarrow 0} \left(\frac{\sin(7x)}{\tan(2x)} \right) = \lim_{x \rightarrow 0} \left(\frac{\sin(7x)}{7x} \cdot \frac{2x}{\sin(2x)} \cdot \cos(2x) \cdot \frac{7}{2} \right) = 1 \cdot 1 \cdot 1 \cdot \frac{7}{2} = \frac{7}{2}$$

(c) We first examine the corresponding one-sided limits.

$$\begin{aligned} \lim_{x \rightarrow -1^-} \left(\frac{|x+1|}{x+1} \right) &= \lim_{x \rightarrow -1^-} \left(\frac{-(x+1)}{x+1} \right) = -1 \\ \lim_{x \rightarrow -1^+} \left(\frac{|x+1|}{x+1} \right) &= \lim_{x \rightarrow -1^+} \left(\frac{+(x+1)}{x+1} \right) = +1 \end{aligned}$$

The one-sided limits are not equal, thus the desired limit does not exist.

Midterm Exam #2

12 p

9. A camera is located 5 feet from a straight wire along which a bead is moving at 6 feet per second. The camera automatically turns so that it is pointed at the bead at all times. How fast is the camera turning 2 seconds after the bead passes closest to the camera?

You must give correct units as part of your answer.

Solution

Suppose the bead travels along the x -axis. Let $O = (0, 0)$ be the origin and let $C = (0, 5)$ be the coordinates of the camera. Let $P = (x, 0)$ be the coordinates of the bead and let $\theta = \angle OCP$. Then $x = 5 \tan(\theta)$, whence $\frac{dx}{dt} = 5 \sec(\theta)^2 \frac{d\theta}{dt}$. The bead moves to the right at a rate of 6 ft/s ($\frac{dx}{dt} = 6$), and so the bead is at $Q = (12, 0)$ two seconds after it has passed closest to the camera. Hence at this time we have

$$\begin{aligned} 12 &= 5 \tan(\theta) \\ 6 &= 5 \sec(\theta)^2 \frac{d\theta}{dt} \end{aligned}$$

Note that in $\triangle OCQ$, the hypotenuse has length $\sqrt{12^2 + 5^2} = 13$ and the side adjacent to θ has length 5. Hence $\sec(\theta) = \frac{13}{5}$. Substitution into the second equation then gives us

$$6 = 5 \left(\frac{13}{5}\right)^2 \frac{d\theta}{dt} \implies \frac{d\theta}{dt} = \frac{30}{169}$$

The units are radians per second.

14 p

10. For each part, calculate the limit or show that it does not exist. If the limit is “ $+\infty$ ” or “ $-\infty$ ”, write that as your answer, instead of “does not exist”.

(a) $\lim_{x \rightarrow 0} (1 - \sin(4x))^{6/x}$

(b) $\lim_{x \rightarrow 1} \left(\frac{xe^{4x} + 4e^4 - 5e^4x}{(x-1)^2} \right)$

Solution

- (a) Substitution of $x = 0$ gives the indeterminate form 1^∞ . Let L be the desired limit and consider $\ln(L)$. Then we have

$$\ln(L) = \ln \left(\lim_{x \rightarrow 0} (1 - \sin(4x))^{6/x} \right) = \lim_{x \rightarrow 0} \ln \left((1 - \sin(4x))^{6/x} \right) = \lim_{x \rightarrow 0} \left(\frac{6 \ln(1 - \sin(4x))}{x} \right)$$

We have used continuity of the logarithm and logarithm identities. Substitution of $x = 0$ now gives the indeterminate form $\frac{0}{0}$, whence we may use L'Hospital's Rule (and for any subsequent indeterminate forms of $\frac{0}{0}$).

$$\lim_{x \rightarrow 0} \left(\frac{6 \ln(1 - \sin(4x))}{x} \right) \stackrel{H}{=} \lim_{x \rightarrow 0} \left(\frac{6 \cdot \frac{1}{1 - \sin(4x)} \cdot (-4 \cos(4x))}{1} \right) = \frac{6 \cdot \frac{1}{1-0} \cdot (-4)}{1} = -24$$

Hence $\ln(L) = -24$, and so $L = e^{-24}$.

- (b) Substitution of $x = 1$ gives the indeterminate form $\frac{0}{0}$, whence we may use L'Hospital's

Rule (and for any subsequent indeterminate forms of $\frac{0}{0}$).

$$\lim_{x \rightarrow 1} \left(\frac{xe^{4x} + 4e^4 - 5e^4x}{(x-1)^2} \right) \stackrel{H}{=} \lim_{x \rightarrow 1} \left(\frac{4xe^{4x} + e^{4x} - 5e^4}{2(x-1)} \right) \stackrel{H}{=} \lim_{x \rightarrow 0} \left(\frac{16xe^{4x} + 8e^{4x}}{2} \right) = 12e^4$$

11. Consider the function $f(x)$.

$$f(x) = \frac{4 - 3e^{-2x}}{6 - 5e^{-2x}}$$

6 p

(a) Find all horizontal asymptotes of $f(x)$.

6 p

(b) Find all vertical asymptotes of $f(x)$. Then, at each vertical asymptote, calculate both one-sided limits of $f(x)$.

Solution

(a) We compute the limits of f at infinity, using L'Hospital's Rule on the limit at $-\infty$.

$$\begin{aligned} \lim_{x \rightarrow \infty} \frac{4 - 3e^{-2x}}{6 - 5e^{-2x}} &= \frac{4 - 0}{6 - 0} = \frac{2}{3} \\ \lim_{x \rightarrow -\infty} \frac{4 - 3e^{-2x}}{6 - 5e^{-2x}} &\stackrel{H}{=} \lim_{x \rightarrow -\infty} \frac{6e^{-2x}}{10e^{-2x}} = \frac{6}{10} = \frac{3}{5} \end{aligned}$$

Hence the horizontal asymptotes are $y = \frac{2}{3}$ and $y = \frac{3}{5}$.

(b) The function f is continuous on its domain. The only x -value not in the domain of f is that x -value such that $6 - 5e^{-2x} = 0$, or $x = -\frac{1}{2} \ln\left(\frac{6}{5}\right)$. Hence the only candidate vertical asymptote is the line $x = -\frac{1}{2} \ln\left(\frac{6}{5}\right)$. (From now on, let $a = -\frac{1}{2} \ln\left(\frac{6}{5}\right)$.)

If $x = a$, then $4 - 3e^{-2x} = 4 - 3\left(\frac{6}{5}\right) = \frac{2}{5} > 0$. Now note that $g(x) = 6 - 5e^{-2x}$ is an increasing function because $g'(x) = 10e^{-2x} > 0$. Hence $6 - 5e^{-2x} < 0$ if $x < a$ and $6 - 5e^{-2x} > 0$ if $x > a$. Now we have

$$\begin{aligned} \lim_{x \rightarrow a^-} \frac{4 - 3e^{-2x}}{6 - 5e^{-2x}} &= \frac{2/5}{0^-} = -\infty \\ \lim_{x \rightarrow a^+} \frac{4 - 3e^{-2x}}{6 - 5e^{-2x}} &= \frac{2/5}{0^+} = +\infty \end{aligned}$$

12 p

12. Find all points on the graph of the equation

$$2x^2 - 4xy + 7y^2 = 45$$

at which the tangent line is horizontal. **Hint:** Find a second equation that such points must satisfy. Then solve a system of two equations in the two unknowns x and y .

Solution

The tangent line is horizontal at points where $\frac{dy}{dx} = 0$. Using implicit differentiation we have

$$4x - 4x \frac{dy}{dx} - 4y + 14y \frac{dy}{dx} = 0$$

Setting $\frac{dy}{dx} = 0$ gives the equation $4x - 4y = 0$, or $x = y$. Hence the desired points must satisfy both $x = y$ and the original equation. Substituting $x = y$ into the original equation gives

$$2x^2 - 4x^2 + 7x^2 = 45$$

Hence $5x^2 = 45$, or $x = \pm 3$. The points on the graph where the tangent line is horizontal are $(-3, -3)$ and $(3, 3)$.

13. The parts of this question are independent of each other.

3 p

(a) Complete the statement of the mean value theorem (MVT).

Suppose $f(x)$ is _____ for all x in $[a, b]$ and _____ for all x in _____. Then there exists a number c in the interval _____ such that the following equation is satisfied (*write the equation in the space below*):

6 p

(b) For each of the following parts, determine whether the MVT applies. If MVT does not apply, explain why. If MVT does apply, find all values of c guaranteed to exist by the MVT.

(i) $f(x) = (x^2 - 2x)^{1/3}$ on $[-2, 4]$

(ii) $f(x) = \frac{x+4}{x-4}$ on $[-3, 3]$

Solution

(a) Suppose $f(x)$ is continuous for all x in $[a, b]$ and differentiable for all x in (a, b) . Then there exists a number c in the interval (a, b) such that the following equation is satisfied:

$$\frac{f(b) - f(a)}{b - a} = f'(c)$$

(b) (i) The function $g(x) = x^{1/3}$ is not differentiable at $x = 0$, hence $f(x)$ is not differentiable whenever $x^2 - 2x = 0$, or at $x = 0$ and $x = 2$. These values of x are in the interval $[-2, 4]$, hence the MVT does not apply.

(ii) The equation guaranteed to have a solution by the MVT is given by

$$f'(c) = \frac{f(3) - f(-3)}{3 - (-3)}$$

This is equivalent to the equation

$$-\frac{8}{(c-4)^2} = -\frac{8}{7}$$

Hence $(c-4)^2 = 7$, or $c = 4 \pm \sqrt{7}$. However, the value $4 + \sqrt{7}$ is not in the given interval. So the only value of c described by the MVT is $c = 4 - \sqrt{7}$.

8 p

14. Use a linear approximation to estimate $\sqrt{33}$.

Solution

Let $f(x) = \sqrt{x}$ and consider the tangent line to f at $x = 36$. Observe that $f(36) = 6$ and $f'(x) = \frac{1}{2}x^{-1/2}$. Hence $f'(36) = \frac{1}{12}$ and the tangent line is:

$$y = 6 + \frac{1}{12}(x - 36)$$

Our desired approximation is then

$$\sqrt{33} \approx 6 + \frac{1}{12}(33 - 36) = 5.75$$

16 p

15. A wire of length 51 cm is cut into two pieces. One piece is bent into a square. The other piece is bent into a rectangle whose length is two times its width. How should the wire be cut and the pieces assembled so that the total area enclosed by both pieces is a minimum?

You must use calculus-based methods in your work. You must also justify that your answer really does give the minimum.

Solution

Let x be the side length of the square and let y be the width of the rectangle (so that the length of the rectangle is $2y$). The total area of the square and rectangle is

$$A(x, y) = x^2 + 2y^2$$

Now note that the perimeter of the square is $4x$ and the perimeter of the rectangle is $6y$. The total perimeter must equal the length of the wire, hence $4x + 6y = 51$. Solving for y gives $y = \frac{51-4x}{6}$, and putting this into our area formula gives our objective function in terms of x only.

$$f(x) = x^2 + 2\left(\frac{51-4x}{6}\right)^2 = x^2 + \frac{1}{18}(51-4x)^2$$

Our goal is to find the minimum value of $f(x)$ on the interval $[0, \frac{51}{4}]$. Computing the derivative gives:

$$f'(x) = 2x - \frac{4}{9}(51-4x) = \frac{34}{9}(x-6)$$

Since $f(x)$ is differentiable on the interval, the minimum must occur at a critical point or an interval endpoint. Solving $f'(x) = 0$ gives $x = 6$, implying that the wire should be cut into a piece 24 cm long (which is bent into a square) and a piece 27 cm long (which is bent into the described rectangle).

Now observe that the second derivative of our area function is $f''(x) = \frac{34}{9}$, which is strictly positive for all x . Hence the graph of $f(x)$ is concave up on the entire interval $[0, \frac{51}{4}]$. This means that the only critical point we found must give a global minimum of $f(x)$.

16. Consider the function $f(x) = (x-5)(x+10)^2 = x^3 + 15x^2 - 500$.

1 p

(a) Calculate all x - and y -intercepts of f .

6 p

(b) Find where f is increasing and find where f is decreasing. Then calculate the x - and y -coordinates of all local extrema, classifying each as either a local minimum or a local maximum.

6 p

(c) Find where f is concave up and find where f is concave down. Then calculate the x - and y -coordinates of all inflection points.

4 p

(d) Sketch the graph of $y = f(x)$ on the provided grid. *Label all asymptotes, local extrema, and inflection points. Your graph need not to be to scale, but it must have the correct shape.*

Solution

- (a) The equation $f(x) = 0$ has solutions $x = 5$ and $x = -10$, whence the x -intercepts are $(5, 0)$ and $(-10, 0)$. The y -intercept is $(0, -500)$.

(b) We calculate a sign chart for the first derivative:

$$f'(x) = 3x^2 + 30x = 3x(x + 10)$$

The cut points are the solutions to $f'(x) = 0$: $x = 0$ and $x = -10$.

interval	test point	sign	shape of f
$(-\infty, -10)$	$f'(-21)$	$\ominus\ominus = \oplus$	increasing
$(-10, 0)$	$f'(-5)$	$\ominus\oplus = \ominus$	decreasing
$(0, \infty)$	$f'(1)$	$\oplus\oplus = \oplus$	increasing

Hence we deduce the following about f :

$$\begin{aligned} f \text{ is decreasing on:} & \quad [-10, 0] \\ f \text{ is increasing on:} & \quad (-\infty, -10], [0, \infty) \\ f \text{ has a local min at:} & \quad x = 0 \\ f \text{ has a local max at:} & \quad x = -10 \end{aligned}$$

(c) We calculate a sign chart for the second derivative:

$$f''(x) = 6x + 30 = 6(x + 5)$$

The cut points are the solutions to $f''(x) = 0$: $x = -5$ only.

interval	test point	sign	shape of f
$(-\infty, -5)$	$f''(-6)$	\ominus	concave down
$(-5, \infty)$	$f''(0)$	\oplus	concave up

Hence we deduce the following about f :

$$\begin{aligned} f \text{ is concave down on:} & \quad (-\infty, -5] \\ f \text{ is concave up on:} & \quad [-5, \infty) \\ f \text{ has an infl. point at:} & \quad x = -5 \end{aligned}$$

(d) Using the previous solutions, we have the following sketch.

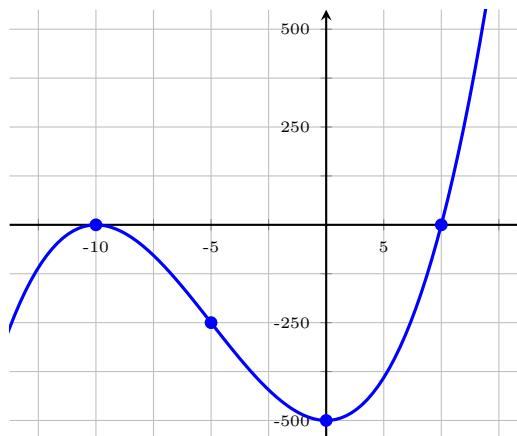

1.2 Spring 2018

Midterm Exam #1

17. The parts of this question are independent of each other.

2 p

(a) Given the function $g(x)$, state the definition of $g'(4)$.

12 p

(b) Let $F(x) = \frac{1}{3x-5}$. Calculate $F'(2)$ directly from the definition. Show all work.

If you simply quote a rule, you will receive no credit. You must use the definition of derivative.

Solution

$$(a) \quad g'(4) = \lim_{h \rightarrow 0} \left(\frac{g(4+h) - g(4)}{h} \right)$$

(b) Start with the definition of derivative, then simplify and cancel.

$$\begin{aligned} F'(2) &= \lim_{h \rightarrow 0} \left(\frac{F(2+h) - F(2)}{h} \right) = \lim_{h \rightarrow 0} \left(\frac{\frac{1}{3(2+h)-5} - 1}{h} \right) = \lim_{h \rightarrow 0} \left(\frac{\frac{1}{3h+1} - 1}{h} \right) \\ &= \lim_{h \rightarrow 0} \left(\frac{1 - (3h+1)}{h(3h+1)} \right) = \lim_{h \rightarrow 0} \left(\frac{-3}{3h+1} \right) = \frac{-3}{0+1} = -3 \end{aligned}$$

15 p

18. For each part, calculate $f'(x)$. After calculating the derivative, do not simplify your answer.

$$(a) \quad f(x) = \frac{x^{-1}x^{8/3}}{4\sqrt[3]{x^2}}$$

$$(b) \quad f(x) = (x + \sqrt{5x-6})^{1/4}$$

$$(c) \quad f(x) = \frac{x^2 e^x}{\ln(x) - \cos(x)}$$

Solution

(a) Simplifying the exponents, we observe that $f(x) = \frac{1}{4}x$. Hence $f'(x) = \frac{1}{4}$.

(b) Use power rule and chain rule (twice!).

$$f'(x) = \frac{1}{4} (x + \sqrt{5x-6})^{-3/4} \cdot \left(1 + \frac{1}{2} (5x-6)^{-1/2} \cdot 5 \right)$$

(c) Use quotient rule. When differentiating the numerator, use product rule.

$$f'(x) = \frac{(x^2 e^x + 2x e^x) \cdot (\ln(x) - \cos(x)) - (x^2 e^x) \cdot \left(\frac{1}{x} + \sin(x)\right)}{(\ln(x) - \cos(x))^2}$$

15 p

19. For each part, calculate the limit or show that it does not exist. If the limit is “ $+\infty$ ” or “ $-\infty$ ”, write that as your answer, instead of “does not exist”.

$$(a) \quad \lim_{x \rightarrow 0} \left(\frac{(2x+9)^2 - 81}{x} \right)$$

$$(b) \quad \lim_{x \rightarrow 3^-} \left(\frac{|x-3|}{x-3} \right)$$

$$(c) \quad \lim_{x \rightarrow 1} \left(\frac{5 - \sqrt{32-7x}}{x-1} \right)$$

Solution

(a) Expand the numerator and cancel common factors.

$$\lim_{x \rightarrow 0} \left(\frac{(2x+9)^2 - 81}{x} \right) = \lim_{x \rightarrow 0} \left(\frac{4x^2 + 36x}{x} \right) = \lim_{x \rightarrow 0} (4x + 36) = 36$$

(b) If $x \rightarrow 3^-$, then we may assume that $x < 3$, or $x - 3 < 0$. For such values of x , we have

that $|x - 3| = -(x - 3)$. So now we have

$$\lim_{x \rightarrow 3^-} \left(\frac{|x - 3|}{x - 3} \right) = \lim_{x \rightarrow 3^-} \left(\frac{-(x - 3)}{x - 3} \right) = -1$$

(c) Rationalize the numerator and cancel common factors.

$$\begin{aligned} \lim_{x \rightarrow 1} \left(\frac{5 - \sqrt{32 - 7x}}{x - 1} \right) &= \lim_{x \rightarrow 1} \left(\frac{5 - \sqrt{32 - 7x}}{x - 1} \cdot \frac{5 + \sqrt{32 - 7x}}{5 + \sqrt{32 - 7x}} \right) \\ &= \lim_{x \rightarrow 1} \left(\frac{25 - (32 - 7x)}{(x - 1)(5 + \sqrt{32 - 7x})} \right) \\ &= \lim_{x \rightarrow 1} \left(\frac{7(x - 1)}{(x - 1)(5 + \sqrt{32 - 7x})} \right) \\ &= \lim_{x \rightarrow 1} \left(\frac{7}{5 + \sqrt{32 - 7x}} \right) = \frac{7}{10} \end{aligned}$$

10 p

20. The graph of a function $f(x)$ is shown below.

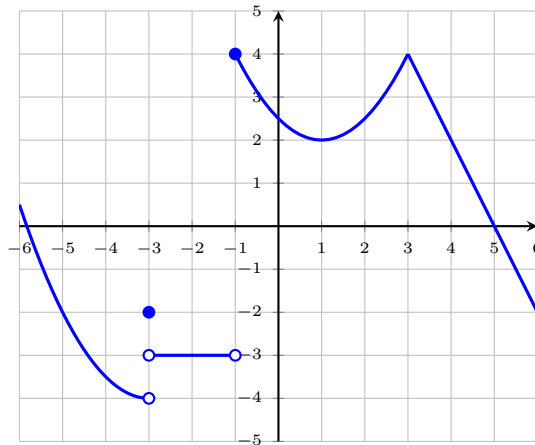

- State where $f(x)$ is *not* continuous in the interval $(-5, 5)$.
- State where $f(x)$ is *not* differentiable in the interval $(-5, 5)$.
- State where $f'(x) = 0$ in the interval $(-5, 5)$.
- State where $f'(x) < 0$ in the interval $(-5, 5)$.

Solution

- $x = -3, x = -1$
- $x = -3, x = -1, x = 3$

Recall that continuity is necessary for differentiability. So any points of discontinuity are also points of non-differentiability. At $x = 3$, the graph exhibits a sharp corner, which means the function is not differentiable there.

- all x -values in the interval $(-3, -1)$ or $x = 1$.

Recall that if $f'(a) = 0$, then the graph of $y = f(x)$ has a horizontal tangent line at $x = a$. That is, the slope of the graph of $f(x)$ is 0.

(d) on each of the intervals $(-5, -3)$, $(-1, 1)$, and $(3, 5)$

21. Each part of this question refers to the function $f(x)$ below, where a and b are unspecified constants.

$$f(x) = \begin{cases} \frac{\sin(ax)}{x} & x < 0 \\ 2x + 3 & 0 \leq x < 1 \\ b & x = 1 \\ \frac{x^2 - 1}{x - 1} & 1 < x \end{cases}$$

In your work, you must use limit-based methods to solve this problem. Solutions that have work that is not based on limits will not receive full credit.

7 p

(a) Find the value of a so that f is continuous at $x = 0$. If this is not possible, explain why.

7 p

(b) Find the value of b so that f is continuous at $x = 1$. If this is not possible, explain why.

Solution

(a) We require that the left-limit, right-limit, and function value all be equal at $x = 0$. We have the following.

$$\begin{aligned} \lim_{x \rightarrow 0^-} f(x) &= \lim_{x \rightarrow 0^-} \left(\frac{\sin(ax)}{x} \right) = \lim_{x \rightarrow 0^-} \left(a \cdot \frac{\sin(ax)}{ax} \right) = a \cdot 1 = a \\ \lim_{x \rightarrow 0^+} f(x) &= \lim_{x \rightarrow 0^+} (2x + 3) = 3 \\ f(0) &= (2x + 3)|_{x=0} = 3 \end{aligned}$$

So we must have that $a = 3$.

(b) We require that the left-limit, right-limit, and function value all be equal at $x = 1$. We have the following.

$$\begin{aligned} \lim_{x \rightarrow 1^-} f(x) &= \lim_{x \rightarrow 1^-} (2x + 3) = 5 \\ \lim_{x \rightarrow 1^+} f(x) &= \lim_{x \rightarrow 1^+} \left(\frac{x^2 - 1}{x - 1} \right) = \lim_{x \rightarrow 1^+} \left(\frac{(x - 1)(x + 1)}{x - 1} \right) = \lim_{x \rightarrow 1^+} (x + 1) = 2 \\ f(1) &= b \end{aligned}$$

So we must have that $5 = 2 = b$, which is impossible.

(It is impossible to find such a value of b because $\lim_{x \rightarrow 1} f(x)$ does not exist.)

10 p

22. Find an equation of each line that is both tangent to the graph of $f(x) = 4x^2 - 3x - 1$ and parallel to the line $y = 13x - 5$.

Solution

The slope of the line $y = 13x - 5$ is 13, hence the slope of the desired tangent line is also 13 since parallel lines have equal slope. Hence we must solve the equation $f'(x) = 13$.

$$f'(x) = 8x - 3 = 13 \implies x = 2$$

Observe that $f(2) = 9$. Hence the desired tangent line is $y = 9 + 13(x - 2)$.

6 p

23. Suppose $f(x)$ is continuous on the interval $[0, 6]$. Selected values of f are given in the table below.

x	0	1	2	3	4	5	6
$f(x)$	-3	2	12	-5	-1	4	4

On what intervals is the graph of $y = f(x)$ guaranteed to intersect the x -axis? Explain your answer.

List as many intervals as possible, but no two intervals can overlap.

Solution

Since f is continuous on $[0, 6]$, the intermediate value theorem (IVT) applies to this interval and any subintervals. Hence the IVT guarantees that $f(x) = 0$ on any interval on which the values of f change sign (either from positive to negative or negative to positive). There are three such intervals: $(0, 1)$, $(2, 3)$, and $(4, 5)$.

24. A coffee vendor has collected data on the price of coffee in her store over the last year. The price of coffee (in dollars per pound) t weeks since when the data collection began was

$$p(t) = 0.02t^2 - 0.1t + 6$$

The vendor also found that, in a given week, the local consumers bought approximately

$$D(p) = \frac{2500}{p^2 + 1}$$

pounds of coffee when the price was p dollars per pound. That is, D is the weekly demand of the consumers. For each part, you must give correct units as part of your answer.

3 p

(a) How much did the price of one pound of coffee increase in the first ten weeks after the data collection began?

3 p

(b) What was the average rate at which the price of one pound of coffee changed over the same ten-week period mentioned in part (a)?

5 p

(c) Calculate $D'(7)$ and explain its precise meaning in the given context.

5 p

(d) At what rate was the weekly demand for coffee changing with respect to time exactly ten weeks after data collection began?

Solution

(a) The change in price is $\Delta p = p(10) - p(1) = 7 - 6 = 1$. The units are *dollars*.

(b) The average rate is $\frac{\Delta p}{\Delta t} = \frac{p(10) - p(1)}{10 - 1} = \frac{1}{9}$. The units are *dollars per week*.

(c) First find the derivative of D using chain rule or quotient rule.

$$D'(p) = -\frac{5000p}{(p^2 + 1)^2}$$

Now substitute $p = 7$.

$$D'(7) = -\frac{5000 \cdot 7}{50^2} = -\frac{5000 \cdot 7}{2500} = -14$$

The units are *pounds per dollar*. When the price of one pound of coffee was 7 dollars, the weekly demand was decreasing at a rate of 14 pounds per dollar. In other words, if this rate

were constant, this would mean that each additional 1-dollar increase in the price would result in a loss of 14 pounds in the weekly demand.

(d) Observe that $D = D(p(t))$. So we must use chain rule.

$$\frac{dD}{dt} = \frac{d}{dt}D(p(t)) = D'(p(t)) \cdot p'(t)$$

Now substitute $t = 10$.

$$\left. \frac{dD}{dt} \right|_{t=10} = D'(p(10)) \cdot p'(10)$$

Now we compute each of these numbers. The following have already been computed in previous parts.

$$\begin{aligned} p(10) &= 7 \\ D'(p(10)) &= D'(7) = -14 \end{aligned}$$

The following have not already been computed.

$$\begin{aligned} p'(t) &= 0.04t - 0.1 \\ p'(10) &= 0.04 \cdot 10 - 0.1 = 0.3 \end{aligned}$$

Hence we find that

$$\left. \frac{dD}{dt} \right|_{t=10} = D'(p(10)) \cdot p'(10) = (-14) \cdot (0.3) = -4.2$$

The units are *pounds per week*.

Midterm Exam #2

8 p

25. At a certain factory, the daily output is

$$Q(L) = 1500L^{2/3}$$

where L denotes the size of the labor force measured in worker-hours. Currently 1,000 worker-hours of labor are used each day. Use a linear approximation to estimate the effect on the daily output if the labor force is cut to 975 worker-hours.

Solution

We use the tangent line to $Q(L)$ at $L = 1000$. Observe that $Q'(L) = 1000L^{-1/3}$, whence $Q'(1000) = 100$. The desired tangent line is:

$$y - Q(1000) = 100(L - 1000)$$

(Note that we don't need the value of $Q(1000)$.) The required estimate of $\Delta Q = Q(975) - Q(1000)$ is obtained by substituting $L = 975$ into our tangent line.

$$\Delta Q = Q(975) - Q(1000) \approx 100(975 - 1000) = -2500$$

So the output decreases by approximately 2500 units.

8 p

26. Find an equation of the line tangent to the following curve at the point $(2, 0)$.

$$x^3 + e^{xy} = 3y + 9$$

Solution

Implicitly differentiating the equation with respect to x gives

$$3x^2 + e^{xy} \left(x \frac{dy}{dx} + y \right) = 3 \frac{dy}{dx}$$

Substituting $x = 2$ and $y = 0$ gives

$$12 + 1 \cdot \left(2 \frac{dy}{dx} + 0 \right) = 3 \frac{dy}{dx} \implies \frac{dy}{dx} = 12$$

Hence the equation of the tangent line is

$$y - 0 = 12(x - 2)$$

10 p

27. Suppose $f(x)$ satisfies all of the following properties. Sketch a possible graph of $y = f(x)$ on the axes provided. *Label all asymptotes, local extrema, and inflection points. Your graph need not to be to scale, but it must have the correct shape.*

domain of f :	$[-8, 8]$
specific points on graph:	$f(-2) = -3$ and $f'(-6) = 0$
asymptotes of f :	$x = -2$ and $y = -3$
f is decreasing on:	$[-8, -2), (-2, 2)$
f is increasing on:	$(2, 8]$
f is concave down on:	$(-1, 1)$
f is concave up on:	$[-8, -1), (1, 8]$

Solution

There are many such solutions. Here is one.

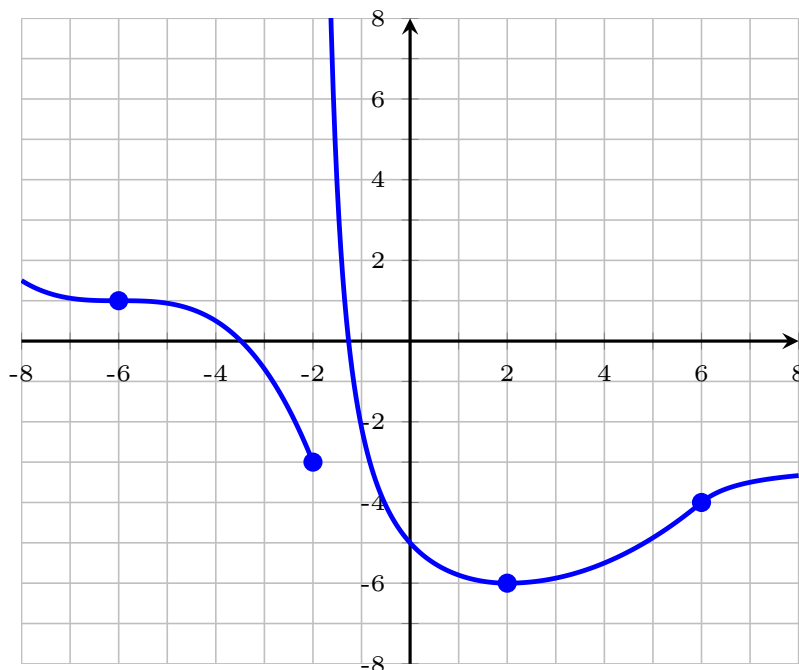
**10 p**

28. The total surface area of a cube is changing at a rate of $12 \text{ in}^2/\text{s}$ when the length of one of the sides is 10 in. At what rate is the volume of the cube changing at that time?

Solution

Let x be the side length of the cube. Then the total surface area and volume of the cube are

$$S = 6x^2 \quad V = x^3$$

Differentiating with respect to time t gives

$$\frac{dS}{dt} = 12x \frac{dx}{dt} \quad \frac{dV}{dt} = 3x^2 \frac{dx}{dt}$$

These four equations hold for all time. Now we substitute the information relevant to the specific time, i.e., $x = 10$ and $\frac{dS}{dt} = 12$.

$$S = 600 \quad V = 1000 \quad 12 = 120 \frac{dx}{dt} \quad \frac{dV}{dt} = 300 \frac{dx}{dt}$$

Solving for $\frac{dx}{dt}$ in the third equation gives $\frac{dx}{dt} = \frac{1}{10}$. Substituting into the fourth equation gives

$$\frac{dV}{dt} = 300 \cdot \frac{1}{10} = 30$$

Hence the volume of the cube is increasing at a rate of $30 \text{ in}^3/\text{sec}$.

12 p

29. Find the minimum and maximum values of $f(x) = 2x^3 - 3x^2 - 12x + 18$ on the interval $[-3, 3]$.

Hint: You may use the factorization $f(x) = (x^2 - 6)(2x - 3)$ to make any required arithmetic easier.

Solution

Since f is differentiable everywhere, the only critical points are solutions to $f'(x) = 0$.

$$0 = f'(x) = 6x^2 - 6x - 12 = 6(x - 2)(x + 1) \implies x = -1 \text{ or } x = 2$$

Now we find the values of f at the critical points and endpoints of the interval. (We may use the factored form of f to make the arithmetic easier.)

$$\begin{array}{cccccc} x & -3 & -1 & 2 & 3 \\ \hline f(x) & -27 & 25 & -2 & 9 \end{array}$$

Hence the absolute minimum is -27 and the absolute maximum is 25 .

12 p

- 30.** For each part, calculate the limit or show that it does not exist. *If the limit is “ $+\infty$ ” or “ $-\infty$ ”, write that as your answer, instead of “does not exist”.*

(a) $\lim_{x \rightarrow 1} \left(\frac{x^{1/4} - 1}{e^{2x} - e^2} \right)$

(b) $\lim_{x \rightarrow 1} \left((x - 1) \tan \left(\frac{\pi x}{2} \right) \right)$

Solution

(a) Direct substitution of $x = 1$ gives $\frac{0}{0}$, so we use L'Hospital's Rule.

$$\lim_{x \rightarrow 1} \left(\frac{x^{1/4} - 1}{e^{2x} - e^2} \right) \stackrel{H}{=} \lim_{x \rightarrow 1} \left(\frac{\frac{1}{4}x^{-3/4}}{2e^{2x}} \right) = \frac{\frac{1}{4}}{2e^2} = \frac{1}{8e^2}$$

(b) Direct substitution of $x = 1$ gives $0 \cdot \infty$. So we write the product as a quotient and then use L'Hospital's Rule.

$$= \lim_{x \rightarrow 1} \left(\frac{(x - 1) \sin \left(\frac{\pi x}{2} \right)}{\cos \left(\frac{\pi x}{2} \right)} \right) \stackrel{H}{=} \lim_{x \rightarrow 1} \left(\frac{\sin \left(\frac{\pi x}{2} \right) + (x - 1) \cos \left(\frac{\pi x}{2} \right) \cdot \frac{\pi}{2}}{-\sin \left(\frac{\pi x}{2} \right) \cdot \frac{\pi}{2}} \right) = -\frac{2}{\pi}$$

16 p

- 31.** You are constructing a rectangular box with a total surface area (six sides) of 450 in^2 . The length of the box is three times its width. Find the dimensions of the box, measured in inches, with the largest possible volume.

You must use calculus-based methods in your work. You must also justify that your answer really does give the maximum.

Solution

Let ℓ , w , and h denote the length, width, and height of the box, respectively. We want to maximize the volume $V(\ell, w, h) = \ell wh$. Since V is a function of 3 variables, we must eliminate 2 of the variables. We will solve for all variables in terms of the width w .

We immediately have that $\ell = 3w$. The total surface area is given by $S = 2\ell w + 2\ell h + 2wh$. Substituting $S = 450$ and $\ell = 3w$ gives

$$450 = 6w^2 + 8wh$$

Now we solve for h in terms of w .

$$h = \frac{225 - 3w^2}{4w}$$

Rewriting ℓ and h in terms of w in our volume function shows that V may be written as the single variable function

$$f(w) = 3w \cdot w \cdot \frac{225 - 3w^2}{4w} = \frac{3}{4} (225w - 3w^3)$$

We now maximize $f(w)$ on the interval $w \in (0, \sqrt{75}]$. (The interval is found by considering the extreme cases $\ell = 0$, $w = 0$, $h = 0$ as degenerate boxes. However, the precise interval won't be important for our solution.)

Since $f(w)$ is differentiable everywhere (it is a polynomial), the only critical numbers are solutions to $f'(w) = 0$.

$$0 = f'(w) = \frac{3}{4} (225 - 9w^2) \implies w^2 = \frac{225}{9} = 25 \implies w = 5$$

(The solution $w = -5$ is not physical since width cannot be negative.) Now observe that $f''(w) = -\frac{3}{4}(18w) < 0$ for all $w > 0$. Hence the graph of $f(w)$ is concave down for $w > 0$, and so $w = 5$ gives a maximum value of $f(w)$.

The optimal dimensions are $\ell = 15$, $w = 5$, and $h = 7.5$ (all measured in inches).

32. Consider the function f and its derivatives below.

$$f(x) = \frac{x^2}{x^2 - 1} \quad , \quad f'(x) = \frac{-2x}{(x^2 - 1)^2} \quad , \quad f''(x) = \frac{6x^2 + 2}{(x^2 - 1)^3}$$

6 p

(a) Find all horizontal asymptotes of f .

6 p

(b) Find all vertical asymptotes of f . Then at each vertical asymptote you find, calculate the corresponding one-sided limits of f .

6 p

(c) Find where f is decreasing and find where f is increasing. Then calculate all points of local extrema, classifying each as either a local minimum, a local maximum, or neither.

6 p

(d) Find where f is concave down and find where f is concave up. Then calculate all points of inflection.

Solution

(a) Horizontal asymptotes are found by computing the limits of f at infinity.

$$\lim_{x \rightarrow \pm\infty} \left(\frac{x^2}{x^2 - 1} \right) = \lim_{x \rightarrow \pm\infty} \left(\frac{1}{1 - \frac{1}{x^2}} \right) = \frac{1}{1 - 0} = 1$$

Hence the only horizontal asymptote is the line $y = 1$.

(b) Since f is continuous on its domain, the only candidate vertical asymptotes are the lines $x = -1$ and $x = 1$ (since there are the only x -values not in the domain of f). Direct substitution of either $x = -1$ or $x = 1$ into $f(x)$ gives the expression " $\frac{1}{0}$ ", which is undefined but indicates that all of the corresponding one-sided limits at both $x = -1$ and $x = 1$ are infinite. Hence $x = -1$ and $x = 1$ are vertical asymptotes. Now we may compute

the limits using sign analysis.

$$\lim_{x \rightarrow -1^-} \left(\frac{x^2}{x^2 - 1} \right) = \frac{1}{0^+} = +\infty$$

$$\lim_{x \rightarrow -1^+} \left(\frac{x^2}{x^2 - 1} \right) = \frac{1}{0^-} = -\infty$$

$$\lim_{x \rightarrow 1^-} \left(\frac{x^2}{x^2 - 1} \right) = \frac{1}{0^-} = -\infty$$

$$\lim_{x \rightarrow 1^+} \left(\frac{x^2}{x^2 - 1} \right) = \frac{1}{0^+} = +\infty$$

- (c) We calculate a sign chart for the first derivative. The cut points are the solutions to $f'(x) = 0$ ($x = 0$) and the vertical asymptotes ($x = -1$ and $x = 1$).

interval	test point	sign of f'	shape of f
$(-\infty, -1)$	$f'(-2)$	$\oplus = \oplus$	increasing
$(-1, 0)$	$f'(-0.5)$	$\oplus = \oplus$	increasing
$(0, 1)$	$f'(0.5)$	$\ominus = \ominus$	decreasing
$(1, \infty)$	$f'(2)$	$\ominus = \ominus$	decreasing

Hence we deduce the following about f :

$$\begin{aligned} f \text{ is decreasing on:} & \quad [0, 1), (1, \infty) \\ f \text{ is increasing on:} & \quad (-\infty, -1), (-1, 0] \\ f \text{ has a local min at:} & \quad \text{none} \\ f \text{ has a local max at:} & \quad x = 0 \end{aligned}$$

- (d) We calculate a sign chart for the second derivative: The cut points are the solutions to $f''(x) = 0$ (none) and the vertical asymptotes ($x = -1$ and $x = 1$).

interval	test point	sign of f''	shape of f
$(-\infty, -1)$	$f''(-2)$	$\oplus = \oplus$	concave up
$(-1, 1)$	$f''(0)$	$\ominus = \ominus$	concave down
$(1, \infty)$	$f''(2)$	$\oplus = \oplus$	concave up

Hence we deduce the following about f :

$$\begin{aligned} f \text{ is concave down on:} & \quad (-1, 1) \\ f \text{ is concave up on:} & \quad (-\infty, -1), (1, \infty) \\ f \text{ has an infl. point at:} & \quad \text{none} \end{aligned}$$

1.3 Fall 2018

Midterm Exam #1

33. A scientist measures the temperature T (measured in kelvins) of a certain metal bar t seconds after the measurements have begun. The following equation models the data observed by the scientist.

$$T(t) = \frac{30}{e^t} + 10e^t$$

The scientist also observes that the length L of the metal bar (measured in centimeters) depends on its temperature through the following equation.

$$L(T) = 0.01T^3 + \frac{64,000}{T}$$

For each part, you must give correct units as part of your answer.

6 p

- (a) Calculate $T'(\ln(3))$ and explain its meaning in the context of this problem.

3 p

- (b) Describe in plain English, as precisely and specifically as you can, what the quantity $Q = T(273) - T(152)$ represents in the context of this problem.

6 p

- (c) Calculate $L'(40)$ and explain its meaning in the context of this problem.

6 p

- (d) At what rate is the length of the bar changing with respect to time exactly $\ln(3)$ seconds after the measurements begin?

Solution

- (a) Write $T(t) = 30e^{-t} + 10e^t$. Then we have, by chain rule,

$$T'(t) = -30e^{-t} + 10e^t$$

Hence

$$T'(\ln(3)) = -30 \cdot \frac{1}{3} + 10 \cdot 3 = 20$$

The units are *kelvins per second*. After $\ln(3)$ seconds since measurements begin, the rate of change of the temperature of the bar was 20 kelvins per second. In other words, if this rate were constant, this would mean that after each additional second after $\ln(3)$ seconds, the temperature of the bar would increase by 20 kelvins.

- (b) The quantity Q is the increase in the temperature (measured in kelvins) from 152 seconds after measurements begin to 273 seconds after measurements begin.
- (c) Write $L(T) = 0.01T^3 + 64,000T^{-1}$. Then we have

$$L'(T) = 0.03T^2 - 64,000T^{-2}$$

Hence $L'(40) = 8$. The units are *centimeters per kelvin*. If the temperature of the bar is 40 kelvins, then the rate of change of the length of the bar was 8 centimeters per kelvin. In other words, if this rate were constant, this would mean that for each additional 1-kelvin increase in the temperature beyond 40 kelvins, the length of the bar would increase by 8 centimeters.

- (d) Observe that $L = L(T(t))$. So we must use chain rule.

$$\frac{dL}{dt} = \frac{d}{dt}L(T(t)) = L'(T(t)) \cdot T'(t)$$

Now substitute $t = \ln(3)$.

$$\left. \frac{dL}{dt} \right|_{t=\ln(3)} = L'(T(\ln(3))) \cdot T'(\ln(3))$$

Note that $T(\ln 3) = 40$, and so we have from our previous work

$$\left. \frac{dL}{dt} \right|_{t=\ln(3)} = L'(40) \cdot T'(\ln 3) = 8 \cdot 20 = 160$$

The units are *centimeters per second*.

20 p

34. For each part, calculate the limit or show that it does not exist. If the limit is “ $+\infty$ ” or “ $-\infty$ ”, write that as your answer, instead of “does not exist”.

(a) $\lim_{u \rightarrow 4} \left(\frac{(u+6)^2 - 25u}{u-4} \right)$

(c) $\lim_{h \rightarrow 0} \left(\frac{\sin(7+h) - \sin(7)}{h} \right)$

(b) $\lim_{s \rightarrow 1} g(s)$ where $g(s) = \begin{cases} \sqrt{1-s} & s \leq 1 \\ \frac{s^2 - s}{s-1} & s > 1 \end{cases}$

(d) $\lim_{x \rightarrow 6} \left(\frac{\frac{1}{36} - x^{-2}}{x^2 - 36} \right)$ *Hint: Use the definition of the derivative.*

Solution

(a) Expand the numerator and cancel common factors.

$$\begin{aligned} \lim_{u \rightarrow 4} \left(\frac{(u+6)^2 - 25u}{u-4} \right) &= \lim_{u \rightarrow 4} \left(\frac{u^2 + 12u + 36 - 25u}{u-4} \right) = \lim_{u \rightarrow 4} \left(\frac{u^2 - 13u + 36}{u-4} \right) \\ &= \lim_{u \rightarrow 4} \left(\frac{(u-9)(u-4)}{u-4} \right) = \lim_{u \rightarrow 4} (u-9) = -5 \end{aligned}$$

(b) We examine the one-sided limits.

$$\lim_{s \rightarrow 1^-} g(s) = \lim_{s \rightarrow 1^-} (\sqrt{1-s}) = \sqrt{1-1} = 0$$

$$\lim_{s \rightarrow 1^+} g(s) = \lim_{s \rightarrow 1^+} \left(\frac{s^2 - s}{s-1} \right) = \lim_{s \rightarrow 1^+} \left(\frac{s(s-1)}{s-1} \right) = \lim_{s \rightarrow 1^+} (s) = 1$$

Since the left-limit and right-limit are not equal, $\lim_{s \rightarrow 1} g(s)$ does not exist.

(c) Let $f(x) = \sin(x)$. Then by definition of the derivative,

$$f'(7) = \lim_{h \rightarrow 0} \left(\frac{\sin(7+h) - \sin(7)}{h} \right)$$

Since $f'(x) = \cos(x)$, the limit is $\cos(7)$.

(d) Find a common denominator and cancel common factors.

$$\lim_{x \rightarrow 6} \left(\frac{\frac{1}{36} - x^{-2}}{x^2 - 36} \cdot \frac{36x^2}{36x^2} \right) = \lim_{x \rightarrow 6} \left(\frac{x^2 - 36}{36x^2(x^2 - 36)} \right) = \lim_{x \rightarrow 6} \left(\frac{1}{36x^2} \right) = \frac{1}{1296}$$

35. The position of a particle along the x -axis at time t is given by

$$x(t) = t^3 - 6t^2 + 9t + 10$$

7 p

(a) When is the particle retreating? When is the particle advancing?

2 p

(b) What is the total distance traveled by the particle during the period $0 \leq t \leq 7$? (The table below shows selected values of the position.)

t	0	1	2	3	4	5	6	7
$x(t)$	10	14	12	10	14	30	64	122

Solution

(a) The velocity of the particle is

$$v(t) = \frac{dx}{dt} = 3t^2 - 12t + 9 = 3(t-1)(t-3)$$

We now construct a sign chart for $v(t)$, whose cut points are $t = 1$ and $t = 3$.

interval	test point	sign of $v(t)$	behavior of particle
$(-\infty, 1)$	$v(0)$	$3\ominus\ominus = \oplus$	advancing
$(1, 3)$	$v(2)$	$3\oplus\ominus = \ominus$	retreating
$(3, \infty)$	$v(4)$	$3\oplus\oplus = \oplus$	advancing

Hence the particle is retreating on $(1, 3)$ and advancing on $(-\infty, 1) \cup (3, \infty)$.

(b) On the interval $0 \leq t \leq 7$, the particle moves forward for $0 \leq t < 1$, then moves backward for $1 < t < 3$, and then moves forward for $3 < t \leq 7$. Hence the total distance traveled is the sum of the distances traveled on each of these three intervals.

$$d = |x(1) - x(0)| + |x(3) - x(1)| + |x(7) - x(3)| = 4 + 4 + 112 = 120$$

14 p

36. Find the values of the constants a and b so that the following function is continuous at $x = 0$. If this is not possible, explain why.

$$f(x) = \begin{cases} \frac{4 - \sqrt{16 + 49x^2}}{ax^2} & x < 0 \\ -23 & x = 0 \\ \frac{\tan(2bx)}{x} & x > 0 \end{cases}$$

In your work, you must use limit-based methods to solve this problem. Solutions that have work that is not based on limits will not receive full credit.

Solution

We require that the left-limit, right-limit, and function value all be equal to $x = 0$. We have the following.

$$\begin{aligned}\lim_{x \rightarrow 0^-} f(x) &= \lim_{x \rightarrow 0^-} \left(\frac{4 - \sqrt{16 + 49x^2}}{ax^2} \right) = \lim_{x \rightarrow 0^-} \left(\frac{16 - (16 + 49x^2)}{ax^2(4 + \sqrt{16 + 49x^2})} \right) \\ &= \lim_{x \rightarrow 0^-} \left(\frac{-49}{a(4 + \sqrt{16 + 49x^2})} \right) = \frac{-49}{a(4 + \sqrt{16 + 0})} = -\frac{49}{8a} \\ \lim_{x \rightarrow 0^+} f(x) &= \lim_{x \rightarrow 0^+} \left(\frac{\tan(2bx)}{x} \right) = \lim_{x \rightarrow 0^+} \left(\frac{\sin(2bx)}{2bx} \cdot \frac{2b}{\cos(2bx)} \right) \\ &= \left(\lim_{x \rightarrow 0^+} \frac{\sin(2bx)}{2bx} \right) \left(\lim_{x \rightarrow 0^+} \frac{2b}{\cos(2bx)} \right) = 1 \cdot \frac{2b}{1} = 2b \\ f(0) &= -23\end{aligned}$$

Hence we must have that

$$-\frac{49}{8a} = -23 = 2b$$

and so the constants a and b are:

$$a = \frac{49}{184}, \quad b = -\frac{23}{2}$$

12 p

37. Let $f(x) = \frac{1}{3}x^3$ and let $g(x) = x^2 + 15x - 3$. Find all values of a for which the tangent lines to $y = f(x)$ and $y = g(x)$ at $x = a$ are parallel.

Solution

If the tangent lines at $x = a$ are parallel, then their slopes are equal, whence it follows that we must solve the equation $f'(a) = g'(a)$.

$$f'(a) = g'(a) \implies a^2 = 2a + 15 \implies 0 = a^2 - 2a - 15 = (a + 3)(a - 5)$$

Hence $a = -3$ or $a = 5$.

8 p

38. Calculate $f'(x)$ where f is the function below.

$$f(x) = \left(\frac{x^8 \sin(3x)}{\ln(x) - \ln(11)} \right)^{2/3}$$

After calculating the derivative, do not simplify your answer.

Solution

Use power rule, followed by chain rule. The derivative of the expression inside the power " $\frac{2}{3}$ " is given by quotient rule.

$$f'(x) = \frac{2}{3} \left(\frac{x^8 \sin(3x)}{\ln(x) - \ln(11)} \right)^{-1/3} \cdot \frac{(\ln(x) - \ln(11))(8x^7 \sin(3x) + 3x^8 \cos(3x)) - x^8 \sin(3x) \cdot \frac{1}{x}}{(\ln(x) - \ln(11))^2}$$

39. Suppose f and g are differentiable for all x . For each part, use the table below or explain why there is not enough information.

x	$f(x)$	$f'(x)$	$g(x)$	$g'(x)$
0	-1	-4	4	2
1	-1	-3	2	-4
2	-4	3	1	-1

8 p

- (a) Let $F(x) = \frac{f(x)}{g(x)}$. Calculate $F'(0)$.

8 p

- (b) Let $G(x) = f(xg(x))$. Calculate $G'(1)$.

Solution

- (a) First use quotient rule.

$$F'(x) = \frac{f'(x)g(x) - f(x)g'(x)}{g(x)^2}$$

Now substitute $x = 0$ and use the table of values.

$$F'(0) = \frac{(-4)(4) - (-1)(2)}{4^2} = \frac{-16 + 2}{16} = -\frac{7}{8}$$

- (b) First use chain rule, then product rule.

$$\begin{aligned} G'(x) &= \frac{d}{dx} f(xg(x)) = f'(xg(x)) \cdot \frac{d}{dx}(xg(x)) \\ &= f'(xg(x)) \cdot (1 \cdot g(x) + xg'(x)) \end{aligned}$$

Now substitute $x = 1$ and use the table of values.

$$\begin{aligned} G'(1) &= f'(1 \cdot g(1)) \cdot (g(1) + 1 \cdot g'(1)) \\ &= f'(2) \cdot (g(1) + g'(1)) \\ &= 3 \cdot (2 + (-4)) = -6 \end{aligned}$$

Midterm Exam #2

14 p

40. For each part, calculate the limit or show that it does not exist. If the limit is “ $+\infty$ ” or “ $-\infty$ ”, write that as your answer, instead of “does not exist”.

(a) $\lim_{x \rightarrow 0} \left(\frac{1 - \cos(9x)}{x^2} \right)$

(b) $\lim_{x \rightarrow 0} (1 - 3x)^{5/x}$

Solution

(a) Direct substitution of $x = 0$ gives the indeterminate form $\frac{0}{0}$, whence we may use L'Hospital's Rule (twice).

$$\lim_{x \rightarrow 0} \left(\frac{1 - \cos(9x)}{x^2} \right) \stackrel{H}{=} \lim_{x \rightarrow 0} \left(\frac{9 \sin(9x)}{2x} \right) \stackrel{H}{=} \lim_{x \rightarrow 0} \left(\frac{81 \cos(9x)}{2} \right) = \frac{81}{2}$$

(b) Direct substitution of $x = 0$ gives the indeterminate form $1^{\pm\infty}$, whence we let L be the desired limit and consider $\ln(L)$.

$$\ln(L) = \ln \left(\lim_{x \rightarrow 0} (1 - 3x)^{5/x} \right) = \lim_{x \rightarrow 0} \ln \left((1 - 3x)^{5/x} \right) = \lim_{x \rightarrow 0} \left(\frac{5 \ln(1 - 3x)}{x} \right)$$

Direct substitution of $x = 0$ now gives the indeterminate form $\frac{0}{0}$, whence we may use L'Hospital's Rule.

$$\lim_{x \rightarrow 0} \left(\frac{5 \ln(1 - 3x)}{x} \right) \stackrel{H}{=} \lim_{x \rightarrow 0} \left(\frac{5 \cdot \frac{1}{1-3x} \cdot (-3)}{1} \right) = -15$$

Hence $\ln(L) = -15$, and so $L = e^{-15}$.

12 p

41. Find an equation of the line tangent to the following curve at $(8, 1)$.

$$\sin \left(\frac{\pi x}{y} \right) = x - 8y$$

Solution

We implicitly differentiate each side of the equation with respect to x .

$$\cos \left(\frac{\pi x}{y} \right) \cdot \left(\frac{y \cdot \pi - \pi x \cdot \frac{dy}{dx}}{y^2} \right) = 1 - 8 \frac{dy}{dx}$$

Now we substitute the point $(x, y) = (8, 1)$.

$$1 \cdot \left(\frac{\pi - 8\pi \frac{dy}{dx}}{1} \right) = 1 - 8 \frac{dy}{dx}$$

Solving for $\frac{dy}{dx}$ gives $\frac{dy}{dx} = \frac{1}{8}$, the slope of the desired tangent line. Hence an equation of the tangent line is

$$y - 1 = \frac{1}{8}(x - 8)$$

14 p

42. A person 5 feet tall stands stationary 8 feet from the point P , which is directly beneath a lantern that falls toward the ground. At the moment when the lantern is 15 feet above the ground, the lantern is falling at a speed of 4 feet per second. At what rate is the length of the person's shadow changing at this moment?

You must give correct units as part of your answer.

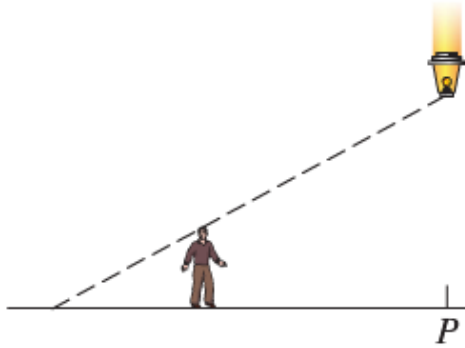

Solution

Let x be the distance from the person to the tip of the person's shadow and let h be the height of the lantern above the ground. Then by similar triangles, we have the relation

$$\frac{h}{5} = \frac{x+8}{x} = 1 + \frac{8}{x}$$

This relation holds for all time, and so we may differentiate this equation with respect to time t to obtain an equation involving rates of change which also holds for all time.

$$\frac{1}{5} \frac{dh}{dt} = -\frac{8}{x^2} \frac{dx}{dt}$$

We now substitute the values of the variables at the specific time: $h = 15$ and $\frac{dh}{dt} = -4$.

$$\begin{aligned} 3 &= 1 + \frac{8}{x} \\ -\frac{4}{5} &= -\frac{8}{x^2} \frac{dx}{dt} \end{aligned}$$

Solving for x in the first of these equations gives $x = 4$. Substituting $x = 4$ into the second equation and solving for $\frac{dx}{dt}$ gives $\frac{dx}{dt} = \frac{8}{5} = 1.6$. Hence the length of the person's shadow is changing at a rate of 1.6 feet per second.

10 p

43. The concentration of a certain drug in the bloodstream t hours after the drug is injected is modeled by the following formula.

$$C(t) = \frac{100t}{t^2 + 1}$$

(The concentration is measured in micrograms per milliliter.) Use a linear approximation to estimate the change in the concentration over the time period from 2 to 2.1 hours after injection. Also indicate whether the concentration increases or decreases.

Solution

We use the tangent line to $C(t)$ at $t = 2$. Observe that

$$C'(t) = \frac{(t^2 + 1) \cdot 100 - 100t \cdot 2t}{(t^2 + 1)^2} = \frac{-100(t^2 - 1)}{(t^2 + 1)^2}$$

whence $C'(2) = -12$. The desired tangent line is:

$$y - C(2) = -12(t - 2)$$

(Note that we don't need the value of $C(2)$.) The required estimate of $\Delta C = C(2.1) - C(2)$ is obtained by substituting $t = 2.1$ into our tangent line.

$$\Delta C = C(2.1) - C(2) \approx -12(2.1 - 2) = -1.2$$

So the concentration decreases by approximately 1.2 micrograms per milliliter.

44. Consider the function f and its derivatives below.

$$f(x) = \frac{2x^3 + 3x^2 - 1}{x^3}, \quad f'(x) = \frac{3 - 3x^2}{x^4}, \quad f''(x) = \frac{6x^2 - 12}{x^5}$$

For each part, write "NONE" as your answer if appropriate. Where applicable, give a comma-separated list of intervals that are as inclusive as possible.

4 p

(a) Find all horizontal asymptotes of f .

3 p

(b) Find all vertical asymptotes of f . Then at each vertical asymptote you find, calculate the corresponding one-sided limits of f .

7 p

(c) Find where f is decreasing and find where f is increasing. Then calculate the x -coordinates of all points of local extrema.

7 p

(d) Find where f is concave down and find where f is concave up. Then calculate the x -coordinates of all points of inflection.

Solution

(a) Horizontal asymptotes are found by computing the limit of f as $x \rightarrow \pm\infty$.

$$\lim_{x \rightarrow \pm\infty} \left(\frac{2x^3 + 3x^2 - 1}{x^3} \right) = \lim_{x \rightarrow \pm\infty} \left(2 + \frac{3}{x} - \frac{1}{x^3} \right) = 2 + 0 - 0 = 2$$

Hence the only horizontal asymptote is the line $y = 2$.

(b) Since f is continuous on its domain, the only candidate vertical asymptote is the line $x = 0$ (found by setting the denominator of f equal to 0). Direct substitution of $x = 0$ into $f(x)$ gives the expression $\frac{-1}{0}$, which indicates that the corresponding one-sided limits at $x = 0$ are infinite. Hence the line $x = 0$ is a true vertical asymptote. Now we may compute the limits using sign analysis.

$$\begin{aligned} \lim_{x \rightarrow 0^-} \left(\frac{2x^3 + 3x^2 - 1}{x^3} \right) &= \frac{-1}{0^-} = +\infty \\ \lim_{x \rightarrow 0^+} \left(\frac{2x^3 + 3x^2 - 1}{x^3} \right) &= \frac{-1}{0^+} = -\infty \end{aligned}$$

(c) We calculate a sign chart for the first derivative. The cut points are the solutions to $f'(x) = 0$ ($x = -1$ and $x = 1$) and the vertical asymptotes ($x = 0$).

interval	test point	sign of f'	shape of f
$(-\infty, -1)$	$f'(-2)$	$\ominus = \ominus$	decreasing
$(-1, 0)$	$f'(-0.5)$	$\oplus = \oplus$	increasing
$(0, 1)$	$f'(0.5)$	$\oplus = \oplus$	increasing
$(1, \infty)$	$f'(2)$	$\ominus = \ominus$	decreasing

Hence we deduce the following about f :

$$\begin{aligned}
 f \text{ is decreasing on:} & \quad (-\infty, -1], [1, \infty) \\
 f \text{ is increasing on:} & \quad [-1, 0), (0, 1] \\
 f \text{ has a local min at:} & \quad x = -1 \\
 f \text{ has a local max at:} & \quad x = 1
 \end{aligned}$$

- (d) We calculate a sign chart for the second derivative. The cut points are the solutions to $f''(x) = 0$ ($x = -\sqrt{2}$ and $x = \sqrt{2}$) and the vertical asymptotes ($x = 0$).

interval	test point	sign of f''	shape of f
$(-\infty, -\sqrt{2})$	$f'(-2)$	$\ominus = \ominus$	concave down
$(-\sqrt{2}, 0)$	$f'(-1)$	$\oplus = \oplus$	concave up
$(0, \sqrt{2})$	$f'(1)$	$\ominus = \ominus$	concave down
$(\sqrt{2}, \infty)$	$f'(2)$	$\oplus = \oplus$	concave up

Hence we deduce the following about f :

$$\begin{aligned}
 f \text{ is concave down on:} & \quad (-\infty, -\sqrt{2}], (0, \sqrt{2}] \\
 f \text{ is concave up on:} & \quad [-\sqrt{2}, 0), [\sqrt{2}, \infty) \\
 f \text{ has an infl. point at:} & \quad x = -\sqrt{2}, x = \sqrt{2}
 \end{aligned}$$

45. Let $f(x) = 4(x-3)^{1/3} - \frac{1}{3}x + 1$. Note: The domain of f is $(-\infty, \infty)$.

11 p

- (a) Calculate all critical points of f . For each number you find, you must clearly indicate in your work why it is a critical point.

4 p

- (b) What are the absolute extreme values of f on the interval $[2, 30]$?

Solution

- (a) Note that f is continuous for all x . So the critical points of f are those values of x for which either $f'(x)$ does not exist or $f'(x) = 0$. We first note that $(x-3)^{1/3}$ is not differentiable at $x = 3$, hence $x = 3$ is a critical number of f . The derivative is

$$f'(x) = \frac{4}{3}(x-3)^{-2/3} - \frac{1}{3}$$

Solving the equation $f'(x) = 0$ gives us the solutions $x = -5$ and $x = 11$. So, in summary, f has three critical points: $x = -5$, $x = 3$, and $x = 11$.

- (b) Now we find the values of f at the critical points (in the interval) and endpoints of the interval.

x	2	3	11	30
$f(x)$	$-\frac{11}{3}$	0	$\frac{16}{3}$	3

Hence the absolute minimum is $-\frac{11}{3}$ and the absolute maximum is $\frac{16}{3}$.

14 p

46. Find the maximum possible area of a rectangle inscribed in the region between the graph of $f(x) = e^{-x^2/12}$ and the x -axis. You must use calculus-based methods in your work. You must also justify that your answer really does give the maximum.

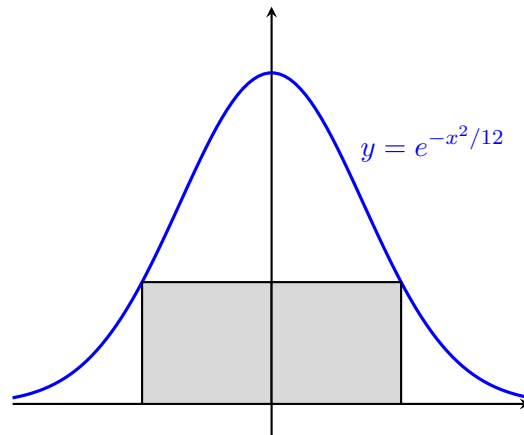

Solution

Let the upper right vertex of the rectangle be the point (a, b) , so that the width of the rectangle is $2a$ and the height is b . Hence the area is

$$A(a, b) = 2ab$$

Since the point (a, b) lies on the graph of $y = f(x)$, we have that $b = e^{-a^2/12}$. Hence our goal is to find the maximum value of the function

$$g(a) = 2ae^{-a^2/12}$$

on the interval $[0, \infty)$. Since g is differentiable on its domain, the only critical points are solutions to $g'(a) = 0$. First we calculate and simplify $g'(a)$.

$$g'(a) = 2 \cdot e^{-a^2/12} + 2a \cdot e^{-a^2/12} \cdot \frac{-a}{6} = 2e^{-a^2/12} \left(1 - \frac{a^2}{6}\right)$$

Now we solve $g'(a) = 0$. (Observe that $e^{-a^2/12} > 0$ for all $a > 0$.)

$$g'(a) = 0 \implies 1 - \frac{a^2}{6} = 0 \implies a = -\sqrt{6}, \sqrt{6}$$

The only critical point in the interval $[0, \infty)$ is $a = \sqrt{6}$.

Now we examine the nature of this critical point using the first derivative test.

interval	test point	sign of $g'(x)$	shape of g
$[0, \sqrt{6})$	$g'(1)$	$2\oplus\oplus = \oplus$	increasing
$(\sqrt{6}, \infty)$	$g'(3)$	$2\oplus\ominus = \ominus$	decreasing

Hence g is increasing on $[0, \sqrt{6}]$ and decreasing on $[\sqrt{6}, \infty)$, whence a local maximum of g occurs at $x = \sqrt{6}$. Since $x = \sqrt{6}$ is the only critical point, this local maximum must be a global maximum.

Hence the maximum area is $g(\sqrt{6}) = 2\sqrt{\frac{6}{e}}$.

1.4 Spring 2019

Midterm Exam #1

10 p

47. For each part, mark “T” if the statement is true or mark “F” if the statement is false. You do not have to explain your answers or show any work.

(a) T F $\ln(3) - \ln(11) = \frac{\ln(3)}{\ln(11)}$

(b) T F The domain of $f(x) = \sqrt[3]{x-4}$ is all real numbers.

(c) T F The lines $9x + y = 1$ and $x - 9y = 4$ are perpendicular to each other.

(d) T F The equations $2\ln(x) = 0$ and $\ln(x^2) = 0$ have the same solutions.

(e) T F $\cos\left(\frac{5\pi}{6}\right) = -\frac{\sqrt{3}}{2}$

Solution

(a) **False.** The correct identity is $\ln(3) - \ln(11) = \ln\left(\frac{3}{11}\right)$.

(b) **True.** Every real number has an odd root.

(c) **True.** The slope of the line $9x + y = 1$ is $m_1 = -9$ and the slope of the line $x - 9y = 4$ is $m_2 = \frac{1}{9}$. Since $m_1 m_2 = -1$, the lines are perpendicular.

(d) **False.** The equation $2\ln(x) = 0$ has solution $x = 1$. The equation $\ln(x^2) = 0$ has solutions $x = 1$ and $x = -1$. (The identity $\ln(x^b) = b\ln(x)$ is true only if $x > 0$.)

(e) **True.** The reference angle for $\frac{5\pi}{6}$ is $\frac{\pi}{6}$, and $\cos\left(\frac{\pi}{6}\right) = \frac{\sqrt{3}}{2}$. Since the angle $\frac{5\pi}{6}$ lies in the second quadrant, its cosine is negative.

5 p

48. The number N of bacteria at time t grows exponentially, so that $N(t) = N_0 e^{kt}$. Suppose an initial population of 100 bacteria grows to 500 after 2 hours. How many hours does it take for an initial population of 150 bacteria to grow to 300?

Solution

We are given that if $N_0 = 100$ then $N(2) = 500$. Hence $500 = 100e^{2k}$, and solving for k gives $k = \frac{1}{2}\ln(5)$. Now we want to solve the equation $300 = 150e^{kt}$ for t with the known value of k . This gives $t = \frac{2\ln(2)}{\ln(5)}$.

10 p

49. For each part, calculate the limit or show that it does not exist. If the limit is “ $+\infty$ ” or “ $-\infty$ ”, write that as your answer, instead of “does not exist”.

(a) $\lim_{x \rightarrow 5} \left(\frac{x-5}{x^2-2x-15} \right)$

(b) $\lim_{x \rightarrow 0} \left(\frac{\sin(9x)}{\sin(16x)} \right)$

Solution

(a) Cancel common factors.

$$\lim_{x \rightarrow 5} \left(\frac{x-5}{x^2-2x-15} \right) = \lim_{x \rightarrow 5} \left(\frac{x-5}{(x-5)(x+3)} \right) = \lim_{x \rightarrow 5} \left(\frac{1}{x+3} \right) = \frac{1}{8}$$

(b) Use the special limit $\lim_{\theta \rightarrow 0} \left(\frac{\sin(\theta)}{\theta} \right) = 1$ and some algebra.

$$\lim_{x \rightarrow 0} \left(\frac{\sin(9x)}{\sin(16x)} \right) = \lim_{x \rightarrow 0} \left(\frac{\sin(9x)}{9x} \cdot \frac{16x}{\sin(16x)} \cdot \frac{9}{16} \right) = 1 \cdot 1 \cdot \frac{9}{16} = \frac{9}{16}$$

15 p 50. For each part, calculate $f'(x)$. Do not simplify your answers.

(a) $f(x) = e^x \sin(x)$

(b) $f(x) = \frac{\ln(e^{4x} + 6)}{9 \tan(x) - \pi^9}$

Solution

(a) Use product rule.

$$f'(x) = e^x \sin(x) + e^x \cos(x)$$

(b) Start with quotient rule. To differentiate the numerator, use chain rule twice.

$$f'(x) = \frac{\left(\frac{1}{e^{4x} + 6} \cdot e^{4x} \cdot 4 \right) (9 \tan(x) - \pi^9) - \ln(e^{4x} + 6) \cdot 9 \sec(x)^2}{(9 \tan(x) - \pi^9)^2}$$

5 p 51. Find the slope of the line tangent to the graph of $y = 3 \ln(x) - 6\sqrt{x}$ at $x = 3$.

Solution

Observe that

$$\frac{dy}{dx} = 3 \cdot \frac{1}{x} - 6 \cdot \frac{1}{2} x^{-1/2} = \frac{3}{x} - \frac{3}{\sqrt{x}}$$

Hence the slope of the tangent line is

$$\left. \frac{dy}{dx} \right|_{x=3} = \frac{3}{3} - \frac{3}{\sqrt{3}} = 1 - \sqrt{3}$$

5 p 52. Find the value of k that makes $f(x)$ continuous at $x = 1$. If no such value of k exists, write “does not exist”.

$$f(x) = \begin{cases} k \cos(\pi x) - 3x^2 & x \leq 1 \\ 8e^x - k \ln(x) & x > 1 \end{cases}$$

Solution

We require that the left-limit, right-limit, and function value at $x = 1$ be equal to ensure continuity at $x = 1$.

$$\lim_{x \rightarrow 1^-} f(x) = \lim_{x \rightarrow 1^-} (k \cos(\pi x) - 3x^2) = k \cos(\pi) - 3 = -k - 3$$

$$\lim_{x \rightarrow 1^+} f(x) = \lim_{x \rightarrow 1^+} (8e^x - k \ln(x)) = 8e^1 - k \ln(1) = 8e$$

$$f(1) = (k \cos(\pi x) - 3x^2)|_{x=1} = k \cos(\pi) - 3 = -k - 3$$

Hence we must have $-k - 3 = 8e$, or $k = -8e - 3$.

- 5 p** 53. Suppose $f(4) = -8$ and $f'(4) = 3$. Let $g(x) = f\left(\frac{1}{4}x^2\right)$. Find $g'(4)$ or explain why it is impossible to do so with the given information.

Solution

Use chain rule.

$$g'(x) = f'\left(\frac{1}{4}x^2\right) \cdot \frac{1}{2}x$$

Hence $g'(4) = f'(4) \cdot 2 = 6$.

- 5 p** 54. The graph of $y = f(x)$ is given below. Find all values of a in the interval $(-4, 4)$ for which $\lim_{x \rightarrow a} f(x)$ does not exist. If there are no such values of a , write “does not exist”.

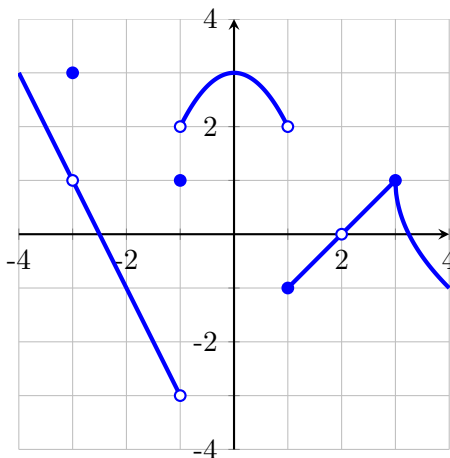
**Solution**

The values of a for which $\lim_{x \rightarrow a} f(x)$ does not exist are $a = -1$ and $a = 1$ only. (At both of these values of a , the left-limit and right-limit are not equal.)

- 10 p** 55. Find an equation of the line tangent to the following curve at the point $(1, 1)$.

$$\frac{5x}{y} = 4x + y^3$$

Solution

Differentiate each side of the equation with respect to x using implicit differentiation.

$$\frac{5 \cdot y - 5x \cdot \frac{dy}{dx}}{y^2} = 4 + 3y^2 \cdot \frac{dy}{dx}$$

Substituting the point $(x, y) = (1, 1)$ gives $5 - 5 \frac{dy}{dx} = 4 + 3 \frac{dy}{dx}$, whence $\frac{dy}{dx} = \frac{1}{8}$. Hence the tangent line has equation

$$y - 1 = \frac{1}{8}(x - 1)$$

10 p

56. Let $g(x) = 6 - \frac{9}{x}$. Calculate $g'(3)$ directly from the limit definition of the derivative. *If you simply quote a rule, you will receive no credit. You must use the definition of derivative.*

Solution

Start with the definition of derivative and compute the limit using algebra.

$$\begin{aligned} g'(3) &= \lim_{h \rightarrow 0} \left(\frac{g(3+h) - g(3)}{h} \right) = \lim_{h \rightarrow 0} \left(\frac{\left(6 - \frac{9}{3+h}\right) - \left(6 - \frac{9}{3}\right)}{h} \right) = \lim_{h \rightarrow 0} \left(\frac{3 - \frac{9}{3+h}}{h} \right) \\ &= \lim_{h \rightarrow 0} \left(\frac{3(3+h) - 9}{h(3+h)} \right) = \lim_{h \rightarrow 0} \left(\frac{3h}{h(3+h)} \right) = \lim_{h \rightarrow 0} \left(\frac{3}{3+h} \right) = \frac{3}{3+0} = 1 \end{aligned}$$

10 p

57. Show that the following equation is satisfied for at least one value of x in the interval $(0, 1)$.

$$\sqrt{12x^4 + 9x^2 + 4} = 4x^3 + 2x$$

You must identify any theorem you use by name and clearly justify its use.

Solution

Equivalently, we show that the equation $\sqrt{12x^4 + 9x^2 + 4} - 4x^3 - 2x = 0$ has a solution in the interval $(0, 1)$. To that end, let $f(x) = \sqrt{12x^4 + 9x^2 + 4} - 4x^3 - 2x$. Observe that f is continuous on $[0, 1]$, $f(0) = 2$, and $f(1) = -1$. Since 0 is a value between $f(0)$ and $f(1)$, the Intermediate Value Theorem (IVT) guarantees that $f(x) = 0$ has a solution in $(0, 1)$.

10 p

58. Consider the function $f(x)$ below.

$$f(x) = \begin{cases} \frac{4 - \sqrt{2x + 10}}{x - 3} & x \neq 3 \\ 1 & x = 3 \end{cases}$$

Is $f(x)$ continuous at $x = 3$? Explain your answer. *In your work, you must use limit-based methods to solve this problem. Solutions that have work that is not based on limits will not receive full credit.*

Solution

First we calculate the limit of $f(x)$ as $x \rightarrow 3$.

$$\begin{aligned} \lim_{x \rightarrow 3} f(x) &= \lim_{x \rightarrow 3} \left(\frac{4 - \sqrt{2x + 10}}{x - 3} \right) = \lim_{x \rightarrow 3} \left(\frac{4 - \sqrt{2x + 10}}{x - 3} \cdot \frac{4 + \sqrt{2x + 10}}{4 + \sqrt{2x + 10}} \right) \\ &= \lim_{x \rightarrow 3} \left(\frac{16 - (2x + 10)}{(x - 3)(4 + \sqrt{2x + 10})} \right) = \lim_{x \rightarrow 3} \left(\frac{-2(x - 3)}{(x - 3)(4 + \sqrt{2x + 10})} \right) \\ &= \lim_{x \rightarrow 3} \left(\frac{-2}{4 + \sqrt{2x + 10}} \right) = \frac{-2}{4 + \sqrt{2 \cdot 3 + 10}} = -\frac{1}{4} \end{aligned}$$

Observe that $\lim_{x \rightarrow 3} f(x) \neq f(3) = 1$, and so f is not continuous at $x = 3$.

Midterm Exam #2

11 p

59. Find all critical points of $f(x) = x - \frac{3}{2}(x - 8)^{2/3}$ or explain why f has no critical points.

Solution

The first derivative is

$$f'(x) = 1 - (x - 8)^{-1/3} = 1 - \frac{1}{(x - 8)^{1/3}}$$

Critical points are values of x at which f is not differentiable ($x = 8$ only) or where $f'(x) = 0$ ($x = 9$ only, see below).

$$1 - \frac{1}{(x - 8)^{1/3}} = 0 \implies 1 = (x - 8)^3 \implies 1 = x - 8 \implies x = 9$$

5 p

60. Use a linear approximation to estimate the value of $\sqrt{35.9}$. Do not simplify your answer.

Solution

We use the tangent line to $f(x) = \sqrt{x}$ at $x = 36$. Observe that $f(36) = 6$ and $f'(x) = \frac{1}{2}x^{-1/2}$, whence $f'(36) = \frac{1}{12}$. The desired tangent line is:

$$y = 6 + \frac{1}{12}(x - 36)$$

If x is near 36, then the y -values of the tangent line are approximately equal to \sqrt{x} . So we have

$$\sqrt{35.9} \approx 6 + \frac{1}{12}(35.9 - 36) = 6 - \frac{1}{120}$$

5 p

61. The cost of producing x units is $C(x) = 3x^2 + 4x + 1000$. Use marginal analysis to estimate the cost of producing the 41st unit.

Solution

The approximate cost of the 41st unit is given by $C'(40)$.

$$C'(40) = (6x + 4)|_{x=40} = 6 \cdot 40 + 4 = 244$$

11 p

62. The cost of producing x units is $C(x) = 2x^2 + 5x + 8$. Find the level of production (value of x) that minimizes the average cost. *Hint:* Average cost is $AC(x) = \frac{C(x)}{x}$.

Solution

The average cost is $AC(x) = 2x + 5 + \frac{8}{x}$. The critical points are solutions to $AC'(x) = 0$.

$$0 = AC'(x) = 2 - \frac{8}{x^2} \implies x = 2$$

(We have rejected the solution $x = -2$ since level of production must be non-negative.) Since $AC''(x) = \frac{16}{x^3} > 0$ for all $x > 0$, we see that $x = 2$ gives the minimum value of AC .

11 p

63. Find the equation of each horizontal asymptote, if any, of $f(x) = \frac{4x^3 - 3x^2}{2x^3 + 9x + 1}$.

Solution

We must compute the limit of f as $x \rightarrow \pm\infty$. If $x \neq 0$, we have

$$f(x) = \frac{4 - \frac{3}{x}}{2 + \frac{9}{x^2} + \frac{1}{x^3}}$$

So as $x \rightarrow \pm\infty$, each reciprocal power of x has limit 0. So both limits at infinity are $\frac{4}{2} = 2$. Hence the equation of the (only) horizontal asymptote is $y = 2$.

18 p

64. Consider the function f and its derivatives below.

$$f(x) = 2x + \frac{8}{x^2}, \quad f'(x) = \frac{2(x^3 - 8)}{x^3}, \quad f''(x) = \frac{48}{x^4}$$

Fill in the table below with information about the graph of $y = f(x)$. For each part, write "NONE" as your answer if appropriate. Where applicable, give a comma-separated list of intervals that are as inclusive as possible.

You do not have to show work, and each table item will be graded with no partial credit.

Solution

equation(s) of vertical asymptote(s) of f	$x = 0$
equation(s) of horizontal asymptote(s) of f	NONE
where f is decreasing	$(0, 2]$
where f is increasing	$(-\infty, 0), [2, \infty)$
x -coordinate(s) of local minima of f	$x = 2$
x -coordinate(s) of local maxima of f	NONE
where f is concave down	NONE
where f is concave up	$(-\infty, 0), (0, \infty)$
x -coordinate(s) of inflection point(s) of f	NONE

The derivatives of f are

$$f(x) = 2x + \frac{8}{x^2}, \quad f'(x) = \frac{2(x^3 - 8)}{x^3}, \quad f''(x) = \frac{48}{x^4}$$

- (i) Vertical asymptotes and horizontal asymptotes.

Observe that f is continuous on its domain, but is undefined for $x = 0$. Hence our candidate vertical asymptote is the line $x = 0$. Indeed, direct substitution of $x = 0$ into the term $\frac{8}{x^2}$ gives the expression $\frac{8}{0}$, which indicates that both one-sided limits are infinite. Hence the line $x = 0$ is a true vertical asymptote.

As for the horizontal asymptotes we have the following.

$$\lim_{x \pm \infty} \left(2x + \frac{8}{x^2} \right) = \pm\infty + 0 = \pm\infty$$

Since neither limit (as either $x \rightarrow -\infty$ or $x \rightarrow \infty$) is finite, there are no horizontal asymptotes.

(ii) *Intervals of increase and local extrema.*

We calculate a sign chart for the first derivative. The cut points are the solutions to $f'(x) = 0$ ($x = 2$) and the vertical asymptotes ($x = 0$).

interval	test point	sign of f'	shape of f
$(-\infty, 0)$	$f'(-1)$	$\frac{2\ominus}{\oplus} = \oplus$	increasing
$(0, 2)$	$f'(1)$	$\frac{2\ominus}{\oplus} = \ominus$	decreasing
$(2, \infty)$	$f'(3)$	$\frac{2\oplus}{\oplus} = \oplus$	increasing

Hence we deduce the following about f :

f is decreasing on: $(0, 2]$
 f is increasing on: $(-\infty, 0), [2, \infty)$
 f has a local min at: $x = 2$
 f has a local max at: *none*

(iii) *Intervals of concavity and inflection points.*

We calculate a sign chart for the second derivative: The cut points are the solutions to $f''(x) = 0$ (none) and the vertical asymptotes ($x = 0$).

interval	test point	sign of f''	shape of f
$(-\infty, 0)$	$f''(-1)$	$\frac{48}{\oplus} = \oplus$	concave up
$(0, \infty)$	$f''(1)$	$\frac{48}{\oplus} = \oplus$	concave up

Hence we deduce the following about f :

f is concave down on: *no interval*
 f is concave up on: $(-\infty, 0), (0, \infty)$
 f has an infl. point at: *none*

(iv) *Sketch of graph.*

Not required.

65. A child flies a kite at a constant height of 30 feet and the wind is carrying the kite horizontally away from the child at a rate of 5 ft./sec. At what rate must the child let out the string when the kite is 50 feet away from the child?

You must give correct units as part of your answer.

Solution

Let L be the distance from the child to the kite and let x be the horizontal distance from the child to the kite. Then, for all time, we have

$$x^2 + 30^2 = L^2$$

Differentiating with respect to time t gives

$$2x \frac{dx}{dt} = 2L \frac{dL}{dt} \implies x \frac{dx}{dt} = L \frac{dL}{dt}$$

At the time of interest, we have that $\frac{dx}{dt} = 5$ and $L = 50$. Hence, at that time, we have the following.

$$\begin{aligned} x^2 + 900 &= 2500 \\ 5x &= 50 \frac{dL}{dt} \end{aligned}$$

The first equation gives $x = 40$, and substitution of $x = 40$ into the second equation gives $\frac{dL}{dt} = 4$. Hence the child must let the string out at a rate of 4 ft./sec.

11 p

66. Find the absolute extreme values of $f(x) = \frac{20x}{x^2 + 4}$ on $[-4, 0]$.

Solution

Since f is differentiable everywhere, the only critical points are solutions to $f'(x) = 0$.

$$0 = f'(x) = \frac{(x^2 + 4)(20) - (20x)(2x)}{(x^2 + 4)^2} = \frac{-20x^2 + 80}{(x^2 + 4)^2} \implies x = -2 \text{ or } x = 2$$

Now we find the values of f at the critical points and endpoints of the interval.

x	-4	-2	0
$f(x)$	-4	-5	0

Hence the absolute minimum is -5 and the absolute maximum is 0 .

67. The parts of this problem *are* related!

3 p

(a) Show that $\lim_{x \rightarrow \infty} \left(\frac{x}{x-3} \right) = 1$.

8 p

(b) Calculate the following limit or show it does not exist.

$$\lim_{x \rightarrow \infty} \left(\frac{x}{x-3} \right)^x$$

Hint: First use part (a) to identify the appropriate indeterminate form.

Solution

(a) We have the following.

$$\lim_{x \rightarrow \infty} \left(\frac{x}{x-3} \right) = \lim_{x \rightarrow \infty} \left(\frac{1}{1 - \frac{3}{x}} \right) = \frac{1}{1-0} = 1$$

(b) The result of part (a) implies that as $x \rightarrow \infty$, our limit has the indeterminate form 1^∞ . Let L be the desired limit. Then we have the following.

$$\ln(L) = \lim_{x \rightarrow \infty} \ln \left[\left(\frac{x}{x-3} \right)^x \right] = \lim_{x \rightarrow \infty} \left[x \ln \left(\frac{x}{x-3} \right) \right] = \lim_{x \rightarrow \infty} \left[\frac{\ln \left(\frac{x}{x-3} \right)}{\frac{1}{x}} \right]$$

As $x \rightarrow \infty$, we now have the indeterminate form $\frac{0}{0}$, so we may use L'Hospital's Rule.

$$\ln(L) \stackrel{H}{=} \lim_{x \rightarrow \infty} \left(\frac{\frac{x-3}{x} \cdot \frac{(x-3) \cdot 1 - x \cdot 1}{(x-3)^2}}{\frac{-1}{x^2}} \right) = \lim_{x \rightarrow \infty} \left(\frac{3x}{x-3} \right) = \lim_{x \rightarrow \infty} \left(\frac{3}{1 - \frac{3}{x}} \right) = 3$$

We have found that $\ln(L) = 3$, whence $L = e^3$.

11 p

68. According to postal regulations, the sum of the girth and length of a parcel may not exceed 90 inches. What are the dimensions (in inches) of the parcel with the largest possible volume that can be sent, if the parcel is a rectangular box with two square sides?

You must use calculus-based methods in your work. You must also justify that your answer really does give the maximum.

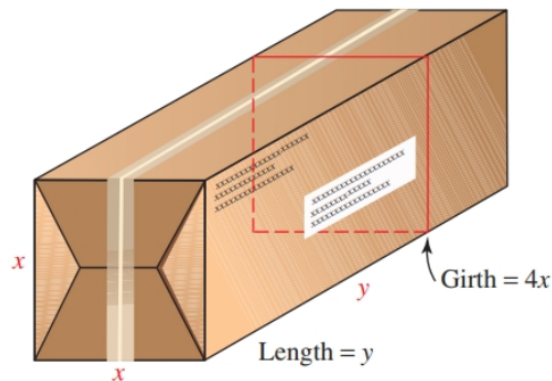
**Solution**

We want to find the absolute maximum value of the objective function $V(x, y) = x^2y$ (total volume) subject to the constraint $4x + y = 90$ (sum of girth and length must be 90). Solving for y in the constraint gives $y = 90 - 4x$, and so the total volume of the parcel is

$$f(x) = V(x, 90 - 4x) = x^2(90 - 4x) = 90x^2 - 4x^3$$

Note that the problem requires that $x \geq 0$ and $y \geq 0$. The condition $y \geq 0$ is equivalent to $90 - 4x \geq 0$, or $x \leq 22.5$. Hence our goal is to find the absolute maximum value of

$$f(x) = 90x^2 - 4x^3$$

on the interval $[0, 22.5]$. Since f is differentiable on this interval, the critical points are the solutions to $f'(x) = 0$.

$$0 = f'(x) = 180x - 12x^2 = 12x(15 - x) \implies x = 0 \text{ or } x = 15$$

Checking the endpoint values and critical value, we get: $f(0) = 0$, $f(22.5) = 0$, and $f(15) = 225 \cdot 30 > 0$. Hence the volume of the parcel has an absolute maximum when $x = 15$ and $y = 30$.

Alternatively...

Instead of finding the precise interval of allowed x -values, we may observe that the allowed interval is some subinterval of $[0, \infty)$ since lengths must be positive. Observe that

$$f''(x) = 180 - 24x = 12(15 - 2x)$$

and $f''(15) = 12 \cdot (-15) < 0$. Since $x = 15$ is the only critical number and $f''(15) < 0$, the second derivative test implies that f must have local (and hence global) maximum on $[0, \infty)$ at $x = 15$.

69. This problem asks about the Mean Value Theorem (MVT).

3 p

(a) Explain precisely why the function $f(x) = |3x - 6|$ does not satisfy the hypotheses of the MVT on the interval $[-1, 4]$.

6 p

(b) The function $f(x) = \sqrt{x}$ satisfies the hypotheses of the MVT on the interval $[0, 36]$. Find all values of c described by the MVT.

Solution

(a) The function f is not differentiable at $x = 2$ and 2 is in the interval $(-1, 4)$.

(b) We have to find all values of c in $(0, 36)$ that satisfy the equation

$$f'(c) = \frac{f(36) - f(0)}{36 - 0}$$

Hence we have

$$\frac{1}{2\sqrt{c}} = \frac{1}{6} \implies c = 9$$

1.5 Fall 2019

Midterm Exam #1

15 p

70. For each part, calculate the limit or show that it does not exist. If the limit is “ $+\infty$ ” or “ $-\infty$ ”, write that as your answer, instead of “does not exist”.

$$(a) \lim_{x \rightarrow 5} \left(\frac{x^2 - 3x - 10}{x^2 - x - 20} \right) \quad (b) \lim_{x \rightarrow 0} \left(\frac{\sin^2(4x)}{x^2} \right) \quad (c) \lim_{x \rightarrow 4} \left(\frac{3 - \sqrt{2x + 1}}{x - 4} \right)$$

Solution

(a) Cancel common factors.

$$\lim_{x \rightarrow 5} \left(\frac{x^2 - 3x - 10}{x^2 - x - 20} \right) = \lim_{x \rightarrow 5} \left(\frac{(x - 5)(x + 2)}{(x - 5)(x + 4)} \right) = \lim_{x \rightarrow 5} \left(\frac{x + 2}{x + 4} \right) = \frac{5 + 2}{5 + 4} = \frac{7}{9}$$

(b) Use the special limit $\lim_{\theta \rightarrow 0} \left(\frac{\sin(a\theta)}{a\theta} \right) = 1$.

$$\lim_{x \rightarrow 0} \left(\frac{\sin^2(4x)}{x^2} \right) = \left(\lim_{x \rightarrow 0} \frac{\sin(4x)}{x} \right)^2 = \left(\lim_{x \rightarrow 0} \left(\frac{\sin(4x)}{4x} \cdot 4 \right) \right)^2 = (1 \cdot 4)^2 = 16$$

(c) First rationalize the numerator.

$$\begin{aligned} \lim_{x \rightarrow 4} \left(\frac{3 - \sqrt{2x + 1}}{x - 4} \right) &= \lim_{x \rightarrow 4} \left(\frac{9 - (2x + 1)}{(x - 4)(3 + \sqrt{2x + 1})} \right) = \lim_{x \rightarrow 4} \left(\frac{-2(x - 4)}{(x - 4)(3 + \sqrt{2x + 1})} \right) \\ &= \lim_{x \rightarrow 4} \left(\frac{-2}{3 + \sqrt{2x + 1}} \right) = \frac{-2}{3 + \sqrt{9}} = -\frac{1}{3} \end{aligned}$$

10 p

71. For each part, calculate $f'(x)$. Do not simplify your answers.

$$(a) f(x) = \frac{\ln(x)}{10 - x^3} \quad (b) f(x) = \sqrt{\cos(3 + x^5)}$$

Solution

(a) Use quotient rule.

$$f'(x) = \frac{\frac{1}{x} \cdot (10 - x^3) - \ln(x) \cdot (-3x^2)}{(10 - x^3)^2}$$

(b) Use chain rule twice.

$$f'(x) = \frac{1}{2} (\cos(3 + x^5))^{-1/2} \cdot (-\sin(3 + x^5)) \cdot 5x^4$$

5 p

72. Solve the inequality $\frac{3x - 6}{x + 4} > 0$. Write your answer using interval notation.

Solution

We solve the inequality using the method of sign charts. The cut points for our number line are $x = 2$ (obtained by solving $3x - 6 = 0$) and $x = -4$ (obtained by solving $x + 4 = 0$).

interval	test point	sign of $\frac{3x-6}{x+4}$	truth of inequality
$(-\infty, -4)$	$x = -5$	$\ominus = \oplus$	true
$(-4, 2)$	$x = 0$	$\ominus = \ominus$	false
$(2, \infty)$	$x = 3$	$\oplus = \oplus$	true

The inequality is not satisfied at either cut point $x = -4$ or $x = 2$. Hence the solution to our inequality is the set $(-\infty, -4) \cup (2, \infty)$.

5 p

73. Find an equation of the line tangent to the graph of $y = \tan(2x)$ at $x = \frac{\pi}{8}$.

Solution

The tangent line must pass through the point $(\frac{\pi}{8}, f(\frac{\pi}{8})) = (\frac{\pi}{8}, \tan(\frac{\pi}{4})) = (\frac{\pi}{8}, 1)$. Now we find the derivative using chain rule.

$$f'(x) = \sec(2x)^2 \cdot 2$$

Hence the slope of the tangent line is $f'(\frac{\pi}{8}) = 2\sec(\frac{\pi}{4})^2 = 4$. The equation of the tangent line is:

$$y - 1 = 4\left(x - \frac{\pi}{8}\right)$$

5 p

74. Find all critical points of $f(x) = 2 - (x^2 - 2x)^{1/3}$ or explain why f has no critical points. **Note:** The domain of f is $(-\infty, \infty)$.

Solution

The first derivative of f is

$$f'(x) = \frac{-(2x - 2)}{3(x^2 - 2x)^{2/3}}$$

Critical points come in two types: where $f'(x)$ does not exist or where $f'(x) = 0$. Note that $f'(x)$ does not exist if $x^2 - 2x = 0$ (i.e., $x = 0$ or $x = 2$) and $f'(x) = 0$ if $x = 1$. Hence f has three critical points: $x = 0$, $x = 1$, and $x = 2$.

12 p

75. Let $f(x) = 2x^2 - 5x + 7$. Use the limit definition of the derivative to calculate $f'(x)$. *If you simply quote a rule, you will receive no credit. You must use the definition of derivative.*

Solution

Start with the definition of derivative and compute the limit using algebra.

$$\begin{aligned} f'(x) &= \lim_{h \rightarrow 0} \left(\frac{f(x+h) - f(x)}{h} \right) = \lim_{h \rightarrow 0} \left(\frac{2(x+h)^2 - 5(x+h) + 7 - (2x^2 - 5x + 7)}{h} \right) \\ &= \lim_{h \rightarrow 0} \left(\frac{2x^2 + 4xh + 2h^2 - 5x - 5h + 7 - 2x^2 + 5x - 7}{h} \right) = \lim_{h \rightarrow 0} \left(\frac{4xh + 2h^2 - 5h}{h} \right) \\ &= \lim_{h \rightarrow 0} \left(\frac{h(4x + 2h - 5)}{h} \right) = \lim_{h \rightarrow 0} (4x + 2h - 5) = 4x - 5 \end{aligned}$$

24 p

76. For each part, find the absolute extreme values of $f(x)$ on the given interval.

(a) $f(x) = x + \frac{9}{x}$ on $[1, 18]$.

(b) $f(x) = (6 - x)e^x$ on $[0, 6]$.

*(Hint: $2 < e < 3$.)***Solution**

- (a) We first find the critical points of
- f
- . Since
- f
- is differentiable on its domain, all critical points satisfy
- $f'(x) = 0$
- .

$$0 = f'(x) = 1 - \frac{9}{x^2} \implies x = -3 \text{ or } x = 3$$

The only critical point in $(1, 18)$ is $x = 3$. Now we compare the critical values and the endpoint values.

x	1	3	18
$f(x)$	10	6	18.5

Hence the absolute minimum is 6 and the absolute maximum is 18.5.

- (b) We first find the critical points of
- f
- . Since
- f
- is differentiable on its domain, all critical points satisfy
- $f'(x) = 0$
- .

$$0 = f'(x) = (5 - x)e^x \implies x = 5$$

Now we compare the critical values and the endpoint values.

x	0	5	6
$f(x)$	6	e^5	0

Hence the absolute minimum is 0 and the absolute maximum is e^5 .**12 p**

- 77.**
- Find all points on the graph of
- $f(x) = x \ln(x)$
- where the tangent line is horizontal.

SolutionA horizontal line has slope 0 and the slope of the tangent line is given by the derivative. Hence we must solve the equation $f'(x) = 0$.

$$0 = f'(x) = 1 + \ln(x) \implies x = e^{-1}$$

Hence the point on the graph with a horizontal tangent is $(e^{-1}, f(e^{-1})) = (e^{-1}, -e^{-1})$.**12 p**

- 78.**
- Find the values of
- a
- and
- b
- that make
- f
- continuous at
- $x = 1$
- or determine that no such values exist.

$$f(x) = \begin{cases} -3x + ax^2 & x < 1 \\ b & x = 1 \\ 4ax - 1 & x > 1 \end{cases}$$

In your work, you must use limit-based methods to solve this problem. Solutions that have work that is not based on limits will not receive full credit.

Solution

First we calculate the left-limit, right-limit, and function value at $x = 1$.

$$\begin{aligned}\lim_{x \rightarrow 1^-} f(x) &= \lim_{x \rightarrow 1^-} (-3x + ax^2) = -3 + a \\ \lim_{x \rightarrow 1^+} f(x) &= \lim_{x \rightarrow 1^+} (4ax - 1) = 4a - 1 \\ f(1) &= b\end{aligned}$$

For f to be continuous at $x = 1$, the left-limit, right-limit, and function value at $x = 1$ must all be equal. Hence we must have

$$-3 + a = 4a - 1 = b$$

Solving for a in $-3 + a = 4a - 1$ gives $a = -\frac{2}{3}$, and then solving for b in $4a - 1 = b$ gives $b = -\frac{11}{3}$.

Midterm Exam #2

20 p

79. For each part, calculate the limit or show that it does not exist. If the limit is “ $+\infty$ ” or “ $-\infty$ ”, write that as your answer, instead of “does not exist”.

(a) $\lim_{x \rightarrow \pi} \left(\frac{1 + \cos(x)}{(x - \pi)^2} \right)$

(c) $\lim_{x \rightarrow 1} \left(\frac{x^3 - 2x^2 - 5x + 6}{x^3 + x^2 + x - 3} \right)$

(b) $\lim_{x \rightarrow \infty} \left(1 - \frac{12}{x} \right)^{5x}$

(d) $\lim_{x \rightarrow 4^+} \left(\frac{2x - x^2}{x - 4} \right)$

Solution

(a) Direct substitution of $x = \pi$ gives $0/0$, and so we may use L'Hospital's Rule.

$$\lim_{x \rightarrow \pi} \left(\frac{1 + \cos(x)}{(x - \pi)^2} \right) \stackrel{H}{=} \lim_{x \rightarrow \pi} \left(\frac{-\sin(x)}{2(x - \pi)} \right)$$

Direct substitution of $x = \pi$ gives $0/0$ again, and so we may use L'Hospital's Rule again.

$$\lim_{x \rightarrow \pi} \left(\frac{-\sin(x)}{2(x - \pi)} \right) \stackrel{H}{=} \lim_{x \rightarrow \pi} \left(\frac{-\cos(x)}{2} \right) = \frac{-\cos(\pi)}{2} = \frac{1}{2}$$

(b) As $x \rightarrow \infty$, we find that we have the indeterminate form 1^∞ . So we use logarithms and L'Hospital's Rule. Let L be the desired limit and consider $\ln(L)$.

$$\ln(L) = \lim_{x \rightarrow \infty} \ln \left[\left(1 - \frac{12}{x} \right)^{5x} \right] = \lim_{x \rightarrow \infty} \left(5x \ln \left(1 - \frac{12}{x} \right) \right) = \lim_{x \rightarrow \infty} \left(\frac{5 \ln \left(1 - \frac{12}{x} \right)}{1/x} \right)$$

We now have the indeterminate form $0/0$, and so we may use L'Hospital's Rule.

$$\lim_{x \rightarrow \infty} \left(\frac{5 \ln \left(1 - \frac{12}{x} \right)}{1/x} \right) \stackrel{H}{=} \lim_{x \rightarrow \infty} \left(\frac{5 \cdot \frac{1}{1 - \frac{12}{x}} \cdot \frac{12}{x^2}}{-1/x^2} \right) = \lim_{x \rightarrow \infty} \left(\frac{-60}{1 - \frac{12}{x}} \right) = \frac{-60}{1 - 0} = -60$$

So we have $\ln(L) = -60$, whence $L = e^{-60}$.

(c) Direct substitution of $x = 1$ gives $0/0$, and so we may use L'Hospital's Rule.

$$\lim_{x \rightarrow 1} \left(\frac{x^3 - 2x^2 - 5x + 6}{x^3 + x^2 + x - 3} \right) \stackrel{H}{=} \lim_{x \rightarrow 1} \left(\frac{3x^2 - 4x - 5}{3x^2 + 2x + 1} \right) = \frac{3 - 4 - 5}{3 + 2 + 1} = -1$$

(d) Direct substitution of $x = 4$ gives $-8/0$, which is not an indeterminate form but rather tells us that the one-sided limit is infinite. Note that if $x \rightarrow 4^+$, then we may assume $x - 4 > 0$, whence the denominator has limit 0 but remains positive. The numerator has limit -8 , which is negative. So the sign of our limit is $\ominus/\oplus = \ominus$. So the limit is $-\infty$.

5 p

80. Find the x -coordinate of each inflection point, if any, of $f(x) = x^3 - 12x^2 + 5x - 10$.

Solution

Observe that $f''(x) = 6x - 24 = 6(x - 4)$, which changes sign (from negative to positive) at $x = 4$. Since f is also continuous at $x = 4$, f has an inflection point at $x = 4$.

- 5 p** 81. Find an equation of the line tangent to the following curve at the origin.

$$\sin(x + 2y) + 9x + 1 = e^y$$

Solution

Implicitly differentiating each side of the equation with respect to x gives the following.

$$\cos(x + 2y) \cdot \left(1 + 2 \frac{dy}{dx}\right) + 9 = e^y \cdot \frac{dy}{dx}$$

Substituting $x = y = 0$ gives us the equation:

$$1 + 2 \frac{dy}{dx} + 9 = \frac{dy}{dx}$$

Hence $\frac{dy}{dx} = -10$ at the point $(0, 0)$, and the desired tangent line is $y = -10x$.

- 5 p** 82. If x units of a certain product are produced, the total cost is $C(x) = 5x^2 + 104x + 80$. Find the level of production which minimizes the average cost per unit.

Solution

The average cost per unit is

$$AC(x) = \frac{C(x)}{x} = 5x + 104 + \frac{80}{x}$$

The minimum value of $AC(x)$ occurs at the value of x such that $AC'(x) = 0$. Observe that

$$AC'(x) = 5 - \frac{80}{x^2}$$

and $AC'(x) = 0$ has solutions $x = 4$ and $x = -4$. Since production must be non-negative, average cost is minimized when $x = 4$.

- 10 p** 83. A spherical snowball melts in such a way that it always remains a sphere, and its volume decreases at $8 \text{ cm}^3/\text{sec}$. At what rate is the surface area of the snowball changing when its surface area is $40\pi \text{ cm}^2$? *You must give correct units as part of your answer.*

Solution

The volume and surface area of the snowball are given by these equations:

$$V = \frac{4}{3}\pi r^3 \quad , \quad A = 4\pi r^2$$

Differentiating each equation with respect to t gives us two more equations.

$$\frac{dV}{dt} = 4\pi r^2 \frac{dr}{dt} \quad , \quad \frac{dA}{dt} = 8\pi r \frac{dr}{dt}$$

Now we substitute the given information. Specifically, $\frac{dV}{dt} = -8$ and $A = 40\pi$. The four equations above give us the following.

$$\begin{aligned} V &= \frac{4}{3}\pi r^3 & 40\pi &= 4\pi r^2 \\ -8 &= 4\pi r^2 \frac{dr}{dt} & \frac{dA}{dt} &= 8\pi r \frac{dr}{dt} \end{aligned}$$

Our goal is to solve for $\frac{dA}{dt}$. The upper right equation gives us $r = \sqrt{10}$ and substituting this into the lower left equation gives us $\frac{dr}{dt} = -\frac{8}{40\pi}$. So now substituting everything into the lower right equation gives the final answer.

$$\frac{dA}{dt} = 8\pi \cdot \sqrt{10} \cdot \frac{-8}{40\pi} = -\frac{8\sqrt{10}}{5}$$

So the surface area is changing at a rate of $-\frac{8\sqrt{10}}{5}$ cm²/sec.

84. Note: The parts of this problem are not related!

5 p

(a) Use linear approximation to estimate the value of $\sqrt{79}$.

5 p

(b) A manufacturer's total cost to produce x units is $C(x) = 25 \ln(x^2 + 16)$. Use marginal analysis to estimate the cost of the 4th unit.

Solution

(a) We use the tangent line to $f(x) = \sqrt{x}$ at $x = 81$. We have $f(81) = 9$ and $f'(x) = \frac{1}{2}x^{-1/2}$, whence $f'(81) = \frac{1}{18}$. Hence our tangent line is

$$y = 9 + \frac{1}{18}(x - 81)$$

Recall the fundamental principle of linear approximation. If x is near 81, then the y -values on the tangent line approximate the values of $f(x)$. So we have

$$\sqrt{79} \approx 9 + \frac{1}{18}(79 - 81) = 9 - \frac{1}{9} = \frac{80}{9}$$

(b) Marginal analysis tells us that the approximate cost of the 4th unit is $C'(3)$. So we have:

$$C'(3) = 25 \cdot \frac{2x}{x^2 + 16} \Big|_{x=3} = \frac{50 \cdot 3}{9 + 16} = \frac{150}{25} = 6$$

10 p

85. Suppose y is defined implicitly as a function of x by the following equation.

$$x^3 y^2 + (x + y)^2 = 100$$

Find $\frac{dy}{dx}$. Do not simplify your answer.

Solution

Implicitly differentiate each side of the equation, making sure to carefully use product rule and chain rule.

$$3x^2 \cdot y^2 + x^3 \cdot 2y \cdot \frac{dy}{dx} + 2(x + y) \cdot \left(1 + \frac{dy}{dx}\right) = 0$$

We now algebraically solve for $\frac{dy}{dx}$.

$$\frac{dy}{dx} = \frac{-(3x^2y^2 + 2(x + y))}{2x^3y + 2(x + y)}$$

10 p

86. A rectangular container with a closed top and a square base is to be constructed. The top and all four sides of the container are to be made of material that costs \$2/ft², and the bottom is to be made of material that costs \$3/ft². Find the container with the largest volume that can be constructed for a total cost of \$60.

You must use calculus-based methods in your work. You must also justify that your answer really does give the maximum.

Solution

Let x be the length of the square base and let y be the height of the container. The constraint is that the total cost of the box must be \$60, and so our constraint equation in terms of x and y is:

$$2(x^2 + 4xy) + 3x^2 = 60$$

Solving for y gives us

$$y = \frac{60 - 5x^2}{8x}$$

Our goal is to maximize the volume, whence our objective function is $V(x, y) = x^2y$. In terms of x only, our objective is:

$$f(x) = V\left(x, \frac{60 - 5x^2}{8x}\right) = x^2 \cdot \frac{60 - 5x^2}{8x} = \frac{1}{8}(60x - 5x^3)$$

To maximize f , we find the critical points of f , which are solutions to $f'(x) = 0$.

$$f'(x) = \frac{1}{8}(60 - 15x^2) = \frac{15}{8}(4 - x^2)$$

Hence the only valid solution to $f'(x) = 0$ is $x = 2$. (We reject $x = -2$ since lengths must be non-negative.)

Now observe that $f''(x) = -\frac{30}{8}x$, which is negative for all $x > 0$. Hence our objective function has one critical point and is always concave down. So our critical point must give a global maximum value.

The length of the box is $x = 2$, the height is $y = 2.5$, and the volume is $f(2) = 10$.

25 p

87. Consider the function f and its derivatives below.

$$f(x) = \frac{3x^3 - 2x + 48}{x}, \quad f'(x) = \frac{6(x^3 - 8)}{x^2}, \quad f''(x) = \frac{6(x^3 + 16)}{x^3}$$

Fill in the table below with information about the graph of $y = f(x)$. For each part, write "NONE" as your answer if appropriate. Where applicable, give a comma-separated list of intervals that are as inclusive as possible.

You do not have to show work, and each table item will be graded with no partial credit.

Solution

equation(s) of vertical asymptote(s) of f	$x = 0$
equation(s) of horizontal asymptote(s) of f	NONE
where f is decreasing	$(-\infty, 0), (0, 2]$
where f is increasing	$[2, \infty)$
x -coordinate(s) of local minima of f	$x = 2$
x -coordinate(s) of local maxima of f	NONE
where f is concave down	$[-\sqrt[3]{16}, 0)$
where f is concave up	$(-\infty, -\sqrt[3]{16}], (0, \infty)$
x -coordinate(s) of inflection point(s) of f	$x = -\sqrt[3]{16}$

The derivatives of f are

$$f(x) = \frac{3x^3 - 2x + 48}{x}, \quad f'(x) = \frac{6(x^3 - 8)}{x^2}, \quad f''(x) = \frac{6(x^3 + 16)}{x^3}$$

(i) *Vertical asymptotes and horizontal asymptotes.*

Observe that f is continuous on its domain, but is undefined for $x = 0$. Hence our candidate vertical asymptotes is the line $x = 0$. Indeed, direct substitution of $x = 0$ into $f(x)$ gives the expression " $\frac{48}{0}$ ", which indicates that both one-sided limits are infinite. Hence the line $x = 0$ is a true vertical asymptote.

As for the horizontal asymptotes we have the following.

$$\lim_{x \pm \infty} f(x) = \lim_{x \pm \infty} \left(3x^2 - 2 + \frac{48}{x} \right) = \infty - 2 + 0 = \infty$$

Hence there are no horizontal asymptotes.

(ii) *Intervals of increase and local extrema.*

We calculate a sign chart for the first derivative. The cut points are the solutions to $f'(x) = 0$ ($x = 2$) and the vertical asymptotes ($x = 0$).

interval	test point	sign of f'	shape of f
$(-\infty, 0)$	$f'(-1)$	$\frac{6\ominus}{\oplus} = \ominus$	decreasing
$(0, 2)$	$f'(1)$	$\frac{6\ominus}{\oplus} = \ominus$	decreasing
$(2, \infty)$	$f'(3)$	$\frac{6\oplus}{\oplus} = \oplus$	increasing

Hence we deduce the following about f :

f is decreasing on: $(-\infty, 0), (0, 2]$
 f is increasing on: $[2, \infty)$
 f has a local min at: $x = 2$
 f has a local max at: *none*

(iii) *Intervals of concavity and inflection points.*

We calculate a sign chart for the second derivative: The cut points are the solutions to $f''(x) = 0$ ($x = -\sqrt[3]{16}$) and the vertical asymptotes ($x = 0$).

interval	test point	sign of f''	shape of f
$(-\infty, -\sqrt[3]{16})$	$f''(-3)$	$\frac{6\ominus}{\ominus} = \oplus$	concave up
$(-\sqrt[3]{16}, 0)$	$f''(-1)$	$\frac{6\oplus}{\ominus} = \ominus$	concave down
$(0, \infty)$	$f''(1)$	$\frac{6\oplus}{\oplus} = \oplus$	concave up

Hence we deduce the following about f :

f is concave down on: $[-\sqrt[3]{16}, 0)$
 f is concave up on: $(-\infty, -\sqrt[3]{16}], (0, \infty)$
 f has an infl. point at: $x = -\sqrt[3]{16}$

(iv) *Sketch of graph.*

Not required.

1.6 Spring 2020

Midterm Exam #1

5 p

88. Solve the inequality $\frac{3x+6}{x-4} < 0$. Write your answer using interval notation.

Solution

We solve the inequality using the method of sign charts. The cut points for our number line are $x = -2$ (obtained by solving $3x + 6 = 0$) and $x = 4$ (obtained by solving $x - 4 = 0$).

interval	test point	sign of $\frac{3x+6}{x-4}$	truth of inequality
$(-\infty, -2)$	$x = -3$	$\ominus = \oplus$	false
$(-2, 4)$	$x = 0$	$\oplus = \ominus$	true
$(4, \infty)$	$x = 5$	$\oplus = \oplus$	false

The inequality is not satisfied at either cut point $x = -2$ or $x = 4$. Hence the solution to our inequality is the set $(-2, 4)$.

5 p

89. Find the domain of the function $f(x) = \frac{\ln(80-x)}{\sqrt{x}-5}$. Write your answer using interval notation.

Solution

The expression $\ln(80-x)$ is defined only for $80-x > 0$, or on the interval $(-\infty, 80)$. The expression \sqrt{x} is defined only for $x \geq 0$, or on the interval $[0, \infty)$. Both expressions are thus defined on the intersection of these two intervals: $[0, 80)$. Finally, we must exclude any values of x for which $\sqrt{x} - 5 = 0$, so just $x = 25$. Hence the domain of f is $[0, 25) \cup (25, 80)$.

30 p

90. For each part, calculate the limit or show that it does not exist. If the limit is “ $+\infty$ ” or “ $-\infty$ ”, write that as your answer, instead of “does not exist”.

(a) $\lim_{x \rightarrow 0} \left(\frac{(4x+1)^2 - 1}{x} \right)$

(d) $\lim_{x \rightarrow 4^-} \left(\frac{|x^2 - 16|}{4-x} \right)$

(b) $\lim_{x \rightarrow 0} \left(\frac{9x \cos(2x)}{\sin(4x)} \right)$

(e) $\lim_{x \rightarrow 3} g(x)$, where $g(x) = \begin{cases} \frac{x-3}{x^3-9x} & x < 3 \\ 18 & x = 3 \\ \frac{x-2}{x^2+9} & x > 3 \end{cases}$

(c) $\lim_{x \rightarrow -1} \left(\frac{4 - \sqrt{16x+32}}{x+1} \right)$

Solution

- (a) Expand and cancel common factors.

$$\lim_{x \rightarrow 0} \left(\frac{(4x+1)^2 - 1}{x} \right) = \lim_{x \rightarrow 0} \left(\frac{16x^2 + 8x + 1 - 1}{x} \right) = \lim_{x \rightarrow 0} (16x + 8) = 8$$

- (b) Rearrange the terms and use the special trigonometric limit and direct substitution.

$$\lim_{x \rightarrow 0} \left(\frac{9x \cos(2x)}{\sin(4x)} \right) = \lim_{x \rightarrow 0} \left(\frac{4x}{\sin(4x)} \cdot \frac{9}{4} \cdot \cos(2x) \right) = 1 \cdot \frac{9}{4} \cdot 1 = \frac{9}{4}$$

(c) Rationalize the numerator and cancel common factors.

$$\begin{aligned}\lim_{x \rightarrow -1} \left(\frac{4 - \sqrt{16x + 32}}{x + 1} \right) &= \lim_{x \rightarrow -1} \left(\frac{16 - (16x + 32)}{(x + 1)(4 + \sqrt{16x + 32})} \right) \\ &= \lim_{x \rightarrow -1} \left(\frac{-16}{4 + \sqrt{16x + 32}} \right) = \frac{-16}{4 + 4} = -2\end{aligned}$$

(d) Note that the limit symbol “ $x \rightarrow 4^-$ ” means that we may assume that both x is arbitrarily close to 4 and $x < 4$. For values of x just slightly less than 4, the values of $x^2 - 16$ are negative. Hence under the assumptions of this limit, we have $|x^2 - 16| = -(x^2 - 16) = 16 - x^2 = (4 - x)(4 + x)$. So now we have

$$\lim_{x \rightarrow 4^-} \left(\frac{|x^2 - 16|}{4 - x} \right) = \lim_{x \rightarrow 4^-} \left(\frac{(4 - x)(4 + x)}{4 - x} \right) = \lim_{x \rightarrow 4^-} (4 + x) = 8$$

(e) Compute the left- and right-limits and verify whether they are equal. For the left-limit cancel common factors. For the right-limit, use direct substitution. The function value $g(3)$ is irrelevant to this problem.

$$\begin{aligned}\lim_{x \rightarrow 3^-} g(x) &= \lim_{x \rightarrow 3^-} \left(\frac{x - 3}{x^3 - 9x} \right) = \lim_{x \rightarrow 3^-} \left(\frac{1}{x(x + 3)} \right) = \frac{1}{18} \\ \lim_{x \rightarrow 3^+} g(x) &= \lim_{x \rightarrow 3^+} \left(\frac{x - 2}{x^2 + 9} \right) = \frac{1}{18}\end{aligned}$$

The left- and right-limits are both equal to $\frac{1}{18}$, hence $\lim_{x \rightarrow 3} g(x) = \frac{1}{18}$ also.

5 p

91. Determine where f is continuous. Write your answer using interval notation.

$$f(x) = \begin{cases} 9 - 16x & x < 0 \\ 3x^2 - x^3 & 0 \leq x \leq 3 \\ 1 - e^{x-3} & x > 3 \end{cases}$$

Solution

Observe that f is clearly continuous for all x except possibly $x = 0$ or $x = 3$. For these transition points, we check whether the corresponding left-limit, right-limit, and function value are equal. For $x = 0$ we have:

$$\begin{aligned}\lim_{x \rightarrow 0^-} f(x) &= \lim_{x \rightarrow 0^-} (9 - 16x) = 9 - 0 = 9 \\ \lim_{x \rightarrow 0^+} f(x) &= \lim_{x \rightarrow 0^+} (3x^2 - x^3) = 0 - 0 = 0 \\ f(0) &= (3x^2 - x^3)|_{x=0} = 0\end{aligned}$$

Since these three values are not all equal, f is discontinuous at $x = 0$. For $x = 3$ we have:

$$\begin{aligned}\lim_{x \rightarrow 3^-} f(x) &= \lim_{x \rightarrow 3^-} (3x^2 - x^3) = 27 - 27 = 0 \\ \lim_{x \rightarrow 3^+} f(x) &= \lim_{x \rightarrow 3^+} (1 - e^{x-3}) = 1 - 1 = 0 \\ f(3) &= (3x^2 - x^3)|_{x=3} = 27 - 27 = 0\end{aligned}$$

Since these three values are all equal, f is continuous at $x = 3$. Hence the final answer is that f is continuous on $(-\infty, 0) \cup (0, \infty)$.

5 p

92. Find an equation of the line tangent to the graph of $f(x) = 5e^{2\cos(x)}$ at $x = 3\pi/2$.

Solution

The point of tangency is $(\frac{3\pi}{2}, f(\frac{3\pi}{2})) = (\frac{3\pi}{2}, 5)$. Observe that $f'(x) = 5e^{2\cos(x)} \cdot (-2\sin(x))$. Hence the slope of the tangent line is $f'(\frac{3\pi}{2}) = 10$. Thus an equation of the tangent line is

$$y - 5 = 10 \left(x - \frac{3\pi}{2} \right)$$

20 p

93. For each part, calculate $f'(x)$. *Do not simplify your answers.*

(a) $f(x) = 2x^2 - \frac{1}{5x} - 8\sqrt{x} + 14\pi^{3/2}$

(c) $f(x) = \sin(12x - x^9) \ln(x)$

(b) $f(x) = \left(\frac{x^4 - 20x}{x^3 + 20} \right)^{2/3}$

(d) $f(x) = \frac{e^{5\sec(6x)+1}}{7}$

Solution

(a) Write the function using exponents.

$$f(x) = 2x^2 - \frac{1}{5}x^{-1} - 8x^{1/2} + 14\pi^{3/2}$$

Differentiate using power rule, noting that $14\pi^{3/2}$ is a constant.

$$f'(x) = 4x - \frac{1}{5}x^{-2} - 4x^{-1/2}$$

(b) Use power rule first, then use chain rule (using quotient rule to find the derivative of the “inside” function).

$$f'(x) = \frac{2}{3} \left(\frac{x^4 - 20x}{x^3 + 20} \right)^{-1/3} \cdot \frac{(4x^3 - 20)(x^3 + 20) - (x^4 + 20x)(3x^2)}{(x^3 + 20)^2}$$

(c) Use product rule. When differentiating the first term, use chain rule.

$$f'(x) = \cos(12x - x^9) \cdot (12 - 9x^8) \cdot \ln(x) + \sin(12x - x^9) \cdot \frac{1}{x}$$

(d) Use chain rule twice. (Do not use quotient rule. The factor of $\frac{1}{7}$ is a constant coefficient.)

$$f'(x) = \frac{1}{7} e^{5\sec(6x)+1} \cdot 5\sec(6x) \tan(6x) \cdot 6$$

10 p

94. Let $f(x) = \frac{x+8}{x-3}$. Use the limit definition of derivative to calculate $f'(2)$. *If you simply quote a rule, you will receive no credit. You must use the definition of derivative.*

Solution

Start with the definition of derivative and compute the limit using algebra.

$$\begin{aligned} f'(2) &= \lim_{h \rightarrow 0} \left(\frac{f(2+h) - f(2)}{h} \right) = \lim_{h \rightarrow 0} \left(\frac{\frac{h+10}{h-1} - (-10)}{h} \right) = \lim_{h \rightarrow 0} \left(\frac{h+10+10(h-1)}{h(h-1)} \right) \\ &= \lim_{h \rightarrow 0} \left(\frac{11h}{h(h-1)} \right) = \lim_{h \rightarrow 0} \left(\frac{11}{h-1} \right) = \frac{11}{0-1} = -11 \end{aligned}$$

10 p

95. Find the x -coordinate of each point on the graph of $f(x) = 3x + \frac{10}{x}$ where the tangent line is parallel to the line $y = 20 - 2x$.

Solution

The slope of the line $y = 20 - 2x$ is -2 and parallel lines have equal slopes. Hence we seek all values of x that solve the equation $f'(x) = -2$.

$$f'(x) = -2 \implies 3 - \frac{10}{x^2} = -2$$

Solving for x gives $x = -\sqrt{2}$ or $x = \sqrt{2}$.

10 p

96. Find the value of k that makes f continuous at $x = -2$ or determine that no such value of k exists.

$$f(x) = \begin{cases} 3x^2 + k & x < -2 \\ -10 & x = -2 \\ kx^3 - 6 & x > -2 \end{cases}$$

In your work, you must use limit-based methods to solve this problem. Solutions that have work that is not based on limits will not receive full credit.

Solution

For f to be continuous at $x = -2$, the corresponding left-limit, right-limit, and function value must all be equal. Those three values in terms of k are given by the following:

$$\begin{aligned} \lim_{x \rightarrow -2^-} f(x) &= \lim_{x \rightarrow -2^-} (3x^2 + k) = 12 + k \\ \lim_{x \rightarrow -2^+} f(x) &= \lim_{x \rightarrow -2^+} (kx^3 - 6) = -8k - 6 \\ f(-2) &= -10 \end{aligned}$$

If f is to be continuous at $x = -2$, we must have $12 + k = -8k - 6 = -10$. This is equivalent to the following set of two equations in the single unknown k .

$$\begin{aligned} 12 + k &= -10 \\ -8k - 6 &= -10 \end{aligned}$$

This set of equations has no solution. (Indeed, the first equation gives $k = -22$, which does not satisfy the second equation.) Hence there is no value of k that makes f continuous at $x = -2$.

Midterm Exam #2A

10 p

97. Calculate the limit or show that it does not exist. If the limit is “ $+\infty$ ” or “ $-\infty$ ”, write that as your answer, instead of “does not exist”.

$$\lim_{x \rightarrow 0^+} (\sqrt{12x+9} - \sqrt{2x+4})^{1/x}$$

Solution

Direct substitution of $x = 0$ gives the indeterminate form 1^∞ . So we use logarithms to write the limit as a quotient, and we use L'Hospital's Rule.

$$\begin{aligned} L &= \lim_{x \rightarrow 0^+} (\sqrt{12x+9} - \sqrt{2x+4})^{1/x} \\ \ln(L) &= \lim_{x \rightarrow 0^+} \ln \left((\sqrt{12x+9} - \sqrt{2x+4})^{1/x} \right) \\ \ln(L) &= \lim_{x \rightarrow 0^+} \frac{\ln(\sqrt{12x+9} - \sqrt{2x+4})}{x} \\ \ln(L) &\stackrel{H}{=} \lim_{x \rightarrow 0^+} \frac{\frac{1}{\sqrt{12x+9} - \sqrt{2x+4}} \cdot \left(\frac{6}{\sqrt{12x+9}} - \frac{1}{\sqrt{2x+4}} \right)}{1} \\ \ln(L) &= \frac{\frac{1}{1} \cdot \left(\frac{6}{3} - \frac{1}{2} \right)}{1} = \frac{3}{2} \end{aligned}$$

So $\ln(L) = 3/2$, whence $L = e^{3/2}$.

10 p

98. A particle in the fourth quadrant is moving along a path described by the equation

$$x^2 + xy + 2y^2 = 16$$

such that at the moment its x -coordinate is 2, its y -coordinate is decreasing at a rate of 5 cm/sec. At what rate is its x -coordinate changing at that time?

Solution

Differentiating the given equation gives the following.

$$2x \frac{dx}{dt} + \frac{dx}{dt}y + x \frac{dy}{dt} + 4y \frac{dy}{dt} = 0$$

At the given time, we have $x = 2$ and $\frac{dy}{dt} = -5$, and we want to find $\frac{dx}{dt}$. Substituting this information into our two equations gives

$$\begin{aligned} 4 + 2y + 2y^2 &= 16 \\ 4 \frac{dx}{dt} + \frac{dx}{dt}y - 10 - 20y &= 0 \end{aligned}$$

Solving for y in the first equation gives $y = -3$ or $y = 2$. Since the particle is in the fourth quadrant, we have $y = -3$. Substituting into the second equation above gives

$$4 \frac{dx}{dt} - 3 \frac{dx}{dt} - 10 + 60 = 0$$

Hence $\frac{dx}{dt} = -50$ cm/sec.

- 10 p** 99. Use linear approximation or differentials to estimate the value of $\frac{1}{\sqrt[3]{8.48}}$.

Solution

Put $f(x) = x^{-1/3}$. We use the tangent line to f at $x = 8$. Observe that $f(8) = \frac{1}{2}$ and $f'(x) = -\frac{1}{3}x^{-4/3}$, whence $f'(8) = -\frac{1}{48}$. Hence the desired tangent line is

$$y = \frac{1}{2} - \frac{1}{48}(x - 8)$$

The desired approximation is then

$$(8.48)^{-1/3} \approx \frac{1}{2} - \frac{1}{48}(8.48 - 8) = \frac{1}{2} - \frac{1}{100} = 0.5 - 0.01 = 0.49$$

- 10 p** 100. Find an equation of line tangent to the following curve at the origin.

$$\sin(x + 3y) + 9x + 1 = e^y$$

Solution

Using implicit differentiation with respect to x gives the following.

$$\cos(x + 3y) \cdot \left(1 + 3\frac{dy}{dx}\right) + 9 = e^y \cdot \frac{dy}{dx}$$

Substituting $x = 0$ and $y = 0$ gives

$$1 + 3\frac{dy}{dx} + 9 = \frac{dy}{dx}$$

Hence the slope of the tangent line is $\frac{dy}{dx} = -5$, whence an equation of the tangent line is

$$y = -5x$$

- 10 p** 101. Find all horizontal asymptotes of

$$f(x) = \frac{12x + 5}{\sqrt{16x^2 + x + 1}}$$

or determine that there are no horizontal asymptotes.

Solution

First we do some algebra before computing the relevant limits.

$$\frac{12x + 5}{\sqrt{16x^2 + x + 1}} = \frac{x}{\sqrt{x^2}} \cdot \frac{12 + \frac{5}{x}}{\sqrt{16 + \frac{1}{x} + \frac{1}{x^2}}} = \frac{x}{|x|} \cdot \frac{12 + \frac{5}{x}}{\sqrt{16 + \frac{1}{x} + \frac{1}{x^2}}}$$

For the limit $x \rightarrow \infty$, we have $|x| = x$, whence $\frac{|x|}{x} = 1$. For the limit $x \rightarrow -\infty$, we have $|x| = -x$, whence $\frac{|x|}{x} = -1$. So now we have the following.

$$\lim_{x \rightarrow \infty} f(x) = \lim_{x \rightarrow \infty} \left(\frac{12 + \frac{5}{x}}{\sqrt{16 + \frac{1}{x} + \frac{1}{x^2}}} \right) = \frac{12 + 0}{\sqrt{16 + 0 + 0}} = 3$$

$$\lim_{x \rightarrow -\infty} f(x) = \lim_{x \rightarrow \infty} \left(-\frac{12 + \frac{5}{x}}{\sqrt{16 + \frac{1}{x} + \frac{1}{x^2}}} \right) = -\frac{12 + 0}{\sqrt{16 + 0 + 0}} = -3$$

Hence the horizontal asymptotes of f are $y = 3$ and $y = -3$.

- 4 p** 102. Suppose you want to compute a limit that is in the form of a quotient, i.e., a limit of the form:

$$\lim_{x \rightarrow a} \left(\frac{f(x)}{g(x)} \right)$$

Suppose you have already determined that L'Hospital's Rule is applicable. Explain the next step in your calculation, i.e., how do you apply L'Hospital's Rule? *Your answer may contain either English, mathematical symbols, or both.*

Solution

Compute the limit $\lim_{x \rightarrow a} \frac{f'(x)}{g'(x)}$.

- 4 p** 103. Consider the following function, where a and b are unspecified constants.

$$f(x) = \frac{x^2 + ax + b}{x - 2}$$

Is the line $x = 2$ necessarily a vertical asymptote of $f(x)$? Explain your answer. *Your answer may contain either English, mathematical symbols, or both.*

Solution

No. If $x - 2$ is also a factor of the numerator $x^2 + ax + b$ (i.e., if substitution of $x = 2$ into the numerator gives 0), then the limit $\lim_{x \rightarrow 2} f(x)$ would not be infinite, and so $x = 2$ would not be a vertical asymptote.

- 8 p** 104. A 6-ft tall person is initially standing 12 ft from point P directly beneath a lantern hanging 42 ft above the ground, as shown in the diagram below. The person then begins to walk towards point P at 5 ft/sec. Let D denote the distance between the person's feet and the point P . Let S denote the length of the person's shadow.

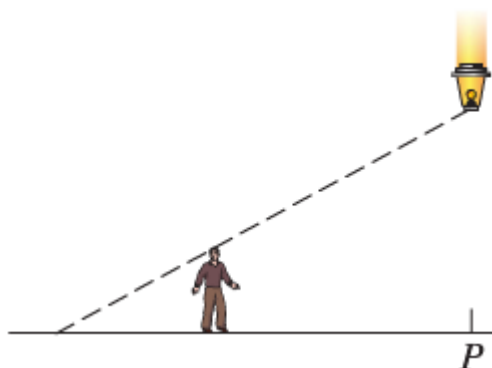

- (a) Write an equation that relates D and S .
- (b) Write an equation that expresses the English sentence “*The person then begins to walk towards point P at 5 ft/sec.*”
- (c) Is the length of the person’s shadow increasing, decreasing or remaining constant?
- (d) At what rate is the length of the person’s shadow changing when the person is 8 ft from point P ? Include correct units as part of your answer.

Solution

- (a) Use similar triangles to obtain $\frac{D+S}{S} = \frac{42}{6}$. (We may simplify this to $D = 6S$.)
- (b) $\frac{dD}{dt} = -5$. (The equation $D = 12 - 5t$ is also acceptable.)
- (c) The length of the shadow is decreasing.
- (d) The equation $D = 6S$ gives $\frac{dD}{dt} = 6\frac{dS}{dt}$ and we have $\frac{dD}{dt} = -5$, whence $\frac{dS}{dt} = -\frac{5}{6}$ ft/sec.

10 p

105. Consider the curve described by the equation

$$3x^2 + 2xy + 4y^2 = 132$$

At any point on this curve, we have

$$\frac{dy}{dx} = \frac{-3x - y}{x + 4y}$$

- (a) Describe in two or three sentences the steps you should take to find the points on the curve where the tangent line is horizontal. *Your answer may contain either English, mathematical symbols, or both.*
- (b) What is the rightmost (i.e., greatest x -coordinate) point on the curve where the tangent line is horizontal?
- (c) Describe in one or two sentences how parts (a) and (b) would change if instead you wanted to find the points where the tangent line is vertical. You do not have to solve the problem again, but only describe generally what you would do differently. *Your answer may contain either English, mathematical symbols, or both.*

Solution

- (a) The point must lie on the curve and the tangent line is horizontal (i.e., $\frac{dy}{dx} = 0$). So we must solve the following simultaneous set of equations for x and y .

$$\begin{aligned} 3x^2 + 2xy + 4y^2 &= 132 \\ \frac{-3x - y}{x + 4y} &= 0 \end{aligned}$$

(Note that the second equation is equivalent to $y = -3x$.)

- (b) Substituting $y = -3x$ into the original equation gives $3x^2 - 6x^2 + 36x^2 = 132$, or $33x^2 = 132$. Hence $x = -2$ or $x = 2$. The x -coordinate of the rightmost point with a horizontal tangent is thus $x = 2$. Since we also have $y = -3x$, the y -coordinate is $y = -6$.
- (c) A vertical tangent line has an undefined slope, so we replace the equation $\frac{dy}{dx} = 0$ with “denominator of $\frac{dy}{dx}$ is 0”. That is, we must solve the following simultaneous set of equations:

$$\begin{aligned} 3x^2 + 2xy + 4y^2 &= 132 \\ x + 4y &= 0 \end{aligned}$$

5 p

106. Each of the following limits is written in the form of a quotient. Which limits can be calculated using L'Hospital's Rule directly, i.e., by applying L'Hospital's Rule as the immediately next step without any other algebra or modification? Select all that apply.

$$\begin{array}{lll} \text{(a)} \lim_{x \rightarrow \pi} \left(\frac{\sin(7x)}{x} \right) & \text{(c)} \lim_{x \rightarrow \infty} \left(\frac{x^{-1} + 5}{x^{-2} + 8} \right) & \text{(e)} \lim_{x \rightarrow \infty} \left(\frac{e^x + 10}{e^x - 3} \right) \\ \text{(b)} \lim_{x \rightarrow 2} \left(\frac{x^3 + 3x - 14}{x^2 - 5x + 6} \right) & \text{(d)} \lim_{x \rightarrow 9^-} \left(\frac{x^{3/2} + x - 36}{x - \sqrt{x} - 6} \right) & \text{(f)} \lim_{x \rightarrow -\infty} \left(\frac{e^x + 10}{e^x - 3} \right) \end{array}$$

Solution

The only indeterminate quotients (for which L'Hospital's Rule is directly applicable) are $\frac{0}{0}$ and $\frac{\infty}{\infty}$. Hence the only limits above that can be computed with L'Hospital's Rule are: (b), (d), and (e).

5 p

107. Which of the following limits are equal to $+\infty$? Select all that apply.

$$\begin{array}{lll} \text{(a)} \lim_{x \rightarrow 5^-} \left(\frac{x^2 + 25}{5 - x} \right) & \text{(c)} \lim_{x \rightarrow -3^-} \left(\frac{x^3}{|x + 3|} \right) & \text{(e)} \lim_{x \rightarrow 1^+} \left(\frac{x^6 - x^2}{x - 1} \right) \\ \text{(b)} \lim_{x \rightarrow 5^+} \left(\frac{x^2 + 25}{5 - x} \right) & \text{(d)} \lim_{x \rightarrow 0^-} \left(\frac{x^4 - 2x - 5}{\sin(x)} \right) & \end{array}$$

Solution

Direct substitution of each x -value gives $\frac{\text{non-zero} \neq}{0}$ only for (a) - (d). A sign analysis of numerator and denominator then shows that only (a) and (d) are equal to $+\infty$. As for (e), we apply L'Hospital's Rule and find

$$\lim_{x \rightarrow 1^+} \left(\frac{x^6 - x^2}{x - 1} \right) \stackrel{H}{=} \lim_{x \rightarrow 1^+} \left(\frac{6x^5 - 2x}{1} \right) = 4$$

Hence only (a) and (d) are correct choices.

- 4 p** 108. Each of the following statements describes a scenario in which a certain rectangle is changing over time. For each part, mark “T” if the statement is true or mark “F” if the statement is false. You do not have to explain your answers or show any work.
- (a) T F If two opposite sides of the rectangle increase in length and if the area remains constant, then the other two opposite sides must decrease in length.
- (b) T F If the area of the rectangle increases, then all sides of the rectangle must also increase in length.
- (c) T F If the length of the rectangle remains the same, then the area and the width of the rectangle cannot change in opposite ways (i.e., one cannot increase while the other decreases).
- (d) T F If two opposite sides of the rectangle increase in length and the other two opposite sides decrease in length, then the area of the rectangle must remain constant.

Solution

This problem can be answered by physical considerations alone. We may also use the equation $A = LW$, from which it follows:

$$\frac{dA}{dt} = \frac{dL}{dt}W + L\frac{dW}{dt}$$

Note that L and W must be positive numbers since they are lengths.

- (a) **True.** If $\frac{dL}{dt} > 0$ and $\frac{dA}{dt} = 0$, then $\frac{dW}{dt} = -\frac{W}{L}\frac{dL}{dt} < 0$.
- (b) **False.** If $\frac{dA}{dt} > 0$, it is possible for at least one of $\frac{dL}{dt}$ and $\frac{dW}{dt}$ to be negative. For instance, consider a rectangle with $L = W = 1$, $\frac{dL}{dt} = 2$, and $\frac{dW}{dt} = -1$.
- (c) **True.** If $\frac{dL}{dt} = 0$, then we must have $\frac{dA}{dt} = L\frac{dW}{dt}$. Since $L > 0$, we see that $\frac{dA}{dt}$ and $\frac{dW}{dt}$ must have the same sign.
- (d) **False.** If $\frac{dL}{dt} > 0$ and $\frac{dW}{dt} < 0$, it is possible to have $\frac{dA}{dt} \neq 0$. See part (b) for an example.

- 10 p** 109. Suppose the cost of manufacturing x units is given by $C(x) = x^3 + 5x^2 + 12x + 50$.

- (a) What is the exact cost of producing the 3rd unit?
- (b) Using marginal analysis, estimate the cost of producing the 3rd unit.

Solution

- (a) $C(3) - C(2) = 56$
- (b) $C'(2) = (3x^2 + 10x + 12)|_{x=2} = 44$

Midterm Exam #2B

- 10 p** 110. Calculate the limit or show that it does not exist. If the limit is “ $+\infty$ ” or “ $-\infty$ ”, write that as your answer, instead of “does not exist”.

$$\lim_{x \rightarrow \infty} (5x^3 + 2x^2 + 8)^{1/\ln(x)}$$

Solution

Direct substitution of “ $x \rightarrow \infty$ ” gives the indeterminate form ∞^0 . So we use logarithms to write the limit as a quotient, and we use L’Hospital’s Rule.

$$\begin{aligned} L &= \lim_{x \rightarrow \infty} (5x^3 + 2x^2 + 8)^{1/\ln(x)} \\ \ln(L) &= \lim_{x \rightarrow \infty} \ln \left((5x^3 + 2x^2 + 8)^{1/\ln(x)} \right) \\ \ln(L) &= \lim_{x \rightarrow \infty} \left(\frac{\ln(5x^3 + 2x^2 + 8)}{\ln(x)} \right) \\ \ln(L) &\stackrel{H}{=} \lim_{x \rightarrow \infty} \left(\frac{\frac{1}{5x^3 + 2x^2 + 8} \cdot (15x^2 + 4x)}{\frac{1}{x}} \right) \\ \ln(L) &= \lim_{x \rightarrow \infty} \left(\frac{15x^3 + 4x^2}{5x^3 + 2x^2 + 8} \right) \\ \ln(L) &= \lim_{x \rightarrow \infty} \left(\frac{15 + \frac{4}{x}}{5 + \frac{2}{x} + \frac{8}{x^3}} \right) = \frac{15 + 0 + 0}{5 + 0 + 0} = 3 \end{aligned}$$

So $\ln(L) = 3$, whence $L = e^3$.

- 10 p** 111. The volume of a cube is decreasing at the rate of $300 \text{ cm}^3/\text{sec}$ at the moment its total surface area is 150 cm^2 . What is the rate of change of the length of one edge of the cube at this moment?

Solution

Let x , S , and V be the edge length, total surface area, and volume, respectively. Then $V = x^3$ and $S = 6x^2$. Differentiating these equations gives

$$\frac{dV}{dt} = 3x^2 \frac{dx}{dt} \quad , \quad \frac{dS}{dt} = 12x \frac{dx}{dt}$$

At the moment described, we have $\frac{dV}{dt} = -300$ and $S = 150$, and we seek $\frac{dx}{dt}$. Substituting this information into our four equations gives the following.

$$V = x^3 \quad , \quad 150 = 6x^2 \quad , \quad -300 = 3x^2 \frac{dx}{dt} \quad , \quad \frac{dS}{dt} = 12x \frac{dx}{dt}$$

The second equation gives $x = 5$. Putting $x = 5$ into the third equation gives $\frac{dx}{dt} = -4 \text{ cm/sec}$.

- 10 p** 112. Use linear approximation to estimate the value of $(0.98)^3 - 5(0.98)^2 + 4(0.98) + 10$.

Solution

Put $f(x) = x^3 - 5x^2 + 4x + 10$. We use the tangent line to f at $x = 1$. Observe that $f(1) = 10$ and $f'(x) = 3x^2 - 10x + 5$, whence $f'(1) = -2$. Hence the desired tangent line is

$$y = 10 - 2(x - 1)$$

The desired approximation is then

$$(0.98)^3 - 5(0.98)^2 + 4(0.98) + 10 \approx 10 - 2(0.98 - 1) = 10.04$$

10 p 113. Find an equation of the line tangent to the following curve at $(1, 7)$.

$$\ln(xy + x - 7) = 2x + 4y - 30$$

Solution

Using implicit differentiation with respect to x gives the following.

$$\frac{1}{xy + x - 7} \cdot \left(x \frac{dy}{dx} + y + 1 \right) = 2 + 4 \frac{dy}{dx}$$

Substituting $x = 1$ and $y = 7$ gives

$$\frac{dy}{dx} + 8 = 2 + 4 \frac{dy}{dx}$$

Hence the slope of the tangent line is $\frac{dy}{dx} = 2$, whence an equation of the tangent line is

$$y = 7 + 2(x - 1)$$

10 p 114. Consider the function below.

$$f(x) = \frac{x^3 + 2x^2 - 13x + 10}{x^2 - 1}$$

Show that $x = -1$ is a vertical asymptote of f , but $x = 1$ is *not* a vertical asymptote of f .

Solution

For $x = -1$, direct substitution gives the form " $\frac{24}{0}$ ", i.e., a nonzero divided by 0. Hence both one-sided limits of f at $x = -1$ are infinite, and so $x = -1$ is a vertical asymptote.

For $x = 1$, direct substitution gives the indeterminate form $\frac{0}{0}$, which *may* indicate a vertical asymptote but not necessarily. So we use L'Hospital's Rule.

$$\lim_{x \rightarrow 1} f(x) = \lim_{x \rightarrow 1} \left(\frac{x^3 + 2x^2 - 13x + 10}{x^2 - 1} \right) \stackrel{H}{=} \lim_{x \rightarrow 1} \left(\frac{3x^2 + 4x - 13}{2x} \right) = \frac{-6}{2} = -3$$

Since this limit is not infinite, $x = 1$ is not a vertical asymptote.

- 5 p** 115. Suppose you have determined

$$\lim_{x \rightarrow a} f(x) = 0 \quad , \quad \lim_{x \rightarrow a} g(x) = \infty$$

and you want to calculate the following limit:

$$L = \lim_{x \rightarrow a} (f(x)g(x))$$

You recall that to calculate L , you have to use L'Hospital's Rule. What is the next step you must take before you are able to apply L'Hospital's Rule directly to the limit L ? *Your answer may contain either English, mathematical symbols, or both.*

Solution

Write the product $f(x)g(x)$ as a quotient instead. For example, $\frac{g(x)}{1/f(x)}$.

- 5 p** 116. Suppose the function f has domain $(-\infty, \infty)$. Give a brief explanation of how you would find all horizontal asymptotes of f . Note that for this problem, f is unspecified; you should not assume it has any particular form. *Your answer may contain either English, mathematical symbols, or both.*

Solution

Compute the limit of f as $x \rightarrow \infty$ and the limit of f as $x \rightarrow -\infty$. If either (or both) of these limits is finite and, say, equal to L , then the line $y = L$ is a horizontal asymptote of f . (Note that f can have zero, one, or two horizontal asymptotes.)

- 10 p** 117. A boat is pulled toward a dock by a rope through a ring on the dock 4 ft above the front of the boat. The rope is hauled in at the rate of 12 ft/sec.

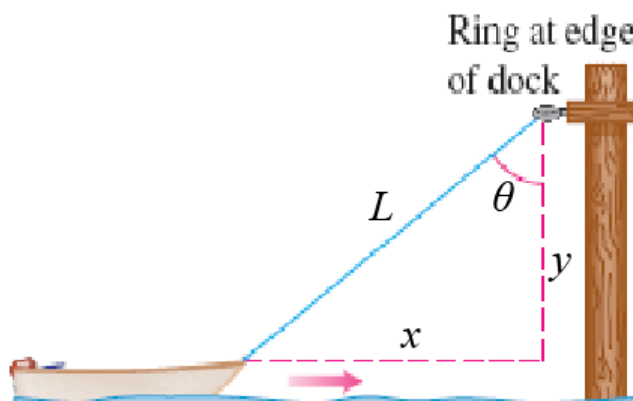

- Which of the marked variables (x , y , L , and θ) are changing over time?
- Write a mathematical equation that expresses the English sentence “The rope is hauled in at the rate of 12 ft/sec”.
- Is $\cos(\theta)$ increasing, decreasing, or constant?
- Write a mathematical expression for “the rate at which the boat approaches the dock”.
- How fast in ft/sec is the boat approaching the dock when the rope is 5 ft long?

Solution

- (a) The variables x , L , and θ are changing over time.
- (b) $\frac{dL}{dt} = -12$
- (c) Since θ is decreasing (to 0), $\cos(\theta)$ is increasing (to 1). Alternatively, note that $\cos(\theta) = \frac{4}{L}$. Since L is decreasing, the fraction $\frac{4}{L}$ is increasing.
- (d) $\left| \frac{dx}{dt} \right|$ is correct, but $\frac{dx}{dt}$ or $-\frac{dx}{dt}$ is also acceptable.
- (e) The Pythagorean theorem gives $x^2 + 16 = L^2$, whence $2x \frac{dx}{dt} = 2L \frac{dL}{dt}$. At the moment when $L = 5$, we have $x = 3$. Substituting these values and $\frac{dL}{dt} = -12$ into the second equation then gives $\frac{dx}{dt} = -20$ ft/sec. So the boat approaches the dock at a rate of 20 ft/sec.

10 p**118.** Consider the curve described by the equation

$$5x^2 - 4xy + y^2 = 8$$

At any point on this curve, we have

$$\frac{dy}{dx} = \frac{-5x + 2y}{-2x + y}$$

- (a) Describe in two or three sentences the steps you should take to find each point on the curve where the tangent line is parallel to the line $y = x$. *Your answer may contain either English, mathematical symbols, or both.*
- (b) What is the leftmost (i.e., least x -coordinate) point on the curve where the tangent line is parallel to $y = x$?
- (c) Describe in one or two sentences how parts (a) and (b) would change if instead you wanted to find the points where the tangent line is perpendicular to the line $y = 4$. You do not have to solve the problem again, but only describe generally what you would do differently. *Your answer may contain either English, mathematical symbols, or both.*

Solution

- (a) The point must lie on the curve and the tangent line has slope 1 (i.e., $\frac{dy}{dx} = 1$). So we must solve the following simultaneous set of equations for x and y .

$$\begin{aligned} 5x^2 - 4xy + y^2 &= 8 \\ \frac{-5x + 2y}{-2x + y} &= 1 \end{aligned}$$

(Note that the second equation is equivalent to $y = 3x$.)

- (b) Substituting $y = 3x$ into the original equation gives $5x^2 - 4x(3x) + (3x)^2 = 8$, or $2x^2 = 8$. Hence $x = -2$ or $x = 2$. The x -coordinate of the leftmost point with a tangent line parallel to $y = x$ is $x = -2$. We have $y = 3x$, whence the y -coordinate is $y = -6$.
- (c) The line $y = 4$ is horizontal, so a perpendicular line is vertical. A vertical tangent line has an undefined slope, so we replace the equation $\frac{dy}{dx} = 0$ with “denominator of $\frac{dy}{dx}$ is 0”. That

is, we must solve the following simultaneous set of equations:

$$\begin{aligned}5x^2 - 4xy + y^2 &= 8 \\ -2x + y &= 0\end{aligned}$$

4 p 119. Which of the following are indeterminate forms? Recall that in this course, we have learned that limits with indeterminate forms may often be computed using L'Hospital's Rule.

- | | | |
|------------------------------|-------------------------|------------------------------|
| (a) $\frac{0}{0}$ | (d) $\frac{0}{\infty}$ | (g) $\infty \cdot (-\infty)$ |
| (b) $0 \cdot \infty$ | (e) 2^∞ | (h) ∞^0 |
| (c) $\frac{\infty}{-\infty}$ | (f) $3 \cdot (-\infty)$ | (i) ∞^∞ |

Solution

The only indeterminate forms are (a), (b), (c), and (h). The other choices are equivalent to, respectively: (d) 0, (e) ∞ , (f) $-\infty$, (g) $-\infty$, and (i) ∞ .

4 p 120. Determine which of the following limits are equal to $-\infty$. Select all that apply.

- | | |
|---|--|
| (a) $\lim_{x \rightarrow 6^-} \left(\frac{x^2 - 5x - 6}{x - 6} \right)$ | (c) $\lim_{x \rightarrow \infty} \left(\frac{x^2 - 5x - 6}{x - 6} \right)$ |
| (b) $\lim_{x \rightarrow 6^-} \left(\frac{x^2 - 5x - 6}{x^2 - 12x + 36} \right)$ | (d) $\lim_{x \rightarrow \infty} \left(\frac{x^2 - 5x - 6}{x^2 - 12x + 36} \right)$ |

Solution

Choice (b) only.

- (a) Direct substitution gives $\frac{0}{0}$, so use L'Hospital's Rule.

$$\lim_{x \rightarrow 6^-} \left(\frac{x^2 - 5x - 6}{x - 6} \right) \stackrel{H}{=} \lim_{x \rightarrow 6^-} \left(\frac{2x - 5}{1} \right) = 7$$

- (b) Direct substitution gives $\frac{0}{0}$, so use L'Hospital's Rule.

$$\lim_{x \rightarrow 6^-} \left(\frac{x^2 - 5x - 6}{x^2 - 12x + 36} \right) \stackrel{H}{=} \lim_{x \rightarrow 6^-} \left(\frac{2x - 5}{2x - 12} \right) = \frac{7}{0^-} = -\infty$$

- (c) Factor out the highest power of numerator and denominator.

$$\lim_{x \rightarrow \infty} \left(\frac{x^2 - 5x - 6}{x - 6} \right) = \lim_{x \rightarrow \infty} \left(\frac{x^2}{x} \cdot \frac{1 - \frac{5}{x} - \frac{6}{x^2}}{1 - \frac{6}{x}} \right) = \lim_{x \rightarrow \infty} \left(x \cdot \frac{1 - \frac{5}{x} - \frac{6}{x^2}}{1 - \frac{6}{x}} \right) = \infty$$

- (d) Factor out the highest power of numerator and denominator.

$$\lim_{x \rightarrow \infty} \left(\frac{x^2 - 5x - 6}{x^2 - 12x + 36} \right) = \lim_{x \rightarrow \infty} \left(\frac{1 - \frac{5}{x} - \frac{6}{x^2}}{1 - \frac{12}{x} + \frac{36}{x^2}} \right) = \frac{1 - 0 - 0}{1 - 0 + 0} = 1$$

4 p

121. The numbers a , b , and c (which are not necessarily positive) satisfy the formula $a = \frac{b}{c}$. The choices below describe scenarios in which the numbers a , b , and c are changing over time. For each part, mark “T” if the statement is true or mark “F” if the statement is false. You do not have to explain your answers or show any work.

Hint: There is at most one true statement.

- (a) T F Suppose a , b , and c are all positive numbers. If a and b are both increasing, then c must also be increasing.
- (b) T F Suppose b is a positive number and c is a negative number. If b and c are both increasing, then a must be decreasing.
- (c) T F Suppose a , b , and c are all positive numbers. If a is constant, then it is possible for b and c to change in opposite ways (i.e., one can increase while the other decreases).
- (d) T F Suppose c is a positive number. If b is constant and c is increasing, then a must be decreasing.

Solution

Choice (b) is the only true scenario.

To solve this problem, we first use implicit differentiation with respect to time to obtain

$$a' = \frac{cb' - bc'}{c^2}$$

where the primes denote differentiation with respect to t .

- (a) **False.** Put $b = c = 1$, $a' = 2$, and $b' = 1$. Then we have $2 = 1 - c'$, whence $c' = -1$. So it is possible for c to be decreasing.
- (b) **True.** We have $b > 0$, $c < 0$, $b' > 0$, and $c' > 0$. A sign analysis of a' gives:

$$a' = \frac{\ominus\oplus - \oplus\oplus}{\oplus} = \frac{\ominus - \oplus}{\oplus}$$

Note that a negative number minus a positive number is a negative number. So the numerator above is negative, whence a' must be negative.

- (c) **False.** If a is constant, then $a' = 0$, and we must have $cb' = bc'$, or $b'/c' = b/c$. The right side of this equation is positive, whence b'/c' must also be positive. This means that b' and c' must both have the same sign, i.e., b and c cannot change in opposite ways.
- (d) **False.** If b is constant, then $b' = 0$, and we must have $a' = -\frac{bc'}{c^2}$. Since c and c' are both positive, we may take $c = c' = 1$ and $b = -1$, whence $a' = 1$. So it is possible for a to be increasing.

8 p

122. If x units are produced, the total cost is $C(x) = x^2 + 15x + 24$ and the selling price per unit is

$$p(x) = \frac{156}{x^2 - 4x + 16}$$

- (a) What is the exact cost of producing the 3rd unit?
- (b) Using marginal analysis, estimate the revenue from the 3rd unit sold.

Solution

(a) $C(3) - C(2) = 20$

(b) The revenue is

$$R(x) = xp(x) = \frac{156x}{x^2 - 4x + 16}$$

So by marginal analysis, the revenue from the 3rd unit is approximately

$$R'(2) = \left(\frac{156(16 - x^2)}{(x^2 - 4x + 16)^2} \right) \Big|_{x=2} = 13$$

Midterm Exam #3

12 p

123. For each part, sketch the graph of a function that satisfies the given properties.

- (a) $f(x)$ is decreasing for all x ; $f''(x) < 0$ for $x < 13$; $f''(x) > 0$ for $x > 13$.
 (b) $f(x)$ has a local minimum at $x = a$ where $f'(a) = 0$.
 (c) $f(x)$ has a local maximum at $x = b$ where $f'(b)$ is undefined.

Solution

- (a) Here is one possibility.

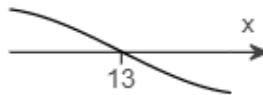

- (b) Here is one possibility.

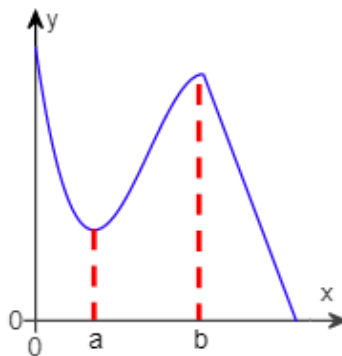

- (c) Here is one possibility.

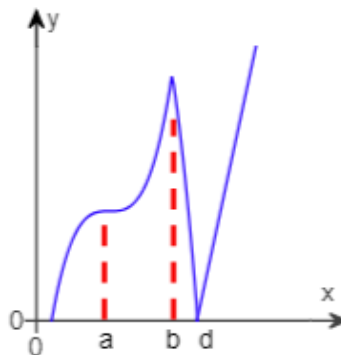

- 8 p** 124. Determine from the given graph whether the function has any absolute extreme values on (a, b) .

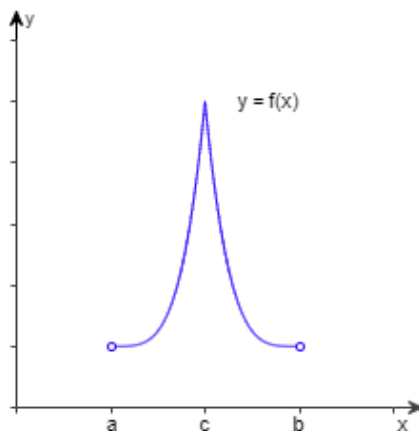

Solution

The function has an absolute maximum value at $x = c$ but does not have an absolute minimum value on (a, b) .

- 12 p** 125. Suppose f is a continuous function such that all of the following hold:

$$\int_{-1}^6 f(x) dx = -15 \quad , \quad \int_6^9 f(x) dx = 14 \quad , \quad \int_0^9 f(x) dx = 19$$

Calculate the quantities below or determine there is not enough information.

- (a) $\int_{-1}^9 f(x) dx$ (c) $\int_{-1}^6 |f(x)| dx$ (e) $\int_{-1}^0 f(x) dx$
 (b) $\int_0^6 f(x) dx$ (d) $\left| \int_{-1}^6 f(x) dx \right|$ (f) $\int_6^9 (3f(x) + 4) dx$

Solution

(a) $\int_{-1}^9 f(x) dx = \int_{-1}^6 f(x) dx + \int_6^9 f(x) dx = -15 + 14 = -1$

(b) $\int_0^6 f(x) dx = \int_0^9 f(x) dx - \int_6^9 f(x) dx = 19 - 14 = 5$

(c) not enough information

(d) $\left| \int_{-1}^6 f(x) dx \right| = |-15| = 15$

(e) Use part (b).

$$\int_{-1}^0 f(x) dx = \int_{-1}^6 f(x) dx - \int_0^6 f(x) dx = -15 - 5 = -20$$

(f) Use linearity.

$$\int_6^9 (3f(x) + 4) dx = 3 \int_6^9 f(x) dx + \int_6^9 4 dx$$

The second integral is the area of a rectangle of height 4 and width 3. So we have:

$$\int_6^9 (3f(x) + 4) dx = 3 \cdot 14 + 3 \cdot 4 = 54$$

12 p 126. Use the graph of $y = f(x)$ to calculate the integrals below.

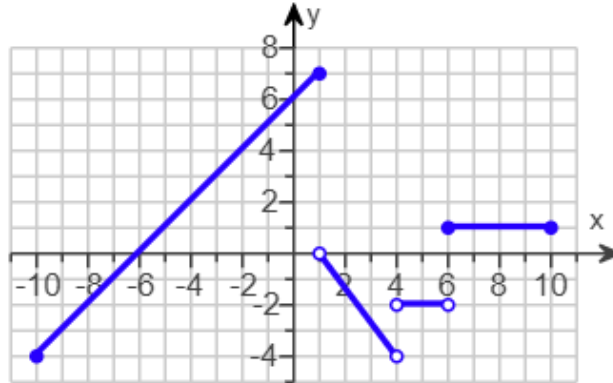

(a) $\int_0^1 f(x) dx$

(b) $\int_1^6 f(x) dx$

(c) $\int_{-10}^{10} f(x) dx$

Solution

- (a) The integral is the area of a trapezoid with parallel bases of length 6 and 7, with height 1. Hence

$$\int_0^1 f(x) dx = \frac{1}{2}(6 + 7) \cdot 1 = 6.5$$

- (b) The integral represents the net area of a region that consists of a triangle (base 3, height 4) and a rectangle (base 2, height 2). Note that both are below the x -axis, and so the net area is negative.

$$\int_1^6 f(x) dx = -\left(\frac{1}{2} \cdot 3 \cdot 4 + 2 \cdot 2\right) = -10$$

- (c) We have already computed most of this integral in parts (a) and (b). For the remaining parts we have one triangle below the x -axis, one triangle above the x -axis, and one rectangle above the x -axis.

$$\int_{-10}^{-6} f(x) dx = -\frac{1}{2} \cdot 4 \cdot 4 = -8$$

$$\int_{-6}^0 f(x) dx = \frac{1}{2} \cdot 6 \cdot 6 = 18$$

$$\int_6^{10} f(x) dx = 1 \cdot 4 = 4$$

Putting everything together gives:

$$\int_{-10}^{10} f(x) dx = -8 + 18 + 6.5 - 10 + 4 = 10.5$$

14 p 127. The first two derivatives of the function f are given below.

$$f'(x) = \frac{x}{(x-6)^2(x+48)} \quad , \quad f''(x) = \frac{-2(x+12)^2}{(x-6)^3(x+48)^2}$$

(Do not attempt to find a formula for $f(x)$.)

Fill in the table below with information about the graph of $y = f(x)$. For each part, write "NONE" as your answer if appropriate. Where applicable, give a comma-separated list of intervals that are as inclusive as possible.

You do not have to show work, and each table item will be graded with no partial credit.

Solution

where f is decreasing	$(-48, 0]$
where f is increasing	$(-\infty, -48), [0, 6), (6, \infty)$
x -coordinate(s) of local minima of f	$x = 0$
x -coordinate(s) of local maxima of f	NONE
where f is concave down	$(6, \infty)$
where f is concave up	$(-\infty, -48), (-48, 6)$
x -coordinate(s) of inflection point(s) of f	NONE

The derivatives of f are

$$f'(x) = \frac{x}{(x-6)^2(x+48)} \quad , \quad f''(x) = \frac{-2(x+12)^2}{(x-6)^3(x+48)^2}$$

(i) *Vertical asymptotes and horizontal asymptotes.*

Not required since $f(x)$ is not given.

(ii) *Intervals of increase and local extrema.*

We calculate a sign chart for the first derivative. The cut points are the solutions to $f'(x) = 0$ ($x = 0$) and where $f'(x)$ is undefined ($x = -48$ and $x = 6$).

interval	test point	sign of f'	shape of f
$(-\infty, -48)$	$f'(-50)$	$\frac{\ominus}{\oplus \ominus} = \oplus$	increasing
$(-48, 0)$	$f'(-1)$	$\frac{\ominus}{\oplus \oplus} = \ominus$	decreasing
$(0, 6)$	$f'(1)$	$\frac{\oplus}{\oplus \oplus} = \oplus$	increasing
$(6, \infty)$	$f'(7)$	$\frac{\oplus}{\oplus \oplus} = \oplus$	increasing

Hence we deduce the following about f :

f is decreasing on: $(-48, 0]$
 f is increasing on: $(-\infty, -48), [0, 6), (6, \infty)$
 f has a local min at: $x = 0$
 f has a local max at: *none*

(iii) *Intervals of concavity and inflection points.*

We calculate a sign chart for the second derivative: The cut points are the solutions to $f''(x) = 0$ ($x = -12$) and where $f''(x)$ is undefined ($x = -48$ and $x = 6$).

interval	test point	sign of f''	shape of f
$(-\infty, -48)$	$f''(-50)$	$\frac{-2}{\oplus} = \oplus$	concave up
$(-48, -12)$	$f''(-20)$	$\frac{-2}{\oplus} = \oplus$	concave up
$(-12, 6)$	$f''(0)$	$\frac{-2}{\oplus} = \oplus$	concave up
$(6, \infty)$	$f''(7)$	$\frac{-2}{\oplus} = \ominus$	concave down

Hence we deduce the following about f :

f is concave down on: $(6, \infty)$
 f is concave up on: $(-\infty, -48), (-48, 6)$
 f has an infl. point at: *none*

(iv) *Sketch of graph.*

Not required.

8 p

128. Let x be the level of production for a certain commodity. The marginal cost is modeled by the function

$$\frac{dC}{dx} = 3x^2 + 2x$$

and the market price is modeled by the function

$$p(x) = 144 - 2x$$

Suppose that the cost of producing the 1st unit of the commodity is 70.

- What is the cost of producing the first 3 units of the commodity?
- What is the level of production that maximizes the total profit?

Solution

(a) The total cost must have the following form:

$$C(x) = \int \frac{dC}{dx} dx = \int (3x^2 + 2x) dx = x^3 + x^2 + K$$

where K is some constant. The condition $C(1) = 70$ gives $1 + 1 + K = 70$, whence $K = 68$. So the total cost function is $C(x) = x^3 + x^2 + 68$. Hence the cost of the first 3 units is $C(3) = 104$.

(b) The total revenue is $R(x) = xp(x) = 144x - 2x^2$. Total profit is maximized when $C'(x) = R'(x)$, or when $3x^2 + 2x = 144 - 4x$. The solutions to this equation are $x = -8$ and $x = 6$.

Hence the total profit is maximized when $x = 6$ (production cannot be negative).

8 p 129. Consider the following function

$$g(x) = \frac{3}{2}x^4 + 8x^3 - 36x^2$$

- (a) Where does g have a local minimum on $(-7, 3)$? local maximum?
 (b) Where does g have a global minimum on $[-7, 3]$? global maximum?

Solution

(a) We solve $g'(x) = 0$ to find the critical points of g .

$$g'(x) = 6x^3 + 24x^2 - 72x = 6x(x - 2)(x + 6) = 0$$

Thus the critical points are $x = -6$, $x = 0$, and $x = 2$ (all of which are in $(-7, 3)$). We will use the second derivative test to classify these critical points.

$$g''(x) = 6(3x^2 + 8x - 12)$$

x	-6	0	2
$g''(x)$	288	-72	96

Hence g has a local minimum at both $x = -6$ and $x = 2$, and g has a local maximum at $x = 0$.

- (b) The global extrema can occur only at the endpoints of the interval or at the critical points. We have the following values:

x	-7	-6	0	2	3
$g(x)$	-906	-1080	0	-56	13.5

Hence on the interval $[-7, 3]$, g has a global minimum at $x = -6$ and a global maximum at $x = 3$.

8 p 130. Find all critical points of the function

$$f(x) = 2x^{4/3} - 16x^{2/3} + 24$$

Note: The function f is continuous on the interval $(-\infty, \infty)$.

Solution

The first derivative of f is

$$f'(x) = \frac{8}{3}x^{1/3} - \frac{32}{3}x^{-1/3} = \frac{8(x^{2/3} - 4)}{3x^{1/3}}$$

We immediately find that $x = 0$ is a critical point since $f'(0)$ does not exist. The remaining critical points are solutions of $f'(x) = 0$.

$$f'(x) = 0 \implies x^{2/3} - 4 = 0 \implies x^2 = 64 \implies x = -8 \text{ or } x = 8$$

Hence the critical points of f are $x = -8$, $x = 0$, and $x = 8$.

18 p

131. Suppose the local post office has a policy that all packages must be shaped like a rectangular box with a sum of length, width, and height not exceeding 144 inches. You plan to construct such a package whose length is 2 times its width. Find the dimensions of the package with the largest volume. For this problem, let L , W , and H be the length, width, and height of the package, respectively.

- (a) What is the objective function for this problem in terms of L , W , and H ?
- (b) There are two constraints for this problem. In terms of L , W , and H , give the constraint equation which corresponds to...
 - (i) ...the policy set by the post office.
 - (ii) ...your specific plan to construct such a package.
- (c) Find the objective function in terms of W only.
- (d) What is the interval of interest for the objective function?
- (e) Find the values of L , W , and H that give the largest volume.
- (f) Suppose the post office adds the additional requirement that the width W of the package must be no smaller than 36 inches and no larger than 40 inches. With this additional policy, what is the width of the package with the largest volume?

Solution

- (a) We seek to maximize the volume of the package, so our objective is $g(L, W, H) = LWH$.
- (b)
 - (i) $L + W + H = 144$
 - (ii) $L = 2W$
- (c) We already have $L = 2W$. From the first constraint, we get $3W + H = 144$, whence $H = 144 - 3W$. Hence the objective function in terms of W only is

$$f(W) = g(2W, W, 144 - 3W) = 2W^2(144 - 3W) = 288W^2 - 6W^3$$

- (d) Each of L , W , and H must be non-negative numbers. (We allow them to be 0, since this would correspond to a degenerate package with no volume. That is okay.) The condition $L \geq 0$ is equivalent to $W \geq 0$ since $L = 2W$. The condition $H \geq 0$ is equivalent to $144 - 3W \geq 0$, or $W \leq 48$. Hence the interval of interest (possible values of W) is $[0, 48]$.
- (e) The critical points of f are solutions to $f'(W) = 576W - 18W^2 = 18W(32 - W) = 0$. Hence the two critical points are $W = 0$ (already included as an endpoint) and $W = 32$. Since we are working on a closed interval, we may verify that $W = 32$ is the global maximum simply by checking the endpoint and critical values. Since $f(0) = f(48) = 0$ and $f(32) > 0$, it is clear that $W = 32$ gives the global maximum.

Hence the dimensions of the package with the largest volume are $L = 64$, $W = 32$, and $H = 48$.

- (f) None of our previous work has changed except that the interval of interest is now $[36, 40]$. We have already determined that $f(W)$ has a global maximum on $[0, 48]$ at $W = 32$. Hence f is decreasing on the interval $[36, 40]$. Hence $f(36) > f(40)$, and so the package with the largest volume now has $W = 36$.

1.7 Summer 2020

Midterm Exam #1

12 p 132. For each part, use the graph of $f(x)$ below.

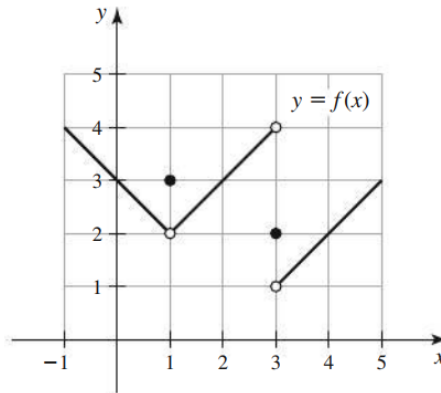

- (a) Calculate $\lim_{x \rightarrow 3} f(x)$ or determine that the limit does not exist.
 (b) Find all values of a such that both $\lim_{x \rightarrow a} f(x)$ exists and this limit is not equal to $f(a)$.

Solution

- (a) $\lim_{x \rightarrow 3} f(x)$ does not exist.
 (b) $a = 1$ only.

24 p 133. For each part, calculate the limit or show that it does not exist. If the limit is “ $+\infty$ ” or “ $-\infty$ ”, write that as your answer, instead of “does not exist”.

(a) $\lim_{x \rightarrow 3} \left(\frac{x^3 + 2x^2 - 15x}{x^2 - 9} \right)$ (b) $\lim_{x \rightarrow 0} \left(\frac{\sin(6x)^2}{x^2 \cos(2x)} \right)$

Solution

- (a) Factor and cancel.

$$\lim_{x \rightarrow 3} \left(\frac{x^3 + 2x^2 - 15x}{x^2 - 9} \right) = \lim_{x \rightarrow 3} \left(\frac{x(x+5)(x-3)}{(x+3)(x-3)} \right) = \lim_{x \rightarrow 3} \left(\frac{x(x+5)}{x+3} \right) = \frac{3 \cdot 8}{6} = 4$$

- (b) First we regroup terms and add factors of 6 to use the special trigonometric limit.

$$\lim_{x \rightarrow 0} \left(\frac{\sin(6x)^2}{x^2 \cos(2x)} \right) = \lim_{x \rightarrow 0} \left(\frac{\sin(6x)}{6x} \cdot \frac{\sin(6x)}{6x} \cdot \frac{36}{\cos(2x)} \right)$$

Now we compute the limit of each factor and use the special limit $\lim_{x \rightarrow 0} \left(\frac{\sin(6x)}{6x} \right) = 1$.

$$\lim_{x \rightarrow 0} \left(\frac{\sin(6x)}{6x} \cdot \frac{\sin(6x)}{6x} \cdot \frac{36}{\cos(2x)} \right) = 1 \cdot 1 \cdot \frac{36}{1} = 36$$

12 p 134. The parts of this problem are related.

- (a) Suppose $x < 3$. Write an algebraic expression that is equivalent to $|x - 3|$ but without absolute value symbol.
- (b) Calculate $\lim_{x \rightarrow 2} \left(\frac{|x - 3| - 1}{x - 2} \right)$. Explain why your work to part (a) is relevant here and precisely where you use it.

Solution

- (a) If $x < 3$, then $x - 3 < 0$, whence $|x - 3| = -(x - 3) = 3 - x$.
- (b) Part (a) is relevant here since we want to calculate a limit as $x \rightarrow 2$ and $x = 2$ satisfies the inequality $x < 3$. Hence, for all x sufficiently close to 2 (on both sides), we have $|x - 3| = 3 - x$. Now we may compute the limit.

$$\lim_{x \rightarrow 2} \left(\frac{|x - 3| - 1}{x - 2} \right) = \lim_{x \rightarrow 2} \left(\frac{(3 - x) - 1}{x - 2} \right) = \lim_{x \rightarrow 2} \left(\frac{2 - x}{x - 2} \right) = \lim_{x \rightarrow 2} (-1) = -1$$

13 p 135. The parts of this problem are related.

- (a) Consider the function below.

$$f(x) = \begin{cases} \frac{x - 1}{3 - \sqrt{10 - x}} & x \neq 1 \\ -6 & x = 1 \end{cases}$$

Show that $\lim_{x \rightarrow 1} f(x) \neq f(1)$.

- (b) Now consider the similar function below.

$$g(x) = \begin{cases} \frac{x - 1}{3 - \sqrt{10 - x}} & x \neq 1 \\ b & x = 1 \end{cases}$$

where b is an unspecified constant. Explain how to determine whether the following statement is true: $\lim_{x \rightarrow 1} g(x) \neq g(1)$. How does your work for part (a) change, if at all, to determine the truth of the statement? Explain your answer.

Solution

- (a) Rationalize the denominator.

$$\begin{aligned} \lim_{x \rightarrow 1} f(x) &= \lim_{x \rightarrow 1} \left(\frac{x - 1}{3 - \sqrt{10 - x}} \cdot \frac{3 + \sqrt{10 - x}}{3 + \sqrt{10 - x}} \right) = \lim_{x \rightarrow 1} \left(\frac{(x - 1)(3 + \sqrt{10 - x})}{9 - (10 - x)} \right) \\ &= \lim_{x \rightarrow 1} \left(\frac{(x - 1)(3 + \sqrt{10 - x})}{x - 1} \right) = \lim_{x \rightarrow 1} (3 + \sqrt{10 - x}) = 3 + \sqrt{10 - 1} = 6 \end{aligned}$$

Observe that $6 \neq -6 = f(1)$.

- (b) The function value $g(1)$ has no effect on our calculation of $\lim_{x \rightarrow 1} g(x)$, which is equal to $\lim_{x \rightarrow 1} f(x) = 6$. Hence our work from part (a) does not change – we need only check whether $b = 6$.

- 13 p** **136.** Let $f(x) = 8 - \frac{1}{5x}$. Fully simplify the difference quotient $\frac{f(x+h) - f(x)}{h}$ with $h \neq 0$. In your work, make clear where you use the assumption $h \neq 0$.

Solution

We have the following.

$$\begin{aligned} \frac{f(x+h) - f(x)}{h} &= \frac{\left(8 - \frac{1}{5(x+h)}\right) - \left(8 - \frac{1}{5x}\right)}{h} = \frac{-\frac{1}{5(x+h)} + \frac{1}{5x}}{h} \\ &= \frac{-\frac{1}{5(x+h)} + \frac{1}{5x}}{h} \cdot \frac{5x(x+h)}{5x(x+h)} = \frac{-x + (x+h)}{5hx(x+h)} = \frac{h}{5hx(x+h)} \end{aligned}$$

At this point, since $h \neq 0$, we may cancel the common factor of h and obtain our final answer.

$$\frac{f(x+h) - f(x)}{h} = \frac{1}{5x(x+h)}$$

- 14 p** **137.** For both parts of this problem, consider the following inequality.

$$\frac{(x-3)(x-6)}{x-5} < 0$$

Your goal is to identify an error in a false solution of this inequality, and then to solve the inequality yourself.

- (a) A student submits the following work for solving this equality.

“First we multiply both sides by $(x-5)$. On the left side, this factor cancels, and on the right side we get 0. So we have $(x-3)(x-6) < 0$. The graph of $y = (x-3)(x-6)$ is a parabola that opens upward and crosses the x -axis at $x = 3$ and $x = 6$. This means that the graph is below the x -axis between these two x -values. So the solution to $(x-3)(x-6) < 0$ is the interval $(3, 6)$. But since the original inequality was undefined at $x = 5$, we also have to exclude 5. So the final answer is $(3, 5) \cup (5, 6)$.”

The student’s teacher does not give full credit for this solution, simply noting that $x = 4$ is included in the student’s answer, but $x = 4$ does not satisfy the original inequality. So the final answer must be wrong.

What is the student’s error? Be as specific as possible and explain why this is an error. *To explain why the given solution is wrong, it is not enough to simply write the correct solution and observe that the two solutions are different.*

- (b) Solve the original inequality. Write your answer using interval notation.

Solution

- (a) The quantity $(x-5)$ may take negative values (i.e., if $x < 5$), and in that case, multiplying both sides of the inequality by $(x-5)$ would reverse the direction of the inequality. The student’s work implicitly assumes that $(x-5)$ is positive throughout, evident by the student’s not reversing the direction of the inequality. The student’s primary error is then never properly considering the case in which $(x-5) < 0$.
- (b) We will use the method of sign charts. The cut points for our number line are $x = 3$, $x = 5$, and $x = 6$.

interval	test point	sign of $\frac{(x-3)(x-6)}{(x-5)}$	truth of inequality
$(-\infty, 3)$	$x = 0$	$\frac{\ominus\ominus}{\ominus} = \ominus$	true
$(3, 5)$	$x = 4$	$\frac{\oplus\ominus}{\ominus} = \oplus$	false
$(5, 6)$	$x = 5.5$	$\frac{\oplus\oplus}{\oplus} = \ominus$	true
$(6, \infty)$	$x = 7$	$\frac{\oplus\oplus}{\oplus} = \oplus$	false

Hence the solution to the inequality is $(-\infty, 3) \cup (5, 6)$.

12 p

138. Consider the function below.

$$f(x) = \begin{cases} x^2 + 4x - 1 & x < 2 \\ 11 & x = 2 \\ 19 - x^3 & x > 2 \end{cases}$$

A student correctly calculates that $\lim_{x \rightarrow 2} f(x) = 11$ and enters this as their final answer on an online exam, initially getting full credit. However, after inspecting the student's work, the teacher overrides this score and gives no credit. The teacher writes the comment "you have not correctly justified your answer." The student wrote the following:

"Since $f(x)$ is defined for all x and $f(2) = 11$, the answer is $\lim_{x \rightarrow 2} f(x) = 11$."

- (a) Why is the student's justification incorrect?
- (b) Write a complete and correct justification for the statement $\lim_{x \rightarrow 2} f(x) = 11$.

Solution

- (a) Even though the student's final answer is correct, the value of a function at $x = a$ is irrelevant to the calculation of $\lim_{x \rightarrow a} f(x)$. (For instance, it's possible for $f(a)$ and $\lim_{x \rightarrow a} f(x)$ to be different.) So the justification is incorrect.
- (b) Note that $x = 2$ is the transition point of the piecewise-defined function $f(x)$. So we will justify the statement $\lim_{x \rightarrow 2} f(x) = 11$ using one-sided limits.

$$\lim_{x \rightarrow 2^-} f(x) = \lim_{x \rightarrow 2^-} (x^2 + 4x - 1) = 4 + 8 - 1 = 11$$

$$\lim_{x \rightarrow 2^+} f(x) = \lim_{x \rightarrow 2^+} (19 - x^3) = 19 - 8 = 11$$

Since the left-limit and right-limit are both equal to 11, we conclude that $\lim_{x \rightarrow 2} f(x) = 11$.

Midterm Exam #2

10 p

139. Let $h(x) = \frac{f(x)}{g(x)}$, where f and g are continuous and $\lim_{x \rightarrow a} g(x) = 0$. Is the following true or false?

“The line $x = a$ is necessarily a vertical asymptote of $h(x)$.”

You must justify your answer. This means that if your answer is “true”, you should explain why the above statement is always true. If your answer is “false”, you should give an example to show that the above statement is sometimes false.

Solution

False. The issue here is that if $\lim_{x \rightarrow a} f(x) = 0$ also, then h may or may not have a vertical asymptote at $x = a$.

For an explicit example, let $f(x) = g(x) = x$. Then f and g are continuous for all x and $\lim_{x \rightarrow 0} g(x) = 0$, but $\frac{f(x)}{g(x)}$ does not have a vertical asymptote at $x = 0$ since $\lim_{x \rightarrow 0} \frac{f(x)}{g(x)} = 1$.

10 p

140. Suppose that as x increases to 1, the values of $f(x)$ get larger and larger, and the values stay positive. Is the following true or false?

“Therefore, $\lim_{x \rightarrow 1^-} f(x) = +\infty$.”

You must justify your answer. This means that if your answer is “true”, you should explain why the above statement is always true. If your answer is “false”, you should give an example to show that the above statement is sometimes false.

Solution

False. The issue here is that the phrase “larger and larger” does not imply “arbitrarily large”, which is the more accurate description of what it means for a limit to be infinite.

For an explicit example, let $f(x) = x$. Then the values of $f(x)$ get larger and larger (i.e., increase) as x increases to 1. But $\lim_{x \rightarrow 1^-} f(x) = 1$.

10 p

141. In a certain parking garage, the cost of parking is \$20 per hour or any fraction thereof. For example, if you are in the garage for two hours and fifteen minutes, you pay \$60 (\$20 for the first hour, \$20 for the second hour, and \$20 for the fifteen-minute portion of the third hour). Let $P(t)$ be the cost of parking for t hours, where t is any non-negative real number. For example, $P(2.25) = 60$. Is the following true or false?

“ $P(t)$ is a continuous function of t .”

You must justify your answer.

Solution

False. The function $P(t)$ has a jump discontinuity at each non-negative integer (i.e., at $t = 0$, $t = 1$, $t = 2$, etc.).

For instance, the cost of parking for 1 hour or less is \$20. However, as soon as you are in the garage one moment past 1 hour, the price jumps to \$40. Mathematically, this means all of the following: $\lim_{t \rightarrow 1^-} P(t) = 20$, $\lim_{t \rightarrow 1^+} P(t) = 40$, and $P(1) = 20$. Hence $P(t)$ is not continuous at $t = 1$.

(A similar argument holds for any other non-negative integer value of t .)

16 p 142. Consider the following function, where a and b are unspecified constants.

$$f(x) = \begin{cases} 3 & x \leq -1 \\ ax^2 + 2x + b & -1 < x \leq 2 \\ 14 - ax & x > 2 \end{cases}$$

Find the values of a and b for which f is continuous for all x , or determine that no such values exist. *In your work, you must use limit-based methods to solve this problem. Solutions that have work that is not based on limits will not receive full credit.*

Solution

Each piece of f is continuous for all x , so we need only force continuity at the transition points, $x = -1$ and $x = 2$. At each of these x -values, to have continuity, the left-limit, right-limit, and function value must all be equal. For $x = -1$, we must have:

$$\begin{aligned} \lim_{x \rightarrow -1^-} f(x) &= \lim_{x \rightarrow -1^-} (3) = 3 \\ \lim_{x \rightarrow -1^+} f(x) &= \lim_{x \rightarrow -1^+} (ax^2 + 2x + b) = a - 2 + b \\ f(-1) &= (3)|_{x=-1} = 3 \end{aligned}$$

Hence we obtain $a - 2 + b = 3$, or $a + b = 5$. Now for $x = 2$, we must have:

$$\begin{aligned} \lim_{x \rightarrow 2^-} f(x) &= \lim_{x \rightarrow 2^-} (ax^2 + 2x + b) = 4a + 4 + b \\ \lim_{x \rightarrow 2^+} f(x) &= \lim_{x \rightarrow 2^+} (14 - ax) = 14 - 2a \\ f(2) &= (ax^2 + 2x + b)|_{x=2} = 4a + 4 + b \end{aligned}$$

Hence we obtain $4a + 4 + b = 14 - 2a$, or $6a + b = 10$.

To find a and b we solve the simultaneous system of equations:

$$\begin{aligned} a + b &= 5 \\ 6a + b &= 10 \end{aligned}$$

Subtracting the first equation from the second gives $5a = 5$, whence $a = 1$. Back-substitution then gives $b = 4$.

18 p 143. Let $f(x) = \frac{9x - x^3}{x^2 + x - 6}$.

- Calculate all vertical asymptotes of f . Justify your answer.
- Where is f discontinuous?
- For each point at which f is discontinuous, determine what value should be reassigned to f , if possible, to guarantee that f will be continuous there.

Solution

- Putting the denominator to 0 gives $x^2 + x - 6 = 0$, with solutions $x = -3$ or $x = 2$. Direct substitution of $x = 2$ into f gives the (undefined) expression " $\frac{10}{0}$ " (i.e., a non-zero number divided by zero). Hence $x = 2$ is a vertical asymptote. However, for $x = -3$, we observe

the following.

$$\lim_{x \rightarrow -3} \left(\frac{9x - x^3}{x^2 + x - 6} \right) = \lim_{x \rightarrow -3} \left(\frac{x(3-x)(3+x)}{(x-2)(x+3)} \right) = \lim_{x \rightarrow -3} \left(\frac{x(3-x)}{x-2} \right) = \frac{18}{5}$$

Since this limit is not infinite, the line $x = -3$ is not a vertical asymptote. The only vertical asymptote is $x = 2$.

- (b) Since f is a ratio two continuous functions, f is discontinuous only where its denominator is 0. Hence f is discontinuous only at $x = 2$ and $x = -3$.
- (c) From our work in part (a), we know that $x = 2$ is a vertical asymptote. Thus it is impossible to redefine $f(2)$ to make f continuous at $x = 2$. (Why? The limit $\lim_{x \rightarrow 2} f(x)$ does not exist.)

However, for $x = -3$, we have $\lim_{x \rightarrow -3} f(x) = \frac{18}{5}$. Hence if we redefine $f(-3)$ to be $\frac{18}{5}$, then f becomes continuous at $x = -3$.

- 12 p** 144. Let $f(x) = \frac{(x-3)(2x+1)}{(5x+2)(3x-10)}$. Calculate all horizontal asymptotes of f .

Solution

We must calculate the limits of f at infinity. First we assume $x \neq 0$ and factor out the highest power of numerator and denominator separately to prepare the calculation of those limits. In particular, we factor out x from each term.

$$\frac{(x-3)(2x+1)}{(5x+2)(3x-10)} = \frac{x^2 \cdot \left(1 - \frac{3}{x}\right) \left(2 + \frac{1}{x}\right)}{x^2 \cdot \left(5 + \frac{2}{x}\right) \left(3 - \frac{10}{x}\right)} = \frac{\left(1 - \frac{3}{x}\right) \left(2 + \frac{1}{x}\right)}{\left(5 + \frac{2}{x}\right) \left(3 - \frac{10}{x}\right)}$$

Now we note that $\lim_{x \rightarrow -\infty} \left(\frac{1}{x}\right) = \lim_{x \rightarrow +\infty} \left(\frac{1}{x}\right) = 0$. Hence we have

$$\lim_{x \rightarrow \pm\infty} f(x) = \lim_{x \rightarrow \pm\infty} \left(\frac{\left(1 - \frac{3}{x}\right) \left(2 + \frac{1}{x}\right)}{\left(5 + \frac{2}{x}\right) \left(3 - \frac{10}{x}\right)} \right) = \frac{(1-0)(2+0)}{(5+0)(3-0)} = \frac{2}{15}$$

Hence f has a single horizontal asymptote: $y = \frac{2}{15}$.

- 24 p** 145. Let $f(x) = \frac{3 + 7e^{2x}}{1 - e^x}$. Calculate each of the following limits.

(a) $\lim_{x \rightarrow -\infty} f(x)$ (b) $\lim_{x \rightarrow +\infty} f(x)$ (c) $\lim_{x \rightarrow 0^-} f(x)$

Solution

- (a) We recall that $\lim_{x \rightarrow -\infty} (e^x) = 0$, whence $\lim_{x \rightarrow -\infty} (e^{2x}) = 0$ also since $e^{2x} = (e^x)^2$. So we immediately have:

$$\lim_{x \rightarrow -\infty} f(x) = \lim_{x \rightarrow -\infty} \left(\frac{3 + 7e^{2x}}{1 - e^x} \right) = \frac{3 + 7 \cdot 0}{1 - 0} = 3$$

- (b) We recall that $\lim_{x \rightarrow +\infty} (e^x) = +\infty$, whence $\lim_{x \rightarrow +\infty} (e^{2x}) = +\infty$ also since $e^{2x} = (e^x)^2$. This

would give the indeterminate form “ $\frac{\infty}{-\infty}$ ” in our limit, so we instead factor out the “highest power” (or dominant term) as $x \rightarrow +\infty$ of the numerator and denominator separately. For the numerator, the dominant term is e^{2x} . For the denominator, the dominant term is e^x . So now we have:

$$\lim_{x \rightarrow +\infty} f(x) = \lim_{x \rightarrow +\infty} \left(\frac{e^{2x}}{e^x} \cdot \frac{3e^{-2x} + 7}{e^{-x} - 1} \right) = \lim_{x \rightarrow +\infty} \left(e^x \cdot \frac{3e^{-2x} + 7}{e^{-x} - 1} \right)$$

Now we recall that $\lim_{x \rightarrow +\infty} (e^{-x}) = 0$, whence $\lim_{x \rightarrow +\infty} (e^{-2x}) = 0$ also since $e^{2x} = (e^x)^2$. So our limit is:

$$\lim_{x \rightarrow +\infty} \left(e^x \cdot \frac{3e^{-2x} + 7}{e^{-x} - 1} \right) = \lim_{x \rightarrow +\infty} (e^x) \cdot \lim_{x \rightarrow +\infty} \left(\frac{3e^{-2x} + 7}{e^{-x} - 1} \right) = (+\infty) \cdot \frac{0 + 7}{0 - 1} = -\infty$$

- (c) Direct substitution of $x = 0$ into $f(x)$ gives the (undefined) expression “ $\frac{10}{0}$ ”, which means that both one-sided limits at $x = 0$ are infinite. So we perform a sign analysis to determine whether the limit is positive or negative infinity.

As $x \rightarrow 0^-$ the numerator $(3 + 7e^{2x}) \rightarrow 10$, which is positive. For the denominator, however, we note that e^x is an increasing function for all x . Hence $1 = e^0 > e^x$ (or $1 - e^x > 0$) for all $x < 0$. (We can deduce this from a simple graph of $y = e^x$. Alternatively, a test point shows that $1 - e^x > 0$ for all x sufficiently close to and less than 0.) Hence the denominator is positive as $x \rightarrow 0^-$. Putting this altogether gives the following:

$$\lim_{x \rightarrow 0^-} f(x) = \lim_{x \rightarrow 0^-} \left(\frac{3 + 7e^{2x}}{1 - e^x} \right) = \frac{10}{0^+} = +\infty$$

Midterm Exam #3

- 10 p** 146. Explain the relationship between $f'(3)$ and the line tangent to the graph of $y = f(x)$ at $x = 3$.

Solution

The slope of the tangent line at $x = 3$ is $f'(3)$.

- 10 p** 147. Suppose $f'(7)$ exists. What can be said about the limit $\lim_{x \rightarrow 7} f(x)$?

Solution

Since f is differentiable at $x = 7$, f must also be continuous at $x = 7$. Hence $\lim_{x \rightarrow 7} f(x)$ exists and is equal to $f(7)$.

- 15 p** 148. Consider the following limit.

$$\lim_{h \rightarrow 0} \left(\frac{(4+h)^{3/2} - 8}{h} \right)$$

Use the limit definition of derivative to identify this limit as the derivative of some function $f(x)$ at the point $x = a$. Then calculate the value of the limit.

Solution

Let $f(x) = x^{3/2}$ and $a = 4$. Then, by the definition of derivative, the given limit is equal to $f'(4)$. To compute the limit, we use the power rule to note that $f'(x) = \frac{3}{2}x^{1/2}$. So $f'(4)$, and hence the given limit, is equal to $\frac{3}{2} \cdot 4^{1/2} = 3$.

- 16 p** 149. For each part, calculate the derivative by any valid method.

(a) $f(x) = x^2 \cos(3x) + \frac{1}{5x}$

(b) $f(x) = \sqrt{\sin\left(\frac{e^x}{x+1}\right)}$

Solution

- (a) Write the second term as $\frac{1}{5x} = \frac{1}{5}x^{-1}$. Then use product rule and power rule.

$$f'(x) = 2x \cos(3x) - 3x^2 \sin(3x) - \frac{1}{5}x^{-2}$$

- (b) Use chain rule twice. For the second application of chain rule, use quotient rule.

$$f'(x) = \frac{1}{2} \left(\sin\left(\frac{e^x}{x+1}\right) \right)^{-1/2} \cos\left(\frac{e^x}{x+1}\right) \cdot \frac{e^x(x+1) - e^x \cdot 1}{(x+1)^2}$$

- 16 p** 150. Let $f(x) = x^{15}e^{2-5x}$. Find the x -coordinate of each point where the tangent line to f is horizontal.

Solution

The tangent line is horizontal wherever $f'(x) = 0$. We find the derivative using the product rule and chain rule.

$$f'(x) = 15x^{14}e^{2-5x} - 5x^{15}e^{2-5x} = 5x^{14}(3-x)e^{2-5x}$$

Solving $f'(x) = 0$, we find that there is a horizontal tangent line at $x = 0$ and $x = 3$.

15 p

151. Let $f(x) = 3x^5 - 2x^3 + 7x - 16$. Find an equation of the tangent line to f at $x = -1$.

Solution

The tangent line passes through the point $(-1, f(-1)) = (-1, -24)$. Now observe that $f'(x) = 15x^4 - 6x^2 + 7$, whence the slope of the tangent line is $f'(-1) = 16$. So an equation of the tangent line is:

$$y = -24 + 16(x + 1)$$

18 p

152. Use the graph of $y = f(x)$ below to answer the following questions.

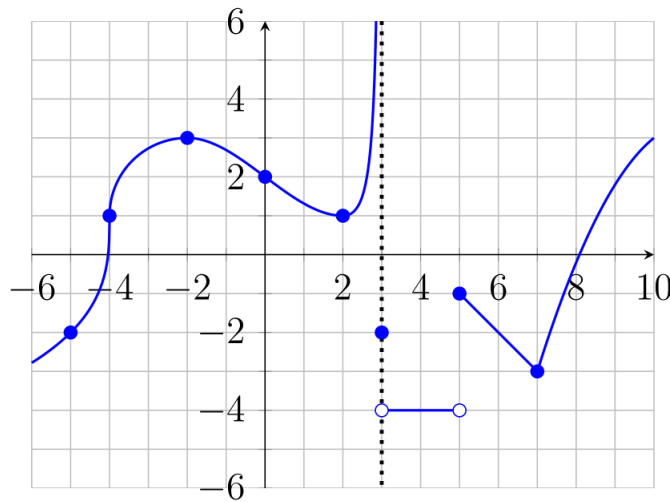

- In the interval $(-6, 10)$, where is f not differentiable?
- Calculate a reasonable estimate of $f'(0)$. Explain your reasoning.
- In the interval $(-6, 10)$, where is $f'(x) = 0$?
- In the interval $(-6, 10)$, where is $f'(x) < 0$?
- In the interval $(-6, 10)$, where is $f'(x) > 0$?

Solution

- $x = -4$, $x = 3$, $x = 5$, and $x = 7$
- We use the secant line through the points $(-2, 3)$ and $(2, 1)$ to estimate $f'(0)$. The slope of this secant line is $m = \frac{1-3}{2-(-2)} = -\frac{1}{2}$. Hence we estimate $f'(0) \approx -\frac{1}{2}$.
- $x = -2$, $x = 2$, and the interval $(3, 5)$
- $(-2, 2) \cup (5, 7)$
- $(-6, -4) \cup (-4, -2) \cup (2, 3) \cup (7, 10)$

Midterm Exam #4

18 p

153. Given that x units of a commodity are sold, the selling price per unit is $p(x) = \frac{5000}{x^2 + 64}$.

- (a) Calculate the revenue function.
 (b) Calculate the exact revenue derived from the 7th unit.
 (c) Using marginal analysis, estimate the revenue derived from the 7th unit.

Solution

(a) $R(x) = xp(x) = \frac{5000x}{x^2 + 64}$

(b) The exact revenue is

$$R(7) - R(6) = \frac{35000}{113} - \frac{30000}{100} = \frac{1100}{113} \approx 9.735$$

(c) The approximate revenue is

$$R'(6) = \left(\frac{5000(64 - x^2)}{(x^2 + 64)^2} \right) \Big|_{x=6} = \frac{5000 \cdot 28}{100^2} = 14$$

20 p

154. Consider the curve described by the equation

$$x^4 - x^2y + y^4 = 1$$

- (a) Find $\frac{dy}{dx}$ at a general point on the curve.
 (b) Find an equation of the line tangent to the curve at the point $(-1, 1)$.

Solution

(a) Use implicit differentiation.

$$4x^3 - 2xy - x^2 \cdot \frac{dy}{dx} + 4y^3 \cdot \frac{dy}{dx} = 0$$

Solving algebraically for $\frac{dy}{dx}$ gives:

$$\frac{dy}{dx} = \frac{2xy - 4x^3}{4y^3 - x^2}$$

(b) The slope of the tangent line is

$$m = \frac{dy}{dx} \Big|_{(x,y)=(-1,1)} = \left(\frac{xy - 2x^3}{4y^3 - x^2} \right) \Big|_{(x,y)=(-1,1)} = \frac{2}{3}$$

Hence an equation of the tangent line is

$$y = 1 + \frac{2}{3}(x + 1)$$

28 p

155. In a right triangle, the base is decreasing in length by 3 cm/sec and the area is increasing by 15 cm²/sec. (The triangle always remains a right triangle.) At the time when the base is 15 cm in length and the height is 20 cm in length. . .

- (a) . . . at what rate is the height changing? (Give a number only.)
 (b) . . . at what rate is the length of the hypotenuse changing? (Give a number only.)
 (c) What are the units of your answer in part (a)?
 (d) In part (b), is the length of the hypotenuse increasing, decreasing, or staying constant?

Solution

- (a) Let b , h , and A be the base, height, and the area of the triangle, respectively. Then we have $A = \frac{1}{2}bh$. Differentiating with respect to t gives:

$$\frac{dA}{dt} = \frac{1}{2} \frac{db}{dt} h + \frac{1}{2} b \frac{dh}{dt}$$

Now we substitute the given information: $\frac{db}{dt} = -3$, $\frac{dA}{dt} = 15$, $b = 15$, and $h = 20$.

$$15 = \frac{1}{2} \cdot (-3) \cdot 20 + \frac{1}{2} \cdot 15 \cdot \frac{dh}{dt}$$

Solving for $\frac{dh}{dt}$ gives $\frac{dh}{dt} = 6$.

- (b) Let the length of the hypotenuse be L . Then $b^2 + h^2 = L^2$. Differentiating with respect to t gives:

$$2b \frac{db}{dt} + 2h \frac{dh}{dt} = 2L \frac{dL}{dt}$$

When $b = 15$ and $h = 20$, we have $L = 25$. Now we also substitute the given information and our work from part (a).

$$2 \cdot 15 \cdot (-3) + 2 \cdot 20 \cdot 6 = 2 \cdot 25 \cdot \frac{dL}{dt}$$

Solving for $\frac{dL}{dt}$ gives $\frac{dL}{dt} = 3$.

- (c) The units of $\frac{dh}{dt}$ are cm/sec.
 (d) Since $\frac{dL}{dt} > 0$, the length of the hypotenuse is increasing.

16 p

156. The total number of gallons in a water tank at t hours is given by $N(t) = 40t^{2/5}$. Use a linear approximation to estimate the number of gallons added to the water between $t = 32$ and $t = 35$.

Solution

We use the tangent line to $N(t)$ at $t = 32$. The tangent line passes through the point $(32, N(32))$. The slope of the tangent line is

$$N'(32) = \left(\frac{2}{5} \cdot 40t^{-3/5} \right) \Big|_{t=32} = 16 \cdot \frac{1}{8} = 2$$

Hence the equation of the tangent line is

$$y = N(32) + 2(t - 32)$$

This means that if t is near 32, then $N(t) \approx N(32) + 2(t - 32)$. Hence the approximate number of gallons added in the described interval is

$$\Delta N = N(35) - N(32) \approx N(32) + 2(35 - 32) - N(32) = 6$$

18 p

157. On an online exam, a student uses logarithmic differentiation to find the first derivative of

$$f(x) = (3 + \sin(x))^{2+x^2}$$

They type the following two lines for their work.

$$y = (3 + \sin(x))^{2+x^2}$$

$$\ln(y) = \ln(\dots)$$

Unfortunately, the student runs out of time and is unable to submit the rest of their work. Oh no! Find $f'(x)$ by completing the student's work.

Solution

We take logs of both sides, use logarithm laws, and then use implicit differentiation.

$$y = (3 + \sin(x))^{2+x^2}$$

$$\ln(y) = \ln\left((3 + \sin(x))^{2+x^2}\right)$$

$$\ln(y) = (2 + x^2) \ln(3 + \sin(x))$$

$$\frac{1}{y} \cdot \frac{dy}{dx} = 2x \cdot \ln(3 + \sin(x)) + (2 + x^2) \cdot \frac{1}{3 + \sin(x)} \cdot \cos(x)$$

Now solve for $\frac{dy}{dx}$ and replace y with $f(x)$.

$$f'(x) = (3 + \sin(x))^{2+x^2} \cdot \left(2x \ln(3 + \sin(x)) + \frac{(2 + x^2) \cos(x)}{3 + \sin(x)}\right)$$

Midterm Exam #5

16 p

158. Suppose $f(x)$ is continuous on $[0, 10]$. The figure below shows the graph of $y = f'(x)$ on $[0, 10]$.
Note: The figure does not show a graph of $f(x)$ but rather its derivative.)

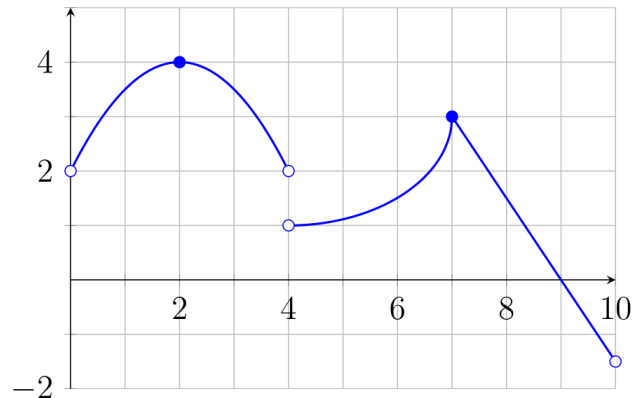

Use the graph to answer the following questions. Read each question carefully. Some questions ask about f and others ask about the derivative f' .

- Find the absolute maximum of $f'(x)$ on $(0, 10)$ or determine that it does not exist.
- Find the absolute minimum of $f'(x)$ on $(0, 10)$ or determine that it does not exist.
- Find all critical points of $f(x)$ in $(0, 10)$.

Solution

- Since $f'(x)$ takes on the value 4 and no value larger, 4 is the absolute maximum.
- The range of $f'(x)$ is $(10, 4]$, and so there is no absolute minimum.
- The critical points of f are $x = 4$ (because $f'(4)$ does not exist) and $x = 9$ (because $f'(9) = 0$).

14 p

159. Given that x units of a commodity are sold, the marginal cost is

$$\frac{dC}{dx} = 9x^2 + 4x + 15x^{1/4} + 10$$

Suppose the total cost of producing the 1st unit is 100. Calculate the total cost of producing the first 16 units.

Solution

Antidifferentiation gives us the total cost function.

$$C(x) = \int (9x^2 + 4x + 15x^{1/4} + 10) dx = 3x^3 + 2x^2 + 12x^{5/4} + 10x + K$$

We are given that $C(1) = 100$, whence $3 + 2 + 12 + 10 + K = 100$, and so $K = 73$. So then the total cost of producing 16 units is

$$C(16) = (3x^3 + 2x^2 + 12x^{5/4} + 10x + 73) \Big|_{x=16} = 13,417$$

18 p

160. Let $f(x) = \frac{1-2x}{6+x^2}$. Find the absolute extrema of f on $[-3, 2]$ and where they occur.

Solution

The function f is differentiable for all x , and so the only critical points are solutions to $f'(x) = 0$. We have

$$f'(x) = \frac{(-2)(6+x^2) - 2x(1-2x)}{(6+x^2)^2} = \frac{2(x-3)(x+2)}{(6+x^2)^2}$$

Hence the critical points are $x = 3$ (not in the interval $[-3, 2]$) and $x = -2$. We now compare critical and endpoint values:

$$\begin{array}{cccc} x & -3 & -2 & 2 \\ \hline f(x) & \frac{7}{15} & \frac{1}{2} & -\frac{3}{10} \end{array}$$

Hence the absolute maximum is $\frac{1}{2}$ at $x = -2$ and the absolute minimum is $-\frac{3}{10}$ at $x = 2$.

16 p

- 161.** Calculate the limit or show that it does not exist. If the limit is “ $+\infty$ ” or “ $-\infty$ ”, write that as your answer, instead of “does not exist”.

$$\lim_{x \rightarrow 1} \left(\frac{\tan(\pi x)}{\sqrt{2+x^3} - \sqrt{2+x}} \right)$$

Solution

Direct substitution of $x = 1$ gives the indeterminate form “ $\frac{0}{0}$ ”. So we use l’Hospital’s rule.

$$\lim_{x \rightarrow 1} \left(\frac{\tan(\pi x)}{\sqrt{2+x^3} - \sqrt{2+x}} \right) \stackrel{H}{=} \lim_{x \rightarrow 1} \left(\frac{\pi \sec(\pi x)^2}{\frac{3x^2}{2\sqrt{2+x^3}} - \frac{1}{2\sqrt{2+x}}} \right) = \frac{\pi \cdot 1^2}{\frac{3}{2\sqrt{3}} - \frac{1}{2\sqrt{3}}} = \sqrt{3}\pi$$

16 p

- 162.** Let $f(x) = x^{1/3}(x-16)^{1/5}$. Find all critical points of f . You must be clear why each of your answers really is a critical point. **Note:** The domain of f is $(-\infty, \infty)$.

Solution

The first derivative of f is

$$f'(x) = \frac{1}{3}x^{-2/3}(x-16)^{1/5} + x^{1/3} \cdot \frac{1}{5}(x-16)^{-4/5} = \frac{8(x-10)}{15x^{2/3}(x-16)^{4/5}}$$

The critical points of f are where $f'(x)$ does not exist ($x = 0$ and $x = 16$) or where $f'(x) = 0$ ($x = 10$).

20 p

- 163.** Consider the following limit.

$$L = \lim_{x \rightarrow -3} (4+x)^{7/(6+2x)}$$

- What indeterminate form does this limit have?
- Explain why l’Hospital’s rule cannot be used on this limit in its current form.
- Calculate the value of L .

Solution

- (a) Direct substitution of $x = -3$ gives “ $1^{1/0}$ ”, equivalent to the indeterminate form “ 1^∞ ”.
- (b) L’Hospital’s rule cannot be used because the limit is not in the form of a quotient.
- (c) We take logarithms and then use l’Hospital’s rule. Let L be the given limit. Then we have:

$$\begin{aligned}\ln(L) &= \lim_{x \rightarrow -3} \ln \left((4+x)^{7/(6+2x)} \right) = \lim_{x \rightarrow -3} \left(\frac{7}{6+2x} \cdot \ln(4+x) \right) \\ &= \lim_{x \rightarrow -3} \left(\frac{7 \ln(4+x)}{6+2x} \right) = \lim_{x \rightarrow -3} \left(\frac{7 \cdot \frac{1}{4+x}}{2} \right) = \frac{7}{2}\end{aligned}$$

So $\ln(L) = \frac{7}{2}$, whence $L = e^{7/2}$.

Midterm Exam #6

25 p

164. Suppose f is continuous for all x and its first derivative is given by $f'(x) = (x - 4)^2(x + 2)$.

- Where is f decreasing?
- A student writes “since $f'(4) = 0$, there is a local extremum (either min or max) at $x = 4$ ”. Is the student correct? Explain.
- Where is f concave up?
- Find the x -coordinate of each inflection point of f .

Solution

- (a) We calculate a sign chart for the first derivative. The cut points are the solutions to $f'(x) = 0$ ($x = -2$ and $x = 4$) and where $f'(x)$ does not exist (none).

interval	test point	sign of f'	shape of f
$(-\infty, -2)$	$f'(-3)$	$\oplus\ominus = \ominus$	decreasing
$(-2, 4)$	$f'(0)$	$\oplus\oplus = \oplus$	increasing
$(4, \infty)$	$f'(5)$	$\oplus\oplus = \oplus$	increasing

Thus $f(x)$ is decreasing on $(-\infty, -2]$.

- (b) The student is incorrect. In general, the vanishing of the derivative at $x = a$ is not sufficient for there to be a local extremum at $x = a$. There must also be a sign change in the derivative at $x = a$. Indeed, in this case we see that f is increasing on the interval $[-2, \infty)$, whence there is no local extremum at $x = 4$.
- (c) We calculate a sign chart for the second derivative:

$$f''(x) = 2(x - 4) \cdot 1 \cdot (x + 2) + (x - 4)^2 \cdot 1 = 3x(x - 4)$$

The cut points are the solutions to $f''(x) = 0$ ($x = 0$ and $x = 4$) and where $f''(x)$ does not exist (nowhere).

interval	test point	sign of f''	shape of f
$(-\infty, 0)$	$f''(-1)$	$\ominus\ominus = \oplus$	concave up
$(0, 4)$	$f''(1)$	$\oplus\ominus = \ominus$	concave down
$(4, \infty)$	$f''(5)$	$\oplus\oplus = \oplus$	concave up

Thus $f(x)$ is concave up on $(-\infty, 0]$ and $[4, \infty)$.

- (d) There is an inflection point at both $x = 0$ and $x = 4$ (f is continuous and changes concavity at each of these points).

25 p

165. Farmer Brown wants to create a rectangular pen that must enclose exactly 1800 ft². The fencing along the north and south sides of the fence costs \$10/ft and the fencing along the east and west sides costs \$5/ft. (The cost is different because some parts of the fence have to be taller than other parts.) Let x denote the length of the north side and let y denote the length of the east side.

- What are the dimensions and total cost of the cheapest pen?
- Justify that your answer really does give the cheapest pen.

Solution

- (a) The total cost of the fence is $F(x, y) = 20x + 10y$. We wish to maximize F subject to the constraint $xy = 1800$. Hence our objective function is $f(x) = 20x + \frac{18000}{x}$, and our interval of interest is $(0, \infty)$. Observe that

$$f'(x) = 20 - \frac{18000}{x^2}$$

Solving $f'(x) = 0$ gives us the only critical point in our interval: $x = 30$. Hence the optimal dimensions of the fence are $x = 30$ ft and $y = \frac{1800}{30} = 60$ ft. The cost of the cheapest pen is $F(30, 60) = 20 \cdot 30 + 10 \cdot 60 = 1200$ dollars.

- (b) Observe that $f''(x) = \frac{36000}{x^3}$, and so $f''(30) > 0$. Hence by the second derivative test, $x = 30$ gives a local minimum of $f(x)$. Since $x = 30$ is the only critical point of f on $(0, \infty)$, we conclude that this local minimum is also an absolute minimum.

25 p 166. Suppose $f(x)$ satisfies all of the following properties.

- $f(x)$ is continuous and differentiable on $(-\infty, 3) \cup (3, \infty)$
- $x = 3$ is a vertical asymptote of $f(x)$
- $\lim_{x \rightarrow \infty} f(x) = 1$
- the only x -values for which $f'(x) = 0$ are $x = 0$ and $x = 5$
- the only x -values for which $f''(x) = 0$ are $x = 0$ and $x = 7$

A sign chart for the first and second derivatives of f are given below.

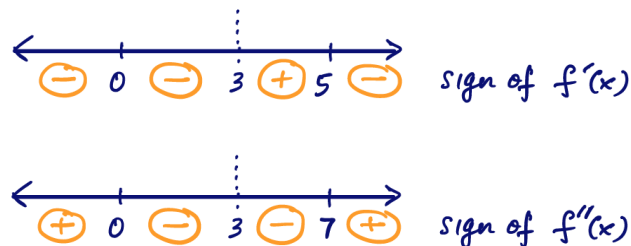

Use this information to answer the following questions about $f(x)$. **Note:** Do not attempt to find an algebraic formula for $f(x)$.

- Where is f increasing?
- Where is f concave down?
- At which x -value(s) does f have a local minimum?
- At which x -value(s) does f have a local maximum?
- Calculate $\lim_{x \rightarrow 3^+} f(x)$ or determine there is not enough information to do so.
- Calculate $\lim_{x \rightarrow -\infty} f(x)$ or determine there is not enough information to do so.
- Sketch a possible graph of $y = f(x)$. Clearly mark and label all of the following: local minima, local maxima, inflection points, vertical asymptotes, horizontal asymptotes. *Your graph does not have to be to scale, but the shape must be correct.*

Solution

- (a) On the sign chart for f' we look for intervals where f' is non-negative. Hence f is increasing on $(3, 5]$.
- (b) On the sign chart for f'' we look for intervals where f'' is non-positive. Hence f is concave down on $[0, 3)$ and $(3, 7]$.
- (c) The first derivative of f never transitions from negative to positive at a point of continuity (f is discontinuous at $x = 3$). So there is no local minimum.
- (d) The first derivative of f transitions from positive to negative at $x = 5$ (and f is continuous there). So there is a local maximum at $x = 5$.
- (e) Since $x = 3$ is a vertical asymptote, we know that $\lim_{x \rightarrow 3^+} f(x)$ is infinite. Since f is increasing on $(3, 5]$, we must have $\lim_{x \rightarrow 3^+} f(x) = -\infty$. (This is also consistent with the negative concavity of f on $(3, 7]$.)
- (f) If $\lim_{x \rightarrow -\infty} f(x) = L$ for some finite L , then there are three possibilities, all of which are inconsistent with the given information:
- **The graph of f approaches the asymptote $y = L$ from above.** Since f is differentiable this would imply that f would be increasing on an interval of the form $(-\infty, a]$. But f is decreasing on $(-\infty, 0]$.
 - **The graph of f approaches the asymptote $y = L$ from below.** Since f is differentiable this would imply that f would have negative concavity on an interval of the form $(-\infty, a]$. But f is concave up on $(-\infty, 0]$.
 - **The graph of f oscillates about the asymptote $y = L$.** Since f is differentiable, this would imply that f would have infinitely many local extrema in the interval $(-\infty, 0]$. But the only local extremum is at $x = 5$.

Since f is decreasing on $(-\infty, 0]$, it is also not possible that $\lim_{x \rightarrow -\infty} f(x) = -\infty$. Thus the only possibility left that is consistent with all of the given information is $\lim_{x \rightarrow -\infty} f(x) = \infty$.

- (g) One possibility is shown below.

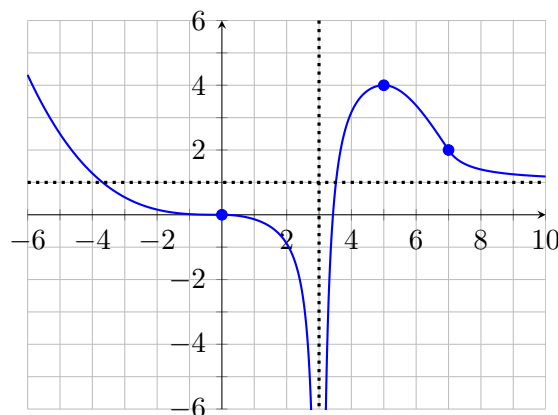

25 p

167. In a certain video game, the player may adjust the values of their character's *Intelligence* (denoted by x) and *Dexterity* (denoted by y). These power values must be non-negative but can be any real number (they need not be whole numbers). The player cannot arbitrarily adjust their power, but rather these values must satisfy the equation $x^2 + y^2 = 100$. The total damage done (denoted by D) by the spell *Thunderbolt* is given by $D = x + 3y$.

- (a) How should the player adjust their power so that *Thunderbolt* does the most possible damage?
- (b) What is the minimum possible damage that *Thunderbolt* will do, regardless of how the player adjusts their character's power? How should a player adjust these power values to achieve the minimum possible damage?

Solution

- (a) We seek to maximize the function $D(x, y) = x + 3y$ subject to the constraint $x^2 + y^2 = 100$ (with x and y non-negative). Solving for y in terms of x gives $y = \sqrt{100 - x^2}$, whence our objective function is

$$f(x) = x + 3\sqrt{100 - x^2}$$

and our interval of interest is $[0, 10]$. Observe that

$$f'(x) = 1 - \frac{3x}{\sqrt{100 - x^2}}$$

Solving $f'(x) = 0$ gives us the only critical point in our interval: $x = \sqrt{10}$.

The extreme values of f must occur at a critical point or an endpoint of $[0, 10]$.

x	0	$\sqrt{10}$	10
$f(x)$	30	$10\sqrt{10}$	10

(Note that $10\sqrt{10} \approx 31$.) Hence $x\sqrt{10}$ gives the maximum possible value of f , corresponding to *Intelligence* of $\sqrt{10}$ and *Dexterity* of $y = \sqrt{100 - x^2} = 3\sqrt{10}$.

- (b) From our previous work, we see that the absolute minimum of D is 10, occurring when $x = 10$ (and $y = 0$).

Midterm Exam #7

20 p

168. Let $f(x) = 5 + \int_{-3}^x t^2 e^t dt$. Find an equation of the tangent line to f at $x = -3$.

Solution

Note that $f(-3) = 5 + 0 = 5$ and, by the fundamental theorem of calculus, $f'(x) = x^2 e^x$. Hence $f'(-3) = 9e^{-3}$, and an equation of our tangent line is

$$y = 5 + 9e^{-3}(x + 3)$$

20 p

169. Suppose f is continuous on $[0, 8]$ and has the following integrals:

$$\int_0^3 f(x) dx = 2 \qquad \int_3^5 f(x) dx = 7 \qquad \int_0^8 f(x) dx = 15$$

For each part, calculate the integral or determine there is not enough information to do so.

(a) $\int_0^5 f(x) dx$ (b) $\int_5^3 f(x) dx$ (c) $\int_5^8 f(x) dx$ (d) $\int_3^8 (2f(x) - 6) dx$

Solution

(a) $\int_0^5 f(x) dx = \int_0^3 f(x) dx + \int_3^5 f(x) dx = 2 + 7 = 9$

(b) $\int_5^3 f(x) dx = -\int_3^5 f(x) dx = -7$

(c) $\int_5^8 f(x) dx = \int_0^8 f(x) dx - \int_0^5 f(x) dx = 15 - 9 = 6$

(d) First observe:

$$\int_3^8 (2f(x) - 6) dx = 2 \cdot \int_3^8 f(x) dx - \int_3^8 6 dx$$

For the second integral on the right side, we note that it gives the area of a rectangle with length $8 - 3 = 5$ and height 6. Hence

$$\int_3^8 6 dx = 5 \cdot 6 = 30$$

For the other integral, we have the following:

$$\int_3^8 f(x) dx = \int_0^8 f(x) dx - \int_0^3 f(x) dx = 15 - 2 = 13$$

Putting this altogether gives us our final answer:

$$\int_3^8 (2f(x) - 6) dx = 2 \cdot \int_3^8 f(x) dx - \int_3^8 6 dx = 2 \cdot 13 - 30 = -4$$

20 p

170. Calculate $\int_0^{\sqrt{10}} (x + \sqrt{10 - x^2}) dx$ using geometry and properties of integrals only. Do not attempt to use the fundamental theorem of calculus.

Solution

First we split the integral into two separate integrals.

$$\int_0^{\sqrt{10}} (x + \sqrt{10 - x^2}) dx = \underbrace{\int_0^{\sqrt{10}} x dx}_A + \underbrace{\int_0^{\sqrt{10}} \sqrt{10 - x^2} dx}_B$$

Now we use geometry to calculate A and B .

Integral A gives the area under the graph of $y = x$ from $x = 0$ to $x = \sqrt{10}$. This region is a triangle with base $\sqrt{10}$ and height $\sqrt{10}$. Thus $A = \frac{1}{2} \cdot \sqrt{10} \cdot \sqrt{10} = 5$.

Integral B gives the area under the graph of $y = \sqrt{10 - x^2}$ from $x = 0$ to $x = \sqrt{10}$. This region is a quarter-disc with center $(0, 0)$ and radius $\sqrt{10}$. Thus $B = \frac{1}{4}\pi \cdot (\sqrt{10})^2 = 25\pi$.

Hence altogether our desired integral is

$$\int_0^{\sqrt{10}} (x + \sqrt{10 - x^2}) dx = 5 + 25\pi$$

- 20 p** 171. The curve $y = 25 - x^2$ is shown in the figure below. Calculate the area of the shaded region.

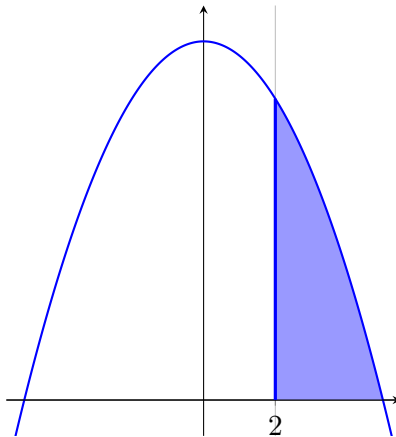
**Solution**

The graph crosses the x -axis where $25 - x^2 = 0$, or at $x = -5$ and $x = 5$. Hence we seek the area under the graph of $y = 25 - x^2$ from $x = 2$ to $x = 5$. That area is given by an integral, which is calculated using the fundamental theorem of calculus below.

$$\int_2^5 (25 - x^2) dx = \left(25x - \frac{1}{3}x^3\right) \Big|_2^5 = \left(125 - \frac{1}{3} \cdot 125\right) - \left(50 - \frac{8}{3}\right) = 36$$

- 20 p** 172. Find the unique positive value of a such that $\int_0^a \frac{x}{x^2 + 1} dx = 3$.

Solution

We use substitution rule with $u = x^2 + 1$ to calculate the integral. Note that with this choice of u , we have $\frac{du}{dx} = 2x$, or $dx = \frac{du}{2x}$. The limits of integration change from $x = 0$ and $x = a$ to $u = 1$

and $u = a^2 + 1$, respectively. Hence we have the following:

$$\int_0^a \frac{x}{x^2+1} dx = \int_1^{a^2+1} \frac{1}{2u} du = \frac{1}{2} \ln(u) \Big|_1^{a^2+1} = \frac{1}{2} \ln(a^2+1) - 0 = \frac{1}{2} \ln(a^2+1)$$

We now solve the equation $\frac{1}{2} \ln(a^2+1) = 3$ to find that $a = \sqrt{e^6 - 1}$ (we have kept only the positive root).

1.8 Fall 2020

Midterm Exam #1A

12 p

173. Fully simplify the difference quotient $\frac{f(x+h) - f(x)}{h}$ for $f(x) = \sqrt{x+2}$ and $h \neq 0$. Write your answer without square roots or fractional exponents in the numerator.

Solution

We have the following.

$$\begin{aligned} \frac{f(x+h) - f(x)}{h} &= \frac{\sqrt{x+h+2} - \sqrt{x+2}}{h} = \frac{(x+h+2) - (x+2)}{h(\sqrt{x+h+2} + \sqrt{x+2})} \\ &= \frac{h}{h(\sqrt{x+h+2} + \sqrt{x+2})} = \frac{1}{\sqrt{x+h+2} + \sqrt{x+2}} \end{aligned}$$

24 p

174. For each part, calculate the limit or show that it does not exist. If the limit is “ $+\infty$ ” or “ $-\infty$ ”, write that as your answer, instead of “does not exist”.

(a) $\lim_{x \rightarrow 5} \left(\frac{25 - x^2}{x - 5} \right)$

(b) $\lim_{x \rightarrow 4} \left(\frac{\frac{1}{x} - \frac{1}{4}}{4 - x} \right)$

Solution

(a) Factor and cancel.

$$\lim_{x \rightarrow 5} \left(\frac{25 - x^2}{x - 5} \right) = \lim_{x \rightarrow 5} \left(\frac{(5-x)(5+x)}{x-5} \right) = \lim_{x \rightarrow 5} (-(5+x)) = -10$$

(b) Simplify, factor, and cancel.

$$\lim_{x \rightarrow 4} \left(\frac{\frac{1}{x} - \frac{1}{4}}{4 - x} \right) = \lim_{x \rightarrow 4} \left(\frac{4 - x}{4x(4 - x)} \right) = \lim_{x \rightarrow 4} \left(\frac{1}{4x} \right) = \frac{1}{16}$$

12 p

175. For each part, use the graph of $y = g(x)$ below.

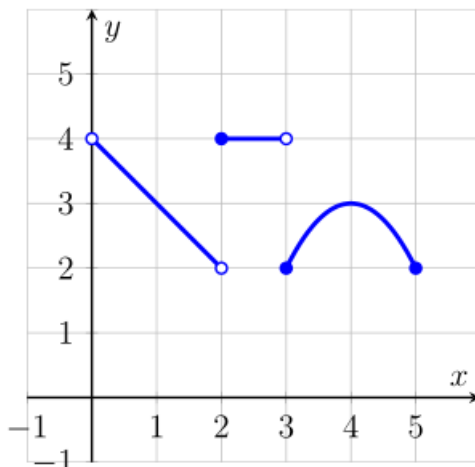

- (a) Find the domain of $g(x)$. Write your answer in interval notation.

(b) Calculate $g(g(4))$.

(c) As $x \rightarrow 2$, which of the left-sided and right-sided limits of $g(x)$ exist?

Solution

(a) The domain is the set of allowed x -values for $g(x)$. Hence the domain is $(0, 5]$.

(b) $g(g(4)) = g(3) = 2$.

(c) Both the left-sided and right-sided limits of $g(x)$ exist as $x \rightarrow 2$.

10 p

176. A student is asked to solve a certain limit and determines the limit does not exist. (This may or may not be the correct answer.) They write the following for their justification:

“I used the direct substitution property to evaluate the limit. I noticed the denominator gives me a zero, therefore the limit does not exist.”

Explain why the student’s justification is incorrect.

Note: To solve this problem, it is not necessary to be given the actual limit the student was asked to compute.

Solution

If direct substitution property gives “ $\frac{0}{0}$ ” this only means that the limit cannot be computed by direct substitution (since $\frac{0}{0}$ is undefined); this does not necessarily mean that the limit does not exist.

Additionally, we also know that there are many limits which arise in this manner that actually do exist. For example, the limit $\lim_{x \rightarrow 0} \left(\frac{x}{x}\right)$ gives “ $\frac{0}{0}$ ” upon direct substitution of $x = 0$, but this limit exists and is equal to 1.

12 p

177. Determine whether $\lim_{x \rightarrow 0} f(x)$ exists, where $f(x) = \begin{cases} 3e^x - 7 & x < 0 \\ 4 + \sin(x) & x \geq 0 \end{cases}$.

Solution

We examine the one-sided limits at $x = 0$.

$$\lim_{x \rightarrow 0^-} f(x) = \lim_{x \rightarrow 0^-} (3e^x - 7) = 3 - 7 = -4$$

$$\lim_{x \rightarrow 0^+} f(x) = \lim_{x \rightarrow 0^+} (4 + \sin(x)) = 4 + 0 = 4$$

Since the left- and right-limits are not equal, $\lim_{x \rightarrow 0} f(x)$ does not exist.

12 p

178. A student is asked to calculate the following limit:

$$L = \lim_{x \rightarrow 0} \left(\frac{x \cos x}{\sin(3x)} \right)$$

Analyze their work below, which contains two distinct errors. **Note:** The correct answer is $\frac{1}{3}$, not 0.

$$L = \lim_{x \rightarrow 0} \left(\frac{x \cos(x)}{3 \sin(x)} \right) \quad (1)$$

$$= \left[\lim_{x \rightarrow 0} \left(\frac{1}{3} \right) \right] \left[\lim_{x \rightarrow 0} \left(\frac{x}{\sin(x)} \right) \right] \left[\lim_{x \rightarrow 0} (\cos(x)) \right] \quad (2)$$

$$= \left(\frac{1}{3} \right) (1)(0) \quad (3)$$

$$= 0 \quad (4)$$

Identify the lines in which the two errors occur and describe each error.

Solution

Line (1) has an error: in general, $\sin(3x) \neq 3 \sin(x)$. (These quantities are equal for some but not all values of x . In particular, $\sin(3x) \neq 3 \sin(x)$ for x close to 0 but not equal to 0.)

Line (3) has an error: $\lim_{x \rightarrow 0} \cos(x) \neq 0$. (By direct substitution property, this limit is 1.)

18 p

179. While solving the logarithmic equation

$$\log_2(3x + 1) = 3$$

a student wrote the following steps (this work contains two distinct errors):

$$\log_2(3x) + \log_2(1) = 3 \quad (1)$$

$$\log_2(3x) + 0 = 3 \quad (2)$$

$$3x = 3^2 \quad (3)$$

$$x = 3 \quad (4)$$

(a) Identify the lines in which the two errors occur and describe each error.

(b) What is the correct solution to the original equation?

Solution

(a) Line (1) has an error: logarithms do not distribute over sums. That is, $\log_a(x + y) \neq \log_a(x) + \log_a(y)$ in general.

Line (3) has an error: the right side should be 2^3 instead of 3^2 since $\log_b(y) = x$ is equivalent to $y = b^x$.

(b) Exponentiating the equation $\log_2(3x + 1) = 3$ immediately gives $3x + 1 = 2^3 = 8$. Then solving for x gives $x = \frac{7}{3}$.

Midterm Exam #1B

14 p 180. Sketch the graph of a function $f(x)$ with all of the given properties. Do not attempt to find a formula for the function.

- (i) $f(1) = 0$ and $\lim_{x \rightarrow 1} f(x)$ does not exist
 (ii) $f(2) = 1$ and $\lim_{x \rightarrow 2} f(x) = 0$
 (iii) $f(3) = -2$ and $\lim_{x \rightarrow 3^-} f(x) = -1$ and $\lim_{x \rightarrow 3^+} f(x) = -2$

Solution

Here is one possibility.

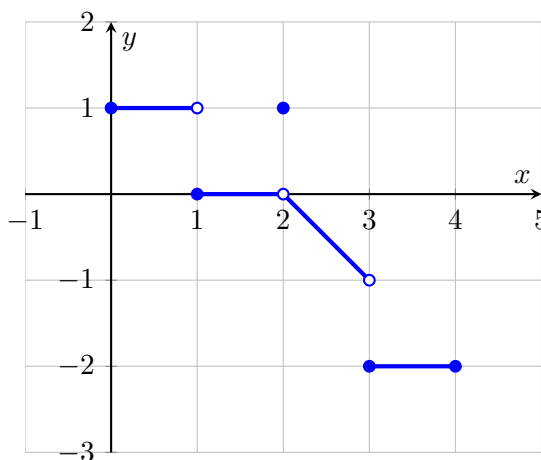

14 p 181. Fully simplify the difference quotient $\frac{f(3+h) - f(3)}{h}$ for $f(x) = \frac{6}{9-2x}$ and $h \neq 0$. Your answer cannot contain a complex fraction (fraction within a fraction).

Solution

We have the following.

$$\frac{f(3+h) - f(3)}{h} = \frac{\frac{6}{9-2(3+h)} - 2}{h} = \frac{\frac{6}{3-2h} - 2}{h} = \frac{6 - 2(3-2h)}{h(3-2h)} = \frac{4h}{h(3-2h)} = \frac{4}{3-2h}$$

182. Consider the function $f(x)$ below, where $g(x)$ is an unspecified function with domain $[4, \infty)$.

$$f(x) = \begin{cases} 4 & x \leq 0 \\ \frac{x-4}{\frac{1}{4} - \frac{1}{x}} & 0 < x < 4 \\ 16 & x = 4 \\ g(x) & x > 4 \end{cases}$$

12 p (a) Show that $\lim_{x \rightarrow 4^-} f(x) = f(4)$.

4 p (b) Suppose $g(4) = 16$. Is it necessarily true that $\lim_{x \rightarrow 4} f(x)$ exists? Justify your response.

Solution

(a) Use the “second piece” of f to compute the limit.

$$\lim_{x \rightarrow 4^-} \left(\frac{x-4}{\frac{1}{4} - \frac{1}{x}} \right) = \lim_{x \rightarrow 4^-} \left(\frac{4x(x-4)}{x-4} \right) = \lim_{x \rightarrow 4^-} (4x) = 4 \cdot 4 = 16$$

Since $f(4) = 16$, we have shown the desired statement.

(b) No. For instance, let g be the following function:

$$g(x) = \begin{cases} 16 & x = 4 \\ 0 & x > 4 \end{cases}$$

Then $g(4) = 16$, but $\lim_{x \rightarrow 4} f(x)$ does not exist because $\lim_{x \rightarrow 4^+} f(x) = \lim_{x \rightarrow 4^+} g(x) = 0$, which is not equal to $\lim_{x \rightarrow 4^-} f(x) = 16$.

The main issue here is that we really need the right limit, not the function value, of g at $x = 4$ to be equal to 16.

8 p

183. A student is asked to solve a certain limit and determines the limit does not exist. (This may or may not be the correct answer.) They write the following for their justification:

“I used the direct substitution property to evaluate the limit. I obtained the expression “ $\frac{0}{0}$ ”, which is undefined. Therefore the limit does not exist.”

Is the student’s justification correct? Explain.

Note: To solve this problem, it is not necessary to be given the actual limit the student was asked to compute.

Solution

If direct substitution property gives “ $\frac{0}{0}$ ” this only means that the limit cannot be computed by direct substitution (since $\frac{0}{0}$ is undefined); this does not necessarily mean that the limit does not exist.

Additionally, we also know that there are many limits which arise in this manner that actually do exist. For example, the limit $\lim_{x \rightarrow 0} \left(\frac{x}{x} \right)$ gives “ $\frac{0}{0}$ ” upon direct substitution of $x = 0$, but this limit exists and is equal to 1.

184. Consider the limit $\lim_{x \rightarrow 3} \left(\frac{(5x-c)(x+4)}{x-3} \right)$, where c is an unspecified constant.

(a) For what value(s) of c does this limit exist? Explain.

(b) Suppose the limit exists. What is its value? Show all work.

Solution

(a) Since direct substitution of $x = 3$ gives 0 in the denominator, the only hope we have of this limit existing is if we get cancellation. That is, there must be a common factor in numerator and denominator to cancel. (Alternatively, we must have a “ $\frac{0}{0}$ ” form upon substitution of $x = 3$.) This means that the numerator must be 0 if $x = 3$.

$$0 = (5 \cdot 3 - c)(3 + 4) = (15 - c) \cdot 7 \implies c = 15$$

10 p**6 p**

(b) If the limit exists, then we must have $c = 15$, in which case we have:

$$\lim_{x \rightarrow 3} \left(\frac{(5x - 15)(x + 4)}{x - 3} \right) = \lim_{x \rightarrow 3} \left(\frac{5(x - 3)(x + 4)}{x - 3} \right) = \lim_{x \rightarrow 3} (5(x + 4)) = 35$$

16 p 185. Suppose we have all of the following:

$$\log_3(x) = A \quad , \quad \log_3(y) = B \quad , \quad \log_{b^5}(z) = C$$

Write each of the following in terms of A , B , and C . Your final answer cannot contain any “log” symbol.

(a) $\log_3 \left(\frac{\sqrt{x}}{9y^4} \right)$

(b) $\log_b(z)$

Solution

(a) We use basic properties of logarithms.

$$\log_3 \left(\frac{\sqrt{x}}{9y^4} \right) = \log_3(\sqrt{x}) - \log_3(9) - \log_3(y^4) = \frac{1}{2} \log_3(x) - 2 - 4 \log_3(y) = \frac{1}{2}A - 2 - 4B$$

(b) By definition of the logarithm, we have:

$$\log_{b^5}(z) = C \iff z = (b^5)^C$$

Hence $z = b^{5C}$. Now taking the log (base b) of both sides gives $\log_b(z) = 5C$.

16 p 186. For each part, use the graph of $y = g(x)$ below.

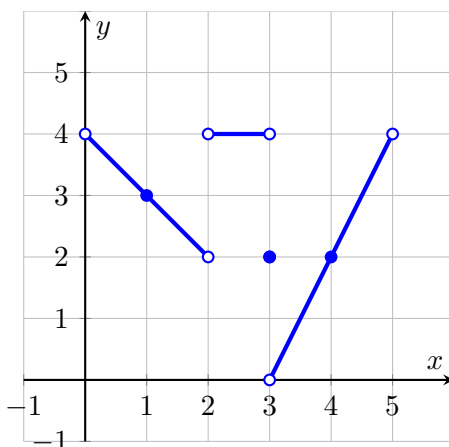

(a) Calculate $g(g(1.5))$.

(b) Find the range of $g(x)$. Write your answer in interval notation.

Solution

(a) $g(g(1.5)) = g(2.5) = 4$.

(b) The range is the set of values of $g(x)$ (i.e., the y -values). Hence the range is $(0, 4]$.

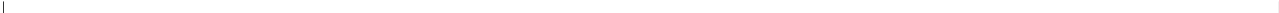

Midterm Exam #2

16 p

187. Calculate all horizontal asymptotes of the function $h(x) = \frac{\sqrt{3x^2 + x + 10}}{2 - 5x}$.

Solution

For $x \neq 0$, we have the following algebra:

$$\frac{\sqrt{3x^2 + x + 10}}{2 - 5x} = \frac{\sqrt{x^2} \sqrt{3 + \frac{1}{x} + \frac{10}{x^2}}}{x \left(\frac{2}{x} - 5\right)} = \frac{|x|}{x} \cdot \frac{\sqrt{3 + \frac{1}{x} + \frac{10}{x^2}}}{\frac{2}{x} - 5}$$

We have used the identity $\sqrt{x^2} = |x|$. To compute the horizontal asymptotes, we compute the limits of h at infinity. For $x \rightarrow \infty$, we may assume that $x > 0$, and so $|x| = x$.

$$\begin{aligned} \lim_{x \rightarrow \infty} h(x) &= \lim_{x \rightarrow \infty} \left(\frac{|x|}{x} \cdot \frac{\sqrt{3 + \frac{1}{x} + \frac{10}{x^2}}}{\frac{2}{x} - 5} \right) = \lim_{x \rightarrow \infty} \left(\frac{x}{x} \cdot \frac{\sqrt{3 + \frac{1}{x} + \frac{10}{x^2}}}{\frac{2}{x} - 5} \right) \\ &= \lim_{x \rightarrow \infty} \left(\frac{\sqrt{3 + \frac{1}{x} + \frac{10}{x^2}}}{\frac{2}{x} - 5} \right) = \frac{\sqrt{3 + 0 + 0}}{0 - 5} = -\frac{\sqrt{3}}{5} \end{aligned}$$

For $x \rightarrow -\infty$, we may assume that $x < 0$, and so $|x| = -x$.

$$\begin{aligned} \lim_{x \rightarrow \infty} h(x) &= \lim_{x \rightarrow \infty} \left(\frac{|x|}{x} \cdot \frac{\sqrt{3 + \frac{1}{x} + \frac{10}{x^2}}}{\frac{2}{x} - 5} \right) = \lim_{x \rightarrow \infty} \left(\frac{-x}{x} \cdot \frac{\sqrt{3 + \frac{1}{x} + \frac{10}{x^2}}}{\frac{2}{x} - 5} \right) \\ &= \lim_{x \rightarrow \infty} \left(-\frac{\sqrt{3 + \frac{1}{x} + \frac{10}{x^2}}}{\frac{2}{x} - 5} \right) = \frac{-\sqrt{3 + 0 + 0}}{0 - 5} = \frac{\sqrt{3}}{5} \end{aligned}$$

Hence the two horizontal asymptotes are $y = -\frac{\sqrt{3}}{5}$ (as $x \rightarrow \infty$) and $y = \frac{\sqrt{3}}{5}$ (as $x \rightarrow -\infty$).

16 p

188. Determine where the following function is continuous. *In your work, you must use limit-based methods to solve this problem. Solutions that have work that is not based on limits will not receive full credit.*

$$f(x) = \begin{cases} \frac{x^2 - 9}{x - 3} & x < 3 \\ 0 & x = 3 \\ 5x - 9 & 3 < x < 4 \\ 11 & x = 4 \\ 27 - x^2 & x > 4 \end{cases}$$

Solution

Each piece of f is a rational function (actually, a polynomial) on their respective domains. So each piece is continuous. Hence we need only check continuity at $x = 3$ and $x = 4$. For $x = 3$, we have the following:

$$\lim_{x \rightarrow 3^+} f(x) = \lim_{x \rightarrow 3^+} (5x - 9) = 6 \quad , \quad f(3) = 0$$

Since the right-limit and function value are not equal at $x = 3$, f is not continuous at $x = 3$. (Note: we don't even have to consider the left-limit here. However, the left-limit is 6.) For $x = 4$, we have the following:

$$\lim_{x \rightarrow 4^-} f(x) = \lim_{x \rightarrow 4^-} (5x - 9) = 11 \quad , \quad \lim_{x \rightarrow 4^+} f(x) = \lim_{x \rightarrow 4^+} (27 - x^2) = 11 \quad , \quad f(4) = 11$$

Since the left-limit, right-limit, and function value at $x = 4$ are all equal, f is continuous at $x = 4$. Hence f is continuous on $(-\infty, 3) \cup (3, \infty)$.

189. Consider the function f below, where A , B , and C are unspecified constants.

$$f(x) = \begin{cases} 2x^3 + Ax & x < -1 \\ C & x = -1 \\ Bx^2 + 4 & x > -1 \end{cases}$$

2 p

(a) Calculate $\lim_{x \rightarrow -1^-} f(x)$.

2 p

(b) Calculate $\lim_{x \rightarrow -1^+} f(x)$.

2 p

(c) How must A and B be related if $\lim_{x \rightarrow -1} f(x)$ exists?

8 p

(d) Suppose $C = 10$ and f is continuous for all x . Find the values of A and B .

Solution

(a) $\lim_{x \rightarrow -1^-} f(x) = \lim_{x \rightarrow -1^-} (2x^3 + Ax) = -2 - A$

(b) $\lim_{x \rightarrow -1^+} f(x) = \lim_{x \rightarrow -1^+} (Bx^2 + 4) = B + 4$

(c) The left- and right-limits must be equal, so we must have that $-2 - A = B + 4$.

(d) To have continuity at $x = -1$, we must have the left-limit, right-limit, and function value all equal. That is, we must have

$$-2 - A = B + 4 = 10$$

Solving for A and B then gives $A = -12$ and $B = 6$.

24 p

190. Consider the function $f(x) = \frac{(ax - 6)(x + 1)}{x - 2}$, where a is an unspecified constant.

(a) For which value(s) of a does f have a vertical asymptote? What is the equation of this vertical asymptote?

(b) For which value(s) of a does f have a horizontal asymptote? What is the equation of this horizontal asymptote?

Solution

(a) *The function f has a vertical asymptote if and only if $a \neq 3$. The vertical asymptote is $x = 2$. Proof below.*

The function f has a vertical asymptote at $x = 2$ (where denominator is 0), as long as the denominator is not also a factor of the numerator. (Recall that if this happens, then the common factors would cancel and we would have a removable discontinuity, not a vertical

asymptote.) Hence the numerator of f must be nonzero if we substitute $x = 2$.

$$(2a - 6)(2 + 1) \neq 0 \implies a \neq 3$$

So f has a vertical asymptote at $x = 2$ if and only if $a \neq 3$.

- (b) *The function f has a horizontal asymptote if and only if $a = 0$. The horizontal asymptote is $y = -6$. Proof below.*

If $a \neq 0$, we have the following:

$$\lim_{x \rightarrow \pm\infty} f(x) = \lim_{x \rightarrow \pm\infty} \left(\frac{x^2}{x} \cdot \frac{(a - \frac{6}{x})(1 + \frac{1}{x})}{1 - \frac{2}{x}} \right) = \lim_{x \rightarrow \pm\infty} (x) \cdot \frac{(a - 0)(1 + 0)}{1 - 0} = \pm\infty \cdot a = \pm\infty$$

(or the signs are reversed if $a < 0$). So there is no horizontal asymptote if $a \neq 0$. Also note that if $a \neq 0$, the numerator of f has degree 2 and the denominator of f has degree 1. From precalculus, you may have learned that this implies f has no horizontal asymptote.

However, if $a = 0$, then we have

$$\lim_{x \rightarrow \pm\infty} f(x) = \lim_{x \rightarrow \pm\infty} \left(\frac{-6(x + 1)}{x - 2} \right) = -6$$

So there is a horizontal asymptote at $y = -6$. (Note that in the case $a = 0$, the numerator and denominator both have degree 1, whence there must be a horizontal asymptote.)

10 p

191. For which value(s) of n , if any, is the following statement true: $\lim_{x \rightarrow 2^-} (2 - x)^n = +\infty$? Explain your answer.

Solution

The statement is true if and only if $n > 0$.

If $n > 0$, then $\lim_{x \rightarrow 2^-} (2 - x)^n = 0$ by direct substitution property. If $n = 0$, then $\lim_{x \rightarrow 2^-} (2 - x)^n = 1$ since $(2 - x)^0 = 1$ for any $x \neq 2$. If $n < 0$, then $n = -m$ for some positive m . So we can equivalently examine the limit:

$$\lim_{x \rightarrow 2^-} \left(\frac{1}{(2 - x)^m} \right)$$

If $x \rightarrow 2^-$, then this means x is close to 2 and $x < 2$, whence $(2 - x)^m$ has limit 0 as $x \rightarrow 2^-$ but remains positive. Hence the limit above is $+\infty$.

10 p

192. Suppose the line $y = 3$ is a horizontal asymptote for f . Which of the following statements MUST be true? Select all that apply.

- (a) $f(x) \neq 3$ for all x in the domain of f (d) $\lim_{x \rightarrow \infty} f(x) = 3$
 (b) $f(3)$ is undefined
 (c) $\lim_{x \rightarrow 3} f(x) = \infty$ (e) none of the above

Solution

Choice (e) only.

For choices (a), (b), and (c), consider $f(x) = 3$ (constant function). Then f has a horizontal asymptote at $y = 3$, but none of (a), (b), and (c) is true.

For choice (d), consider $f(x) = e^x + 3$. Then f has a horizontal asymptote at $y = 3$ because $\lim_{x \rightarrow -\infty} f(x) = 3$, but choice (d) is false since $\lim_{x \rightarrow \infty} f(x) = \infty$.
Hence choice (e) must be correct.

10 p

193. Which of the following equations expresses the fact that $f(x)$ is continuous at $x = 6$. (There is only one correct choice.)

(a) $\lim_{x \rightarrow 6} f(6) = f(6)$

(d) $\lim_{x \rightarrow 6} f(x) = 6$

(g) $\lim_{x \rightarrow \infty} f(x) = f(6)$

(b) $\lim_{x \rightarrow 6} f(6) = 6$

(e) $\lim_{x \rightarrow 6} f(x) = 0$

(h) $\lim_{x \rightarrow \infty} f(x) = \infty$

(c) $\lim_{x \rightarrow 6} f(x) = f(6)$

(f) $\lim_{x \rightarrow 6} f(x) = \infty$

Solution

Choice (c). (Definition of continuity.)

Midterm Exam #3

194. Consider the graph of $y = f(x)$ below.

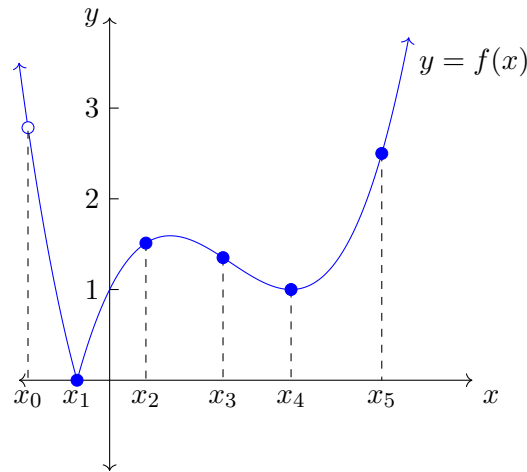

8 p

(a) For which values of x is $f'(x) \geq 0$? Choose from x_0 , x_1 , x_2 , x_3 , x_4 , and x_5 . Select all that apply.

4 p

(b) For which values of x does $f'(x)$ not exist? Choose from x_0 , x_1 , x_2 , x_3 , x_4 , and x_5 . Select all that apply.

8 p

(c) Give a brief, one-sentence explanation of your answer to part (b).

Solution

(a) x_2, x_4, x_5

(b) x_0, x_1

(c) At x_0 , f is not continuous. At x_1 , the graph of f has a sharp corner.

20 p

195. Consider the function $f(x) = x^3 - 6x + c$, where c is an unspecified constant. Suppose the line $102x - y = 609$ is tangent to the graph of $y = f(x)$ at the point P in the first quadrant.

(a) What is the value of $f'(x)$ at the point P ? Give a brief, one-sentence explanation.

(b) Find the x -coordinate of P .

(c) Find the y -coordinate of P .

(d) Find the value of c .

Solution

(a) The slope of the tangent line at P is 102, hence $f'(x) = 102$ at P .

(b) We solve the equation $f'(x) = 102$.

$$3x^2 - 6 = 102 \implies x^2 = 36 \implies x = 6$$

(We reject the solution $x = -6$ since P is in the first quadrant.)

(c) The tangent line and graph of f coincide at the point of tangency. So substituting $x = 6$ into the equation of the tangent line gives $y = 102 \cdot 6 - 609 = 3$.

- (d) We have $f(6) = 6^3 - 6 \cdot 6 + c = 180 + c$. On the other hand, from part (c), $f(6) = 3$. Hence $180 + c = 3$, and so $c = -177$.

- 20 p** 196. Let $f(x) = \frac{8e^x}{x-3}$. Find the equation of each horizontal tangent line of f .

Solution

A horizontal tangent line occurs at points where $f'(x) = 0$.

$$f'(x) = \frac{8e^x(x-3) - 8e^x \cdot 1}{(x-3)^3} = \frac{8e^x(x-4)}{(x-3)^2}$$

Solving $f'(x) = 0$ gives $x = 4$ (whence $f(4) = 8e^4$). Hence the only horizontal tangent line is $y = 8e^4$.

- 20 p** 197. Consider the following limit.

$$\lim_{x \rightarrow \frac{\pi}{8}} \left(\frac{\tan(2x) - 1}{x - \frac{\pi}{8}} \right)$$

- (a) Use the limit definition of derivative to identify this limit as the derivative of some function $f(x)$ at the point $x = a$. You must explicitly identify f and a .
 (b) Use your identifications in part (a) to calculate the given limit. Show all work.

Solution

- (a) The limit definition of derivative is

$$f'(a) = \lim_{x \rightarrow a} \left(\frac{f(x) - f(a)}{x - a} \right)$$

Comparing this to the given limit, we find that $a = \frac{\pi}{8}$ and $f(x) = \tan(2x)$.

- (b) By part (a), the given limit is $f'(\frac{\pi}{8})$. Chain rule gives $f'(x) = 2 \sec(2x)^2$, whence the value of the limit is $f'(\frac{\pi}{8}) = 2 \cdot (\sqrt{2})^2 = 4$.

- 20 p** 198. Suppose $f(1) = -8$ and $f'(1) = 12$. Let $F(x) = x^3 f(x) + 10$. Find an equation of the tangent line to F at $x = 1$.

Solution

Observe that $F(1) = f(1) + 10 = 2$. Hence the point of tangency is $(1, 2)$. Using product rule, we have

$$F'(x) = 3x^2 f(x) + x^3 f'(x)$$

Hence the slope of the tangent line is $F'(1) = 3f(1) + f'(1) = -12$. So the equation of the desired tangent line is

$$y = 2 - 12(x - 1)$$

Midterm Exam #4

- 6 p** 199. Suppose f is differentiable on $(-\infty, \infty)$, $f(5) = 3$, and $f'(5) = -7$. Use linear approximation to estimate $f(5.1)$.

Solution

The tangent line to f at $x = 5$ is $y = 3 - 7(x - 5)$. Hence $f(5.1) \approx 3 - 7(5.1 - 5) = 2.3$.

- 38 p** 200. At a certain moment, a race official is watching a race car approach the finish line along a straight track at some constant, positive speed. Suppose the official is sitting still at the finish line, 20 m from the point where the car will cross.

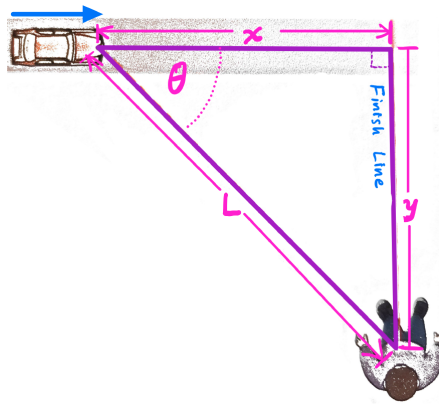

For parts (a)–(e), the allowed answers are “positive”, “negative”, “zero”, or “not enough information”.

- At the moment described, what is the sign of $\frac{dx}{dt}$?
- At the moment described, what is the sign of $\frac{dy}{dt}$?
- At the moment described, what is the sign of $\frac{dL}{dt}$?
- At the moment described, what is the sign of $\frac{d(\cos(\theta))}{dt}$?
- At the moment described, what is the sign of $\frac{d^2x}{dt^2}$?
- Suppose the speed of the car is 70 m/sec. At what rate is the distance between the car and the race official changing when the car is 60 m from the finish line? *Your answer must have the correct units. Your answer must be exact. No decimal approximations.*

Solution

- negative (x is decreasing)
- zero (y is constant)
- negative (L is decreasing)
- negative (θ is increasing to 90-degrees, whence $\cos(\theta)$ is decreasing to 0)
- zero (the speed of the car is constant, whence $\frac{dx}{dt}$ is constant)
- Observe that $x^2 + 400 = L^2$, and so $x \frac{dx}{dt} = L \frac{dL}{dt}$. Substituting $\frac{dx}{dt} = -70$ and $x = 60$ gives the equations:

$$3600 + 400 = L^2 \quad , \quad -4200 = L \frac{dL}{dt}$$

The first equation gives $L = \sqrt{4000}$, whence the second equation gives

$$\frac{dL}{dt} = \frac{-4200}{\sqrt{4000}} = -21\sqrt{10}$$

The distance between the car and the official decreases at a rate of $21\sqrt{10}$ m/sec.

- 24 p** 201. Use linear approximation to estimate $\sqrt[3]{29} - \sqrt[3]{27}$. Your final answer must be exact and may not contain any radicals.

Solution

We use the tangent line to $f(x) = x^{1/3}$ at $x = 27$ to estimate $\sqrt[3]{29}$. Observe that $f(27) = 3$ and $f'(x) = \frac{1}{3}x^{-2/3}$, whence $f'(27) = \frac{1}{27}$. The desired tangent line is thus $y = 3 + \frac{1}{27}(x - 27)$, which gives:

$$\sqrt[3]{29} - \sqrt[3]{27} \approx 3 + \frac{1}{27}(29 - 27) - 3 = \frac{2}{27}$$

- 32 p** 202. Consider the following curve, where a and b are unspecified constants.

$$ax^2y - 3xy^2 + 4x = b$$

- (a) Show that $\frac{dy}{dx} = \frac{3y^2 - 2axy - 4}{ax^2 - 6xy}$.
- (b) Suppose the tangent line to the curve at the point $(1, 1)$ is $y = 1 + 5(x - 1)$. Use part (a) to find the value of a .
- (c) Use your answer to part (b) to find the value of b .

Solution

- (a) Differentiate both sides of the equation with respect to x , using product rule and chain rule on each of the first two terms.

$$2axy + ax^2 \frac{dy}{dx} - 3y^2 - 6xy \frac{dy}{dx} + 4 = 0$$

Collecting like terms and factoring gives:

$$(ax^2 - 6xy) \frac{dy}{dx} + (2axy - 3y^2 + 4) = 0$$

Elementary algebra then gives the desired result.

- (b) The slope of the tangent line at $(1, 1)$ is 5, whence

$$5 = \left. \frac{dy}{dx} \right|_{(x,y)=(1,1)} = \left. \left(\frac{3y^2 - 2axy - 4}{ax^2 - 6xy} \right) \right|_{(x,y)=(1,1)} = \frac{-2a - 1}{a - 6}$$

Solving for a gives $a = \frac{29}{7}$.

- (c) The point $(1, 1)$ lies on the curve, i.e., the point $(1, 1)$ satisfies the original equation. This implies $a + 1 = b$, and so $b = \frac{36}{7}$.

Midterm Exam #5

18 p 203. For each part, use the graph of $y = f(x)$. Assume that the domain of f is $(-\infty, \infty)$.

- (a) Where does f have a local minimum?
 (b) List all of the critical points of f .
 (c) Estimate the absolute maximum of f on $[0, 3]$ or explain why f has no such maximum.

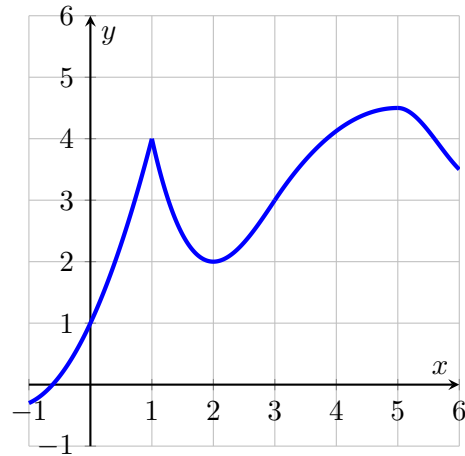
**Solution**

- (a) There is a local minimum at $x = 2$ only.
 (b) The critical points are $x = 1$ (since $f'(1)$ does not exist), $x = 2$ (since $f'(2) = 0$), and $x = 5$ (since $f'(5) = 0$).
 (c) The maximum of $f(x)$ on $[0, 3]$ is $f(1) = 4$.

18 p 204. Consider the limit $\lim_{x \rightarrow 2^-} ((x - 2) \ln(2 - x))$.

- (a) Does this limit have an indeterminate form? If so, which indeterminate form?
 (b) Explain why l'Hospital's rule cannot be used on this limit in its current form.
 (c) Write the limit in an equivalent form to which l'Hospital's rule may be applied.

Note: Do not attempt to calculate the limit. You are not required to calculate the limit.

Solution

- (a) Yes, the form $0 \cdot (-\infty)$.
 (b) The expression is not written as an indeterminate quotient.
 (c) One possibility is $\lim_{x \rightarrow 2^-} \left(\frac{\ln(2 - x)}{\frac{1}{x-2}} \right)$.

20 p 205. Suppose $f'(x)$ is continuous with $f(3) = 2$ and $f'(3) = -8$. Calculate the following limit or show that it does not exist. If the limit is $+\infty$ or $-\infty$, write that as your answer, instead of "does not exist".

$$\lim_{x \rightarrow 1} \left(\frac{2x^4 - f(3x^{1/4})}{x^2 - 4x + 3} \right)$$

Solution

Direct substitution of $x = 1$ gives " $\frac{0}{0}$ ", and so we use l'Hospital's rule, followed by direct substitution.

$$\lim_{x \rightarrow 1} \left(\frac{2x^4 - f(3x^{1/4})}{x^2 - 4x + 3} \right) \stackrel{H}{=} \lim_{x \rightarrow 1} \left(\frac{8x^3 - f'(3x^{1/4}) \cdot \frac{3}{4}x^{-3/4}}{2x - 4} \right) = \frac{8 - (-8) \cdot \frac{3}{4}}{-2} = -7$$

22 p

206. Let $V(t)$ denote the volume of water, measured in gallons, in a tank at time t . The tank is initially filled with 5 gallons of water. At $t = 0$, water flows in at a rate in gal/min given by $V'(t) = 0.5(196 - t^2)$ for $0 \leq t \leq 10$. Find the total amount of water in the tank after 4 minutes.

Solution

Computing the antiderivative of $V'(t)$ immediately gives $V(t) = 0.5(196t - \frac{1}{3}t^3) + C$ for some constant C . The condition $V(0) = 5$ implies $C = 5$, whence $V(t) = 98t - \frac{1}{6}t^3 + 5$. The volume of water in the tank after 4 minutes is $V(4) = \frac{1183}{3}$ gallons.

22 p

207. (You will need a basic calculator for this problem.)

Consider the function

$$f(t) = \frac{a}{t^2 - 3t + 25}$$

where a is an unspecified **positive** constant. Suppose the absolute minimum of f on $[0, 6]$ is 3.

- Find the value of a . **Hint:** First find the absolute minimum of f on $[0, 6]$ in terms of a .
- Calculate the absolute maximum of f on $[0, 6]$.

Solution

- We first find the absolute extrema of f on $[0, 6]$ in terms of a . Since f is differentiable for all t , the only critical points are solutions to $f'(t) = 0$.

$$f'(t) = \frac{a(2t - 3)}{(t^2 - 3t + 25)^2} = 0 \implies t = 1.5$$

We now make a table that includes any critical values and endpoint values. Observe:

$$f(0) = \frac{a}{25} \quad , \quad f(1.5) = \frac{4a}{91} \quad , \quad f(6) = \frac{a}{43}$$

Since a is positive, we see that the largest of these values is $f(1.5)$ and the smallest of these values is $f(6)$. We are given that the absolute minimum is 3, and so $f(6) = \frac{a}{43} = 3$, whence $a = 129$.

- From our previous work, the absolute maximum is $f(1.5) = \frac{4a}{91}$. With $a = 129$, we see that the absolute maximum is $\frac{516}{91}$.

Midterm Exam #6

- 6 p** 208. The figure below shows the graphs of f , f' , and f'' . Identify which graph is that of f'' .

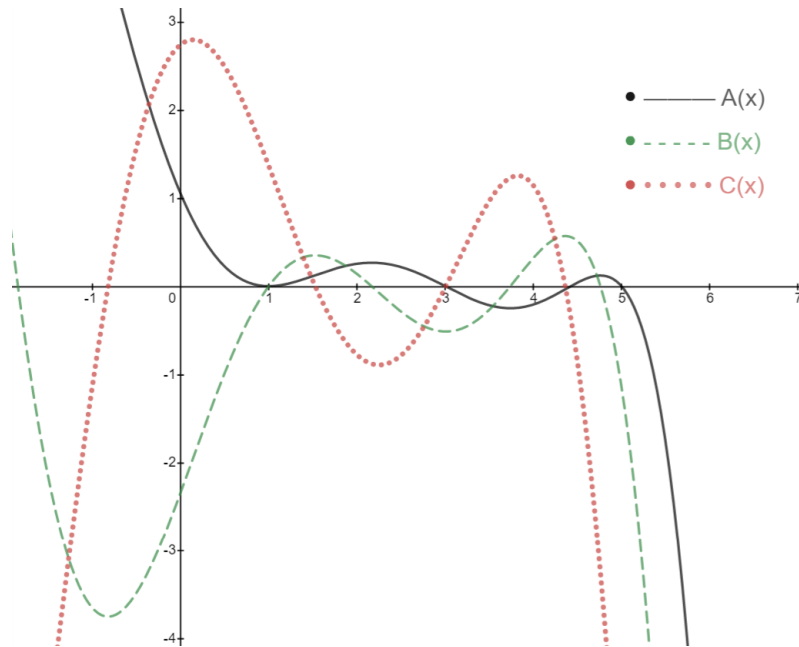
**Solution**

$f''(x) = C(x)$. *Proof below.*

We can see that $A'(x) = B(x)$ and $B'(x) = C(x)$ by observing the locations of relative extrema and zeros. For instance, $B(x)$ has a zero wherever $A(x)$ has a relative extremum, and $C(x)$ has a zero wherever $B(x)$ has a relative extremum. (Strictly speaking, this is not enough to conclude $A'(x) = B(x)$ and $B'(x) = C(x)$. However, we can also observe intervals of increase. For instance, $A(x)$ is decreasing wherever $B(x)$ is negative and $A(x)$ is increasing wherever $B(x)$ is positive. The same observation holds for $B(x)$ and $C(x)$.)

It follows that $A''(x) = C(x)$, and so $f'' = C$.

- 8 p** 209. The figure below shows the graphs of f , f' , and f'' . Identify which graph is which.

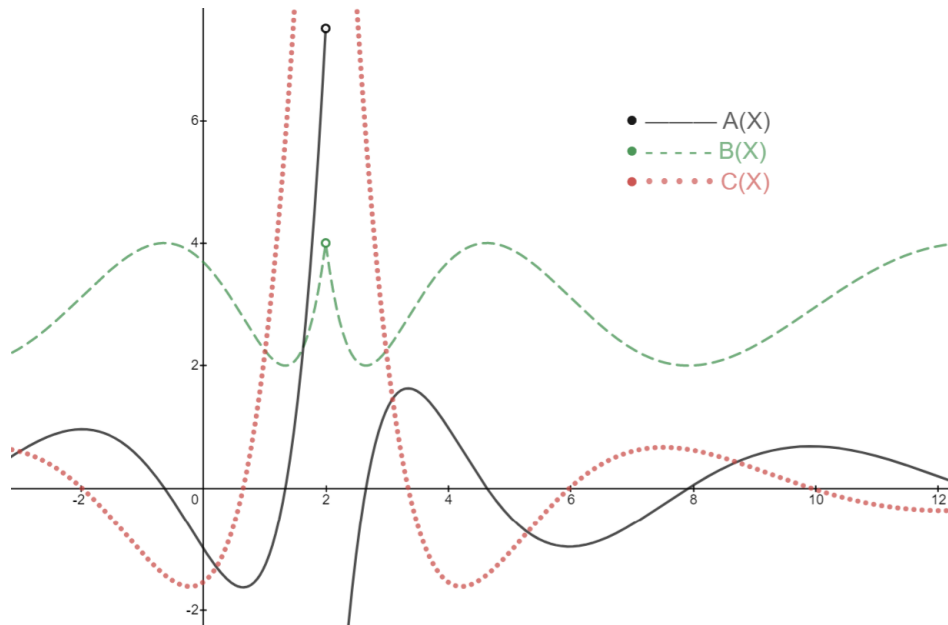

Solution

The only choice for $B(x)$ is $f(x)$ since B has a removable discontinuity at $x = 2$ but $A(x)$ and $C(x)$ do not. Now we simply observe the behavior near $x = 2$. Note that $B(x)$ is increasing on $(2 - \epsilon, 2)$ and decreasing on $(2, 2 + \epsilon)$ for some small $\epsilon > 0$. Hence $B'(x) > 0$ on $(2 - \epsilon, 2)$ and $B'(x) < 0$ on $(2, 2 + \epsilon)$. The only function with these signs is $A(x)$, whence $B'(x) = A(x)$. That leaves only $A'(x) = C(x)$, which we can again verify by a similar argument.

Hence $f = B$, $f' = A$, and $f'' = C$.

24 p

210. Suppose $f(x)$ satisfies all of the following properties. Sketch a possible graph of $y = f(x)$ on the axes provided. Label all asymptotes, local extrema, and inflection points. Your graph need not to be to scale, but it must have the correct shape.

Information from $f(x)$:

- $\lim_{x \rightarrow -\infty} f(x) = 1$
- $\lim_{x \rightarrow \infty} f(x) = 6$
- $x = -3$ is a vertical asymptote for f

Information from $f'(x)$:

- $f'(x) > 0$ on $(2, \infty)$
- $f'(x) < 0$ on $(-\infty, -3)$ and $(-3, 2)$
- $f'(2) = 0$

Information from $f''(x)$:

- $f''(x) > 0$ on $(-3, 5)$
- $f''(x) < 0$ on $(-\infty, -3)$ and $(5, \infty)$
- $f''(5) = 0$

Solution

There is one relative minimum at $x = 2$ and one inflection point at $x = 5$. The lines $y = 1$ and $y = 6$ are both horizontal asymptotes. Here is one possibility for the graph.

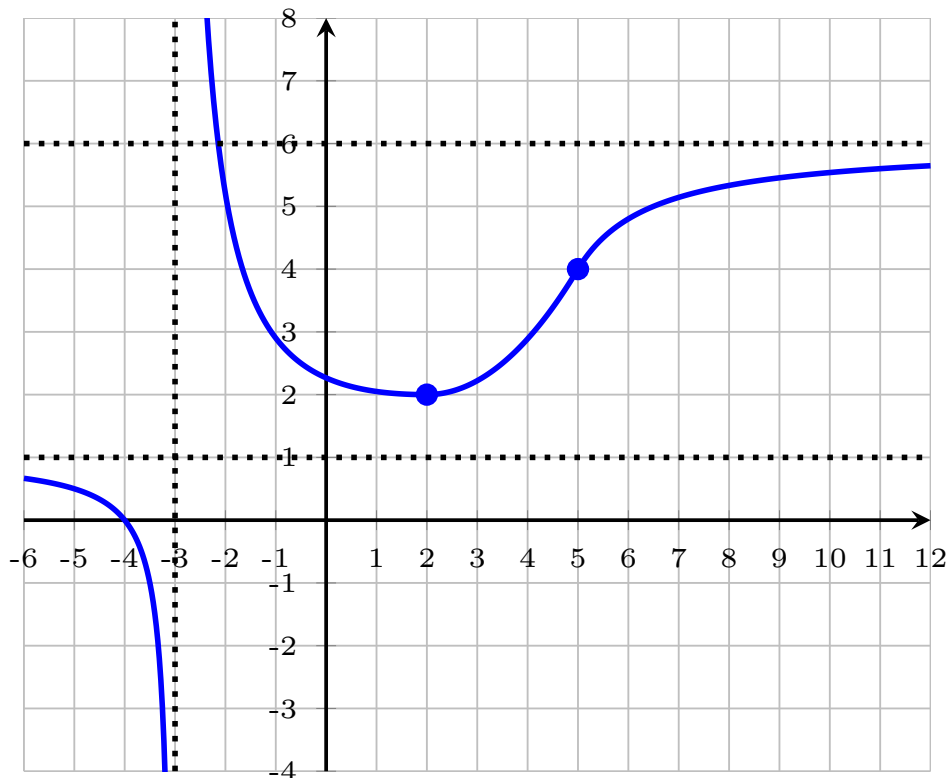
**28 p**

211. The first and second derivative of f are given below. You may assume that $f(x)$ has a vertical asymptote at $x = 25$ only, but do not attempt to calculate $f(x)$ explicitly.

$$f'(x) = \frac{(x+2)^{1/5}}{(x-25)^2}, \quad f''(x) = \frac{-9(x+5)}{5(x-25)^3(x+2)^{4/5}}$$

Fill in the table below with information about the graph of $y = f(x)$. For each part, write "NONE" as your answer if appropriate. Where applicable, give a comma-separated list of intervals that are as inclusive as possible.

You do not have to show work, and each table item will be graded with no partial credit.

Solution

where f is decreasing	$(-\infty, -2]$
where f is increasing	$[-2, 25), (25, \infty)$
x -coordinate(s) of local minima of f	$x = -2$
x -coordinate(s) of local maxima of f	NONE
where f is concave down	$(-\infty, -5], (25, \infty)$
where f is concave up	$[-5, 25)$
x -coordinate(s) of inflection point(s) of f	$x = -5$

The derivatives of f are

$$f'(x) = \frac{(x+2)^{1/5}}{(x-25)^2}, \quad f''(x) = \frac{-9(x+5)}{5(x-25)^3(x+2)^{4/5}}$$

(i) *Vertical asymptotes and horizontal asymptotes.*

Not required since $f(x)$ is not given, but we are given that $x = 25$ is the only vertical asymptote of $f(x)$.

(ii) *Intervals of increase and local extrema.*

We calculate a sign chart for the first derivative. The cut points are the solutions to $f'(x) = 0$ ($x = -2$) and where $f'(x)$ is undefined ($x = 25$).

interval	test point	sign of f'	shape of f
$(-\infty, -2)$	$f'(-3)$	$\ominus = \ominus$	decreasing
$(-2, 25)$	$f'(0)$	$\oplus = \oplus$	increasing
$(25, \infty)$	$f'(30)$	$\oplus = \oplus$	increasing

Hence we deduce the following about f :

$$\begin{aligned} f \text{ is decreasing on:} & \quad (-\infty, -2] \\ f \text{ is increasing on:} & \quad [-2, 25), (25, \infty) \\ f \text{ has a local min at:} & \quad x = -2 \\ f \text{ has a local max at:} & \quad \text{none} \end{aligned}$$

(iii) *Intervals of concavity and inflection points.*

We calculate a sign chart for the second derivative: The cut points are the solutions to $f''(x) = 0$ ($x = -5$) and where $f''(x)$ is undefined ($x = -2$ and $x = 25$).

interval	test point	sign of f''	shape of f
$(-\infty, -5)$	$f''(-6)$	$\frac{-9}{5} \ominus = \ominus$	concave down
$(-5, -2)$	$f''(-4)$	$\frac{-9}{5} \oplus = \oplus$	concave up
$(-2, 25)$	$f''(0)$	$\frac{-9}{5} \oplus = \oplus$	concave up
$(25, \infty)$	$f''(30)$	$\frac{-9}{5} \ominus = \ominus$	concave down

Hence we deduce the following about f :

$$\begin{aligned} f \text{ is concave down on:} & \quad (-\infty, -5], (25, \infty) \\ f \text{ is concave up on:} & \quad [-5, 25) \\ f \text{ has an infl. point at:} & \quad x = -5 \end{aligned}$$

(iv) *Sketch of graph.*

Not required.

34 p

212. A rectangular box with a square base and no top is being constructed to hold a volume of 150 cm^3 . The material for the base of the container costs $\$6/\text{cm}^2$ and the material for the sides of the container costs $\$2/\text{cm}^2$. Find the dimensions of the cheapest possible container.

You must use calculus-based methods in your work. You must also justify that your answer really does give the maximum.

Solution

Let x be the length of the square base and let y be the height of the box, both measured in cm. Our objective function is the total cost of the box, which is given by:

$$C(x, y) = \underbrace{6x^2}_{\text{cost of base}} + \underbrace{8xy}_{\text{cost of sides}}$$

Our constraint is that the volume must be 150 cm^3 , whence $x^2y = 150$, or $y = 150/x^2$. Hence our objective function in terms of x only is

$$f(x) = C\left(x, \frac{150}{x^2}\right) = 6x^2 + \frac{1200}{x}$$

We seek an absolute minimum of f on the interval of interest $(0, \infty)$. We have:

$$f'(x) = 12x - \frac{1200}{x^2}$$

The only positive solution to $f'(x) = 0$, and thus our only critical point, is $x = 100^{1/3}$. Observe that $f''(x) = 12 + \frac{2400}{x^3} > 0$ for all $x > 0$. Hence f is concave up on $(0, \infty)$, whence $x = 100^{1/3}$ gives a local minimum of f . Since this is the only critical point, it must also give the absolute minimum.

The dimensions of the cheapest box are $x = 100^{1/3}$ and $y = \frac{150}{100^{2/3}}$.

1.9 Spring 2021

Midterm Exam #1

- 18 p 213. For each part, use the graph of $y = f(x)$.

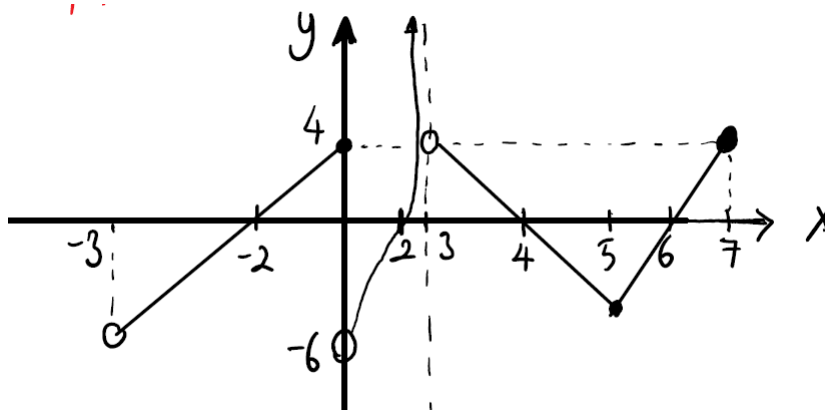

- (a) Calculate $f(f(2))$.
 (b) Find where $f(x) = 0$.
 (c) State the domain of f in interval notation.
 (d) State the range of f in interval notation.
 (e) For each part below, calculate the limit or show that it does not exist. If the limit is $+\infty$ or $-\infty$, write that as your answer, instead of "does not exist".

(i) $\lim_{x \rightarrow 0^-} f(x)$ (ii) $\lim_{x \rightarrow 0^+} f(x)$ (iii) $\lim_{x \rightarrow 0} f(x)$ (iv) $\lim_{x \rightarrow 3^-} f(x)$ (v) $\lim_{x \rightarrow 3^+} f(x)$

Solution

- (a) $f(f(2)) = f(0) = 4$
 (b) $x = -2, x = 2, x = 4, x = 6$
 (c) $(-3, 3) \cup (3, 7]$
 (d) $(-6, \infty)$
 (e) (i) 4
 (ii) -6
 (iii) does not exist
 (iv) $+\infty$
 (v) 4

- 12 p 214. Suppose you have exactly 840 ft of fencing that will be used to build an enclosure that consists of two identical rectangular pens that share a common fence. Let x be the (vertical) length of each pen and let y be the (horizontal) width of each pen. See the figure below.

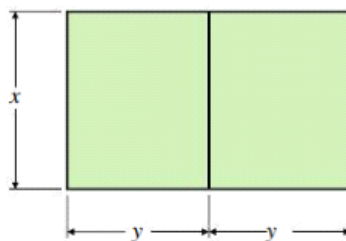

- (a) Find an expression for $F(x)$, the area of one individual pen, as a function of x .
- (b) Now suppose that, for each of the two pens, the sum of the length and width must not exceed 250 ft. In the context of this problem, what is the domain of F ? Write your answer in interval notation.

Solution

- (a) Since we have 840 total fencing, we have that $3x + 4y = 840$, or $y = \frac{1}{4}(840 - 3x)$. The area of one individual pen is xy . Hence $F(x) = \frac{1}{4}x(840 - 3x)$.
- (b) For one pen we are given that $x + y \leq 250$, or $x + \frac{1}{4}(840 - 3x) \leq 250$. Rearranging this inequality gives $x \leq 160$. Of course, the length x must be non-negative (so $x \geq 0$) and the width y must also be non-negative (so $\frac{1}{4}(840 - 3x) \geq 0$, or $x \leq 280$). Putting these restrictions altogether gives the domain of F as $[0, 160]$ (or $0 \leq x \leq 160$).

8 p

215. Suppose $\log_3(x) = A$ and $\log_3(y) = B$. Rewrite the expression below in terms of A and B . Your final answer may not contain any logarithm symbol.

$$\log_3\left(\frac{27\sqrt{x}}{y^4}\right)$$

Solution

We have the following:

$$\log_3\left(\frac{27\sqrt{x}}{y^4}\right) = \log_3(27) + \log_3(\sqrt{x}) - \log_3(y^4) = 3 + \frac{1}{2}\log_3(x) - 4\log_3(y) = 3 + \frac{1}{2}A - 4B$$

10 p

216. Determine whether the following statement is true or false. Explain your answer in 1 or 2 sentences. Your answer should contain English with few mathematical symbols.

“Suppose f and g are functions with $g(3) = 1$. Put $H(x) = \frac{f(x)}{g(x) - 1}$. Then H must have a vertical asymptote at $x = 3$.”

Solution

False. Let $f(x) = x - 3$ and $g(x) = x - 2$. Then $g(3) = 1$ but $H(x) = \frac{f(x)}{g(x) - 1} = \frac{x-3}{x-3}$ does not have a vertical asymptote at $x = 3$ since $\lim_{x \rightarrow 3} H(x) = 1$ (i.e., the limit exists and is finite).

Other acceptable explanations:

- “Since the limit of f and g (and hence the limit of H) as $x \rightarrow 3$ does not depend on the function values $f(3)$ and $g(3)$, we cannot say for sure whether H has a vertical asymptote at $x = 3$. There is not enough information.”
- “If $f(3) = 0$, then direct substitution of $x = 3$ into H gives the indeterminate form $\frac{0}{0}$, which does not necessarily indicate a vertical asymptote. There may be some algebraic cancellation that allows the limit $\lim_{x \rightarrow 3} H(x)$ to exist.”

8 p

217. Suppose $\lim_{x \rightarrow 0} f(x) = 4$. Calculate $\lim_{x \rightarrow 0} \left(\frac{xf(x)}{\sin(5x)} \right)$ or show that the limit does not exist. If the limit is “ $+\infty$ ” or “ $-\infty$ ”, write that as your answer, instead of “does not exist”.

Solution

We have

$$\lim_{x \rightarrow 0} \left(\frac{xf(x)}{\sin(5x)} \right) = \lim_{x \rightarrow 0} \left(\frac{1}{5} \cdot \frac{5x}{\sin(5x)} \cdot f(x) \right) = \frac{1}{5} \cdot 1 \cdot 4 = \frac{4}{5}$$

12 p

218. Consider the following limit, where a is an unspecified constant.

$$\lim_{x \rightarrow -3} \left(\frac{x^2 - a}{x^3 + x^2 - 6x} \right)$$

- (a) Find the value of a for which this limit exists.
 (b) For this value of a , calculate the value of the limit.

Solution

- (a) Direct substitution of $x = -3$ gives the undefined expression “ $\frac{9-a}{0}$ ”. If the given limit exists, then the only possibility is that this undefined expression is, in fact “ $\frac{0}{0}$ ”. (If the expression were “ $\frac{\text{nonzero}}{0}$ ”, we would have a vertical asymptote at $x = -3$ instead.) Hence $9 - a = 0$, and so $a = 9$.
 (b) With $a = 9$, we have the following.

$$\lim_{x \rightarrow -3} \left(\frac{x^2 - 9}{x^3 + x^2 - 6x} \right) = \lim_{x \rightarrow -3} \left(\frac{(x-3)(x+3)}{x(x-2)(x+3)} \right) = \lim_{x \rightarrow -3} \left(\frac{x-3}{x(x-2)} \right) = -\frac{2}{5}$$

16 p

219. Consider the following function, where k is an unspecified constant.

$$g(x) = \begin{cases} xe^{x+4} - 7 \ln(x+5) & x < -4 \\ -4 \cos(\pi x) & -4 < x < 5 \\ 10 & x = 5 \\ \sqrt{2x-5} + k & 5 < x \end{cases}$$

Note that $g(-4)$ is undefined.

- (a) Does $\lim_{x \rightarrow -4} g(x)$ exist? Choose the best answer below.
- Yes, $\lim_{x \rightarrow -4} g(x)$ exists and is equal to _____.
 - Yes, $\lim_{x \rightarrow -4} g(x)$ exists but we cannot determine its value with the given information.
 - No, $\lim_{x \rightarrow -4} g(x)$ does not exist because the corresponding one-sided limits are not equal.
 - No, $\lim_{x \rightarrow -4} g(x)$ does not exist because $g(-4)$ does not exist.
 - No, $\lim_{x \rightarrow -4} g(x)$ does not exist because the limit is infinite.
- (b) Calculate the following limits. Your answer may contain k .

(i) $\lim_{x \rightarrow 5^-} g(x)$

(ii) $\lim_{x \rightarrow 5^+} g(x)$

(c) Is it possible to choose a value of k so that $\lim_{x \rightarrow 5} g(x)$ exists? If so, what is that value of k ?

Solution

(a) Choice (i). Note the following:

$$\lim_{x \rightarrow -4^-} g(x) = \lim_{x \rightarrow -4^-} (xe^{x+4} - 7 \ln(x+5)) = -4 \cdot 1 - 7 \cdot 0 = -4$$

$$\lim_{x \rightarrow -4^+} g(x) = \lim_{x \rightarrow -4^+} (-4 \cos(\pi x)) = -4 \cdot \cos(-4\pi) = -4$$

The left- and right-limits at $x = -4$ are both equal to -4 , hence $\lim_{x \rightarrow -4} g(x) = -4$. (Note that the function value $g(-4)$, which is undefined, is irrelevant.)

(b) We have the following:

$$(i) \lim_{x \rightarrow 5^-} g(x) = -4 \cos(5\pi) = 4$$

$$(ii) \lim_{x \rightarrow 5^+} g(x) = \lim_{x \rightarrow 5^+} (\sqrt{2x-5} + k) = \sqrt{5} + k$$

(c) Yes. From part (b), we need $4 = \sqrt{5} + k$, or $k = 4 - \sqrt{5}$. (Again, the function value $g(5)$, which is 10, is irrelevant.)

16 p

220. Let $f(x) = \frac{(x+a)(x-3)}{(x-2)(x+1)}$, where a is an unspecified, **positive** constant. For each part, calculate the limit or show that it does not exist. *If the limit is “ $+\infty$ ” or “ $-\infty$ ”, write that as your answer, instead of “does not exist”.*

(a) $\lim_{x \rightarrow 0} f(x)$

(b) $\lim_{x \rightarrow 2^-} f(x)$

(c) $\lim_{x \rightarrow 2^+} f(x)$

(d) $\lim_{x \rightarrow 2} f(x)$

Solution

(a) Use direct substitution.

$$\lim_{x \rightarrow 0} f(x) = \frac{(0+a)(0-3)}{(0-2)(0+1)} = \frac{3a}{2}$$

(b) Substitution of $x = 2$ gives “ $\frac{-(2+a)}{0}$ ”. Since $a > 0$, this expression is “ $\frac{\text{nonzero}}{0}$ ”, which means $x = 2$ is a vertical asymptote of f . So we must perform a sign analysis.

We have $-(2+a) < 0$, and so the numerator is negative as $x \rightarrow 2$. For the denominator, we note that since $x \rightarrow 2^-$ (i.e., $x < 2$), we have $x+1 > 0$ and $x-2 < 0$. Hence the entire expression for $f(x)$ is positive as $x \rightarrow 2^-$. Hence $\lim_{x \rightarrow 2^-} f(x) = \infty$.

(c) As in part (b), we perform a sign analysis. However, since $x \rightarrow 2^+$, we have $x-2 > 0$ now. Hence $\lim_{x \rightarrow 2^+} f(x) = -\infty$.

(d) The limits in parts (b) and (c) are not equal, so $\lim_{x \rightarrow 2} f(x)$ does not exist.

Midterm Exam #2

- 12 p** 221. The following limit represents the derivative of a function f at a point a .

$$f'(a) = \lim_{h \rightarrow 0} \left(\frac{5 \ln(e^4 + h) - 20}{h} \right)$$

- (a) Find a possible function $f(x)$.
 (b) For your choice of f in part (a), find a possible value of a .
 (c) Calculate the value of the limit. Explain your calculation briefly in one sentence.

Solution

We compare the limit to the definition of the derivative.

$$f'(a) = \lim_{h \rightarrow 0} \left(\frac{f(a+h) - f(a)}{h} \right)$$

- (a) $f(x) = 5 \ln(x)$
 (b) $a = e^4$ (note that $f(e^4) = 5 \cdot 4 = 20$)
 (c) We have $f'(e^4) = \left. \frac{5}{x} \right|_{x=e^4} = \frac{5}{e^4}$.

- 12 p** 222. Use the graph of f below to answer the following questions. Dashed lines indicate the location of asymptotes.

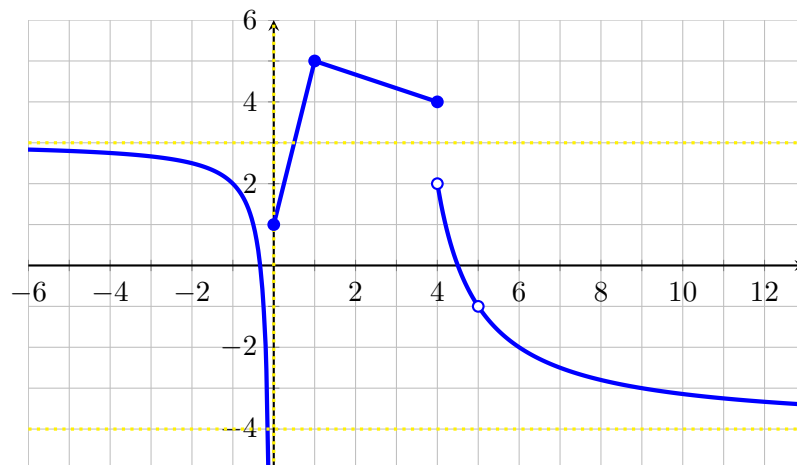

- (a) Calculate $\lim_{x \rightarrow \infty} f(x)$.
 (b) Calculate $\lim_{x \rightarrow -\infty} f(x)$.
 (c) List the values of x where f is not continuous.
 (d) List the values of x where f is not differentiable.
 (e) What is the sign of $f'(-1)$? (choices: positive, negative, zero, does not exist)
 (f) What is the sign of $f'(0.5)$? (choices: positive, negative, zero, does not exist)

Solution

- (a) $\lim_{x \rightarrow \infty} f(x) = -4$
 (b) $\lim_{x \rightarrow -\infty} f(x) = 3$
 (c) $x = 0, x = 4, x = 5$
 (d) $x = 0, x = 1, x = 4, x = 5$
 (e) negative
 (f) positive

16 p

223. Consider the function g below, where a and b are unspecified constants. Assume that g is continuous for all x .

$$g(x) = \begin{cases} be^x + a + 1 & x \leq 0 \\ ax^2 + b(x + 3) & 0 < x \leq 1 \\ a \cos(\pi x) + 7bx & 1 < x \end{cases}$$

- (a) What relation must hold between a and b for g to be continuous at $x = 0$? Your answer should be an equation involving a and b .
 (b) What relation must hold between a and b for g to be continuous at $x = 1$? Your answer should be an equation involving a and b .
 (c) Calculate the values of a and b .

Solution

- (a) The left- and right-limits of $g(x)$ at $x = 0$ must be equal.

$$\begin{aligned} \lim_{x \rightarrow 0^-} g(x) &= \lim_{x \rightarrow 0^-} (be^x + a + 1) = b + a + 1 \\ \lim_{x \rightarrow 0^+} g(x) &= \lim_{x \rightarrow 0^+} (ax^2 + b(x + 3)) = 3b \end{aligned}$$

Hence we must have $b + a + 1 = 3b$, or $a = 2b - 1$.

- (b) The left- and right-limits of $g(x)$ at $x = 1$ must be equal.

$$\begin{aligned} \lim_{x \rightarrow 1^-} g(x) &= \lim_{x \rightarrow 1^-} (ax^2 + b(x + 3)) = a + 4b \\ \lim_{x \rightarrow 1^+} g(x) &= \lim_{x \rightarrow 1^+} (a \cos(\pi x) + 7bx) = -a + 7b \end{aligned}$$

Hence we must have $a + 4b = -a + 7b$, or $2a - 3b = 0$.

- (c) The equations from parts (a) and (b) must be true simultaneously. Putting the equation from part (a) into the equation from part (b) gives $2(2b - 1) - 3b = 0$, whence $b = 2$. Part (a) then implies $a = 3$.

12 p

224. For each part, mark “T” if the statement is true or mark “F” if the statement is false. You do not have to explain your answers or show any work.

- (a) T F If $\lim_{x \rightarrow a} f(x)$ can be evaluated by direct substitution, then f is continuous at $x = a$.
 (b) T F The value of $\lim_{x \rightarrow a} f(x)$, if it exists, is found by calculating $f(a)$.
 (c) T F If f is not differentiable at $x = a$, then f is also not continuous at $x = a$.

Solution

- (a) **True.** This statement is equivalent to $\lim_{x \rightarrow a} f(x) = f(a)$ which is the definition of continuity (of $f(x)$ at $x = a$).
- (b) **False.** The limit $\lim_{x \rightarrow a} f(x) = f(a)$ is independent of $f(a)$. (Indeed, the latter need not even exist for the limit to exist.)
- (c) **False.** The function $f(x) = |x|$ is not differentiable at $x = 0$ but continuous for all x .

20 p

225. Suppose that an equation of the tangent line to f at $x = 5$ is $y = 3x - 8$. Let $g(x) = \frac{f(x)}{x^2 + 10}$.

- (a) Calculate $f(5)$ and $f'(5)$.
- (b) Calculate $g(5)$ and $g'(5)$.
- (c) Write down an equation of the tangent line to g at $x = 5$.

Solution

- (a) The tangent line to f at $x = a$ has slope $f'(a)$ and passes through $(a, f(a))$. The line $y = 3x - 8$, which is tangent to f at $x = 5$ passes through the point $(5, 7)$, whence $f(5) = 7$. the same line has slope 3, whence $f'(5) = 3$.
- (b) We have $g(5) = \frac{f(5)}{35} = \frac{1}{5}$. We use quotient rule to find $g'(x)$.

$$g'(x) = \frac{f'(x) \cdot (x^2 + 10) - f(x) \cdot 2x}{(x^2 + 10)^2}$$

$$\text{Hence } g'(5) = \frac{3 \cdot 35 - 7 \cdot 10}{35^2} = \frac{1}{35}.$$

- (c) The tangent line to g at $x = 5$ is $y = \frac{1}{5} + \frac{1}{35}(x - 5)$.

12 p

226. Suppose $f(2) = -7$ and $f'(2) = 3$.

- (a) Let $g(x) = \cos(x)f(x)$. Calculate $g'(2)$.
- (b) Let $h(x) = e^{2f(x)+3}$. Calculate $h'(2)$.

Solution

- (a) We use product rule.

$$g'(x) = -\sin(x)f(x) + \cos(x)f'(x)$$

$$\text{Hence } g'(2) = 7 \sin(2) + 3 \cos(2).$$

- (b) We use chain rule.

$$h'(x) = e^{2f(x)+3} \cdot 2f'(x)$$

$$\text{Hence } h'(2) = 6e^{-11}.$$

16 p

227. Let $f(x) = x^2 + bx + c$, where b and c are unspecified constants. An equation of the tangent line to f at $x = 3$ is $12x + y = 10$.

- (a) Calculate $f(3)$ and $f'(3)$. Your answers must not contain the letters b or c .
- (b) Calculate the value of b .
- (c) Calculate the value of c .

Solution

- (a) The tangent line to f at $x = 3$ is $12x + y = 10$, which passes through the point $(3, -26)$, whence $f(3) = -26$. The same line has slope -12 , whence $f'(3) = -12$.
- (b) We have $f'(x) = 2x + b$, whence $f'(3) = 6 + b$. From part (a), we must have $6 + b = -12$, whence $b = -18$.
- (c) We have $f(x) = x^2 - 18x + c$, whence $f(3) = -45 + c$. From part (a), we must have $-45 + c = -26$, whence $c = 19$.

Midterm Exam #3

20 p

228. A local gym has two cylindrical swimming pools. The larger pool has radius 20 meters and is filled with water. The smaller pool has radius 12 meters and is empty. Water is drained from the large pool and immediately emptied into the small pool. The height of the water in the small pool increases at a rate of 0.2 m/min.

Let V_L , V_S , h_L , and h_S refer to the volume of the large pool, volume of the small pool, height of the large pool, and height of the small pool, respectively.

- (a) How are $\frac{dV_L}{dt}$ and $\frac{dV_S}{dt}$ related?
- (b) What is the sign of $\frac{dh_L}{dt}$?
- (c) Find $\frac{dV_S}{dt}$.
- (d) Find $\frac{dh_L}{dt}$.

Solution

(a) The water in the two pools change at the same absolute rate. But the large pool drains while the small pool fills. Hence $\frac{dV_L}{dt} = -\frac{dV_S}{dt}$.

(b) Water drains from the larger pool, whence $\frac{dh_L}{dt}$ is negative.

(c) We have $V_S = 144\pi h_S$, whence $\frac{dV_S}{dt} = 144\pi \frac{dh_S}{dt}$. Given that $\frac{dh_S}{dt} = 0.3$, we find $\frac{dV_S}{dt} = 28.8\pi \text{ m}^3/\text{min}$.

(d) We have $V_L = 400\pi h_L$, whence $\frac{dV_L}{dt} = 400\pi \frac{dh_L}{dt}$. Using parts (a) and (c), we have:

$$-28.8\pi = -\frac{dV_S}{dt} = \frac{dV_L}{dt} = 400\pi \frac{dh_L}{dt}$$

Hence $\frac{dh_L}{dt} = -0.072 \text{ m/min}$.

10 p

229. Use the identity $4^2 + \sqrt{4} = 18$ and linear approximation to estimate $(3.81)^2 + \sqrt{3.81}$.

Solution

Put $f(x) = x^2 + \sqrt{x}$. We use the tangent line to f at $x = 4$. Observe that $f(4) = 18$ and $f'(x) = 2x + \frac{1}{2\sqrt{x}}$, whence $f'(4) = \frac{35}{4}$. Hence the tangent line to f at $x = 4$ is

$$y = 18 + \frac{35}{4}(x - 4)$$

Since $x = 3.81$ is near the point of tangency ($x = 4$), we have

$$(3.81)^2 + \sqrt{3.81} \approx 18 + \frac{35}{4}(3.81 - 4) = 16.3375$$

- 15 p** **230.** The total cost (in dollars) of producing x items is modeled by the function $C(x) = x^2 + 4x + 3$, and the price per item (in dollars) is $p(x) = \frac{98x + 49}{x + 3}$.
- (a) Calculate the exact cost of producing the 5th item.
- (b) Using marginal analysis, estimate the revenue derived from producing the 5th item.

Solution

(a) $C(5) - C(4) = 48 - 35 = 13$.

(b) The revenue is $R(x) = xp(x) = \frac{98x^2 + 49x}{x + 3}$. Hence the desired marginal revenue is

$$R'(4) = \left(\frac{49(2x^2 + 12x + 3)}{(x + 3)^2} \right) \Big|_{x=4} = 83$$

- 20 p** **231.** Consider the curve defined by the equation below, where a and b are unspecified constants.

$$\sqrt{xy} = ay^3 + b$$

Suppose the equation of the tangent line to the curve at the point $(3, 3)$ is $y = 3 + 4(x - 3)$.

- (a) What is the value of $\frac{dy}{dx}$ at $(3, 3)$?
- (b) Calculate a and b .

Solution

(a) The slope of the tangent is line is 4, hence $\frac{dy}{dx} = 4$ at $(3, 3)$.

(b) We first use implicit differentiation on the equation of the curve.

$$\frac{1}{2}(xy)^{-1/2} \cdot \left(x \frac{dy}{dx} + y \right) = 3ay^2 \cdot \frac{dy}{dx}$$

We now substitute $x = 3$, $y = 3$, and $\frac{dy}{dx} = 4$, which gives us $\frac{15}{6} = 108a$, whence $a = \frac{5}{216}$. We now substitute $x = 3$, $y = 3$, and $a = \frac{5}{216}$ into the equation for the curve, which gives us $3 = \frac{135}{216} + b$, whence $b = \frac{19}{8}$.

- 15 p** **232.** Suppose $f''(x)$ is continuous. You are also given the following values:

$$f\left(\frac{1}{8}\right) = 20 \quad , \quad f'\left(\frac{1}{8}\right) = -22$$

Calculate the following limit or show that it does not exist. *If the limit is “ $+\infty$ ” or “ $-\infty$ ”, write that as your answer, instead of “does not exist”.*

$$\lim_{x \rightarrow 8} \left(\frac{20 - f\left(\frac{1}{x}\right)}{x^2 + x - 72} \right)$$

Solution

Since f is continuous, we may substitute $x = 8$ to obtain the indeterminate form " $\frac{0}{0}$ ". So we may use L'Hospital's Rule.

$$\lim_{x \rightarrow 8} \left(\frac{20 - f\left(\frac{1}{x}\right)}{x^2 + x - 72} \right) \stackrel{H}{=} \lim_{x \rightarrow 8} \left(\frac{-f'\left(\frac{1}{x}\right) \cdot \left(-\frac{1}{x^2}\right)}{2x + 1} \right)$$

Since f' is continuous, we substitute $x = 8$, and we find the limit is $\frac{-(-22) \cdot \left(-\frac{1}{8^2}\right)}{17} = -\frac{11}{544}$.

20 p

- 233.** The length L (measured in meters) of a certain fish depends on time t (measured in years since birth) and is modeled by the function f .

$$L = f(t) = 4t^{2.99}$$

The mass m (measured in kilograms) of the fish depends on the length L and is modeled by the function g .

$$m = g(L)$$

The function g is not explicitly given.

- Describe in one English sentence, as precisely and specifically as you can, what the quantity $Q = f(4) - f(0)$ represents in the context of this problem.
- Describe in one English sentence, as precisely and specifically as you can, what the quantity $f'(1)$ represents in the context of this problem.
- What are the units of $g'(4.87)$?
- Suppose that $\frac{dm}{dL} = 7$ when $L = 4$. (Note that $L = 4$ when $t = 1$.) At what rate (measured in kg/yr) is the mass of the fish changing with respect to time exactly 1 year after its birth?

Solution

- The quantity Q is the length the fish grows in the first 4 years of its life.
- The quantity $f'(1)$ is the rate at which the length of the fish is changing with respect to time exactly 1 year after its birth.
- The number $g'(4.87)$ is the same as $\frac{dm}{dL}$ evaluated at $L = 4.87$, whence $g'(4.87)$ has units of kg/m (kilograms per meter).
- Note that $m = g(L) = g(f(t))$. By the chain rule, we have

$$\frac{dm}{dt} = g'(f(t)) \cdot f'(t)$$

We put $t = 1$ and note that $f(1) = 4$ and $f'(1) = (11.96t^{1.99})|_{x=1} = 11.96$. Hence

$$\left. \frac{dm}{dt} \right|_{t=1} = g'(f(1)) \cdot f'(1) = g'(4) \cdot f'(1) = 7 \cdot 11.96 = 83.72$$

Midterm Exam #4

- 16 p** 234. Consider the function below, where A is an unspecified, **positive** constant.

$$f(x) = \frac{A}{x - 8\sqrt{x} + 60}$$

For parts (c) and (d) only, assume the absolute minimum of f on $[0, 21]$ is 8.

- List all x -values that must be tested to find the absolute extrema of f on $[0, 21]$.
- At which x -value does the absolute minimum of f occur on $[0, 21]$?
- Find the value of A .
- Find the absolute maximum of f on $[0, 21]$ and all x -values at which it occurs.

Solution

- We must test the endpoints of the interval ($x = 0$ and $x = 21$), as well as any critical points. Note that f is differentiable on $(0, 21)$, so the only critical points are solutions to $f'(x) = 0$.

$$f'(x) = \frac{-A \left(1 - \frac{4}{\sqrt{x}}\right)}{(x - 8\sqrt{x} + 60)^2}$$

Hence the only critical point (and only other number we must test) is $x = 16$.

- We test the x -values in part (a). Observe the following: $f(0) = \frac{A}{60}$, $f(16) = \frac{A}{44}$, and $f(21) = \frac{A}{81 - 8\sqrt{21}} \approx \frac{A}{44.3}$. Hence the minimum of f on $[0, 21]$ occurs at $x = 0$.
- We are given that the minimum is 8, and so part (b) implies $f(0) = \frac{A}{60} = 8$. Hence $A = 480$.
- From part (b), the absolute maximum is $f(16) = \frac{A}{44} = \frac{480}{44} = \frac{120}{11}$ (occurring only at $x = 16$).

- 18 p** 235. An airline policy states that all baggage must be shaped like a rectangular box with the sum of the length, width, and height not exceeding 122 inches. You plan to purchase a bag from a company that makes customized bagged whose height must be 3 times its width. Find the dimensions of the baggage with the largest volume. (Let L , W , and H be the length, width, and height of the baggage, respectively.)

- Before considering any constraints particular to this problem, find the objective function in terms of L , W , and H .
- There are two constraints for this problem. One constraint is from the airline and the other is from the baggage company. Find these constraints.
- Write the objective function in terms of W only.
- Find the interval of interest for the objective function in part (c).
- Find the dimensions of the baggage with the largest volume.

Solution

- We seek the largest volume, whence the objective is $F(L, W, H) = LWH$.
- The airline gives the constraint $L + W + H = 122$ and the baggage company gives the constraint $H = 3W$.
- From part (b), we have $L = 122 - W - H = 122 - 4W$, and so the objective in terms of W only is

$$f(W) = f(122 - 4W, W, 3W) = 366W^2 - 12W^3$$

- (d) All measurements must be non-negative. So we must have $L \geq 0$ (equivalent to $W \leq \frac{122}{4} = \frac{61}{2}$), $W \geq 0$, and $H \geq 0$ (equivalent to $W \geq 0$). Hence the interval of interest for W is $[0, \frac{61}{2}]$.
- (e) Observe that $f'(W) = 732W - 36W^2 = 12W(61 - 3W)$, hence the only critical point of f is $W = \frac{61}{3}$. To verify this gives us a maximum volume, we note that $f(0) = f(\frac{61}{2}) = 0$ (testing endpoints). Since $f(\frac{61}{3})$ is clearly positive, we must have an absolute maximum of f on the interval at $W = \frac{61}{3}$. The desired dimensions are thus:

$$L = \frac{122}{3} \quad , \quad W = \frac{61}{3} \quad , \quad H = 61$$

- 14 p** 236. Consider the function $f(x)$ whose second derivative is given.

$$f''(x) = \frac{(x-2)^2(x-5)^3}{(x-9)^5}$$

You may assume the domain of $f(x)$ is $(-\infty, 9) \cup (9, \infty)$.

Find where $f(x)$ is concave down, where $f(x)$ is concave up, and where $f(x)$ has an inflection point. Write "NONE" as your answer if appropriate. Where applicable, give a comma-separated list of intervals that are as inclusive as possible.

Solution

We calculate a sign chart for the second derivative: The cut points are the solutions to $f''(x) = 0$ ($x = 2$ and $x = 5$) and where $f''(x)$ is undefined ($x = 9$).

interval	test point	sign	shape of f
$(-\infty, 2)$	$f''(0)$	$\frac{\oplus \ominus}{\ominus} = \oplus$	concave up
$(2, 5)$	$f''(3)$	$\frac{\oplus \ominus}{\ominus} = \oplus$	concave up
$(5, 9)$	$f''(6)$	$\frac{\oplus \oplus}{\ominus} = \ominus$	concave down
$(9, \infty)$	$f''(10)$	$\frac{\oplus \oplus}{\oplus} = \oplus$	concave up

Hence we deduce the following about f :

$$\begin{aligned} f \text{ is concave down on: } & [5, 9) \\ f \text{ is concave up on: } & (-\infty, 5], (9, \infty) \\ f \text{ has an infl. point at: } & x = 5 \end{aligned}$$

- 14 p** 237. A particle travels along the x -axis in such a way that its velocity (measured in ft/sec) at any time t (measures in sec) is

$$v(t) = 4t^3 - 2t + 2$$

The particle is at $x = 3$ when $t = 2$.

- (a) Find the position of the particle at any time t .
 (b) Find the position of the particle at time $t = 4$.
 (c) Find the acceleration of the particle when $t = 4$.

Solution

(a) To find the position, we find the antiderivative of $v(t)$ first.

$$x(t) = \int v(t) dt = \int (4t^3 - 2t + 2) dt = t^4 - t^2 + 2t + C$$

We are given $x = 3$ when $t = 2$, whence $3 = 16 - 4 + 4 + C$, and so $C = -13$. The position of the particle at any time t is

$$x(t) = t^4 - t^2 + 2t - 13$$

(b) We have $x(4) = 256 - 16 + 8 - 13 = 235$.

(c) The acceleration is the derivative of velocity, so $a(4) = v'(4) = (12t^2 - 2)|_{t=4} = 190$.

8 p 238. Use the graph of $y = f(x)$ on $[0, 14]$ below to answer the questions.

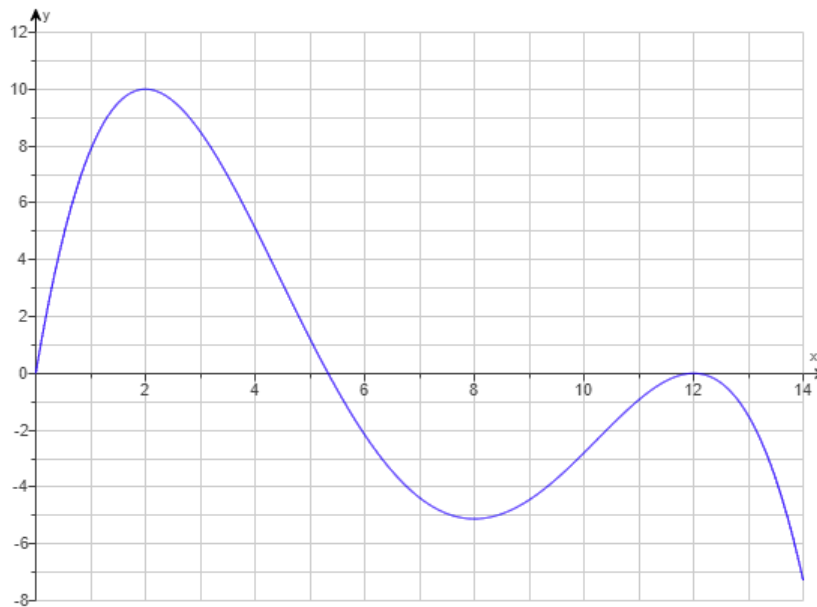

- List the critical points of f in $(0, 14)$.
- How many local extrema does f have on $(0, 14)$?
- Find the absolute maximum of f and the x -value at which it occurs.
- Find the absolute minimum of f and the x -value at which it occurs.

Solution

- The critical points are $x = 2$ (since $f'(2) = 0$), $x = 8$ (since $f'(8) = 0$), and $x = 12$ (since $f'(12) = 0$).
- There are three local extrema (at the three critical points in part (a)).
- The absolute maximum of f is 10 at $x = 2$.
- The absolute minimum of f is -7.3 at $x = 14$. (Any reasonable estimate of -7.3 is acceptable.)

18 p

239. Use the graph of $y = f'(x)$ below to answer the questions. You may assume that $f'(x)$ has a vertical asymptote at $x = 14$ and that the domain of f is $(0, 14) \cup (14, 20)$.

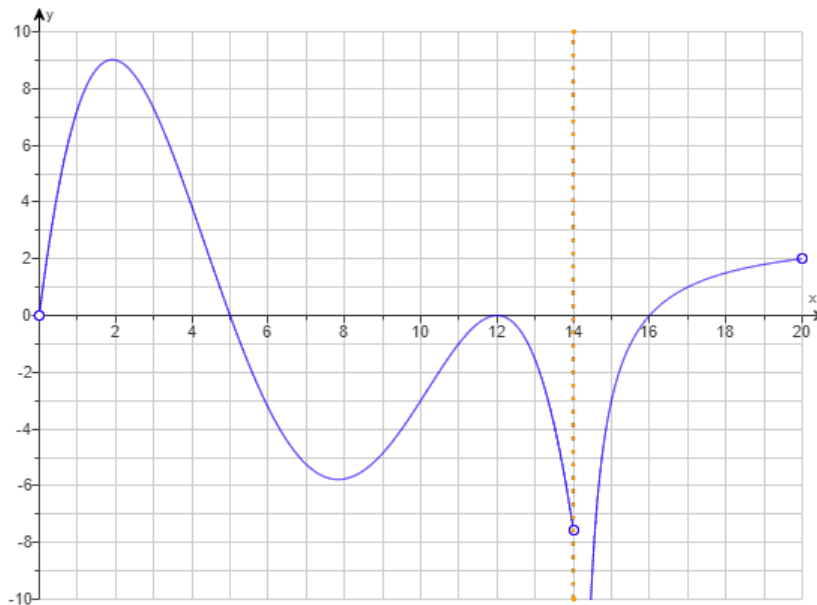

Note: You are given a graph of the first derivative of f , not a graph of f .

- Find the critical points of f .
- Find where f is decreasing, where f is increasing, where f has a local minimum, and where f has a local maximum. Write “NONE” as your answer if appropriate. Where applicable, give a comma-separated list of intervals that are as inclusive as possible.

Solution

- The critical points of f are $x = 5$ (since $f'(5) = 0$), $x = 12$ (since $f'(12) = 0$), and $x = 16$ (since $f'(16) = 0$).
- We calculate a sign chart for the first derivative. The cut points are the solutions to $f'(x) = 0$ ($x = 5$, $x = 12$, and $x = 16$) and the vertical asymptotes ($x = 14$).

interval	test point	sign of f'	shape of f
$(0, 5)$	$f'(1)$	\oplus	increasing
$(5, 12)$	$f'(6)$	\ominus	decreasing
$(12, 14)$	$f'(13)$	\ominus	decreasing
$(14, 16)$	$f'(15)$	\ominus	decreasing
$(16, 20)$	$f'(17)$	\oplus	increasing

Hence we deduce the following about f :

f is decreasing on: $[5, 14), (14, 16]$
 f is increasing on: $(0, 5], [16, 20)$
 f has a local min at: $x = 16$
 f has a local max at: $x = 5$

12 p

240. The figure below shows the graphs of two functions. One function is $f(x)$ and the other is $f'(x)$, but you are not told which is which.

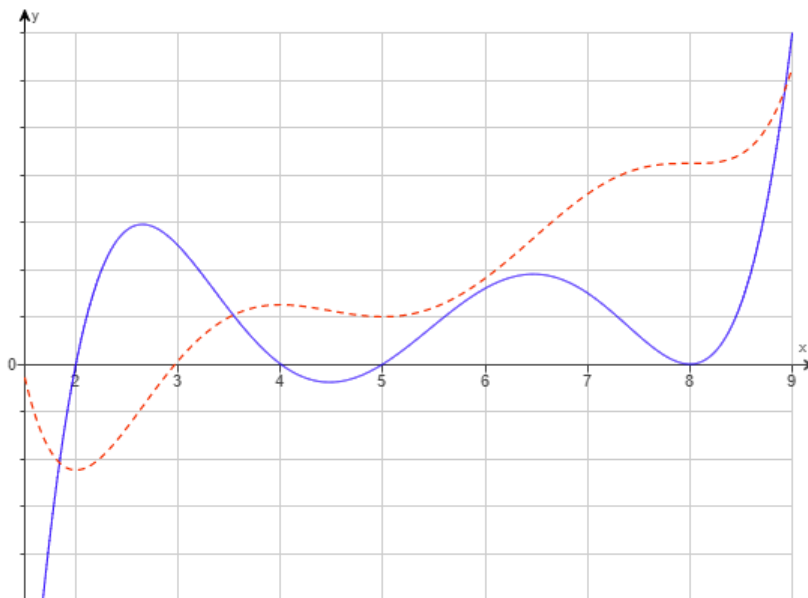

- Which graph is that of $y = f(x)$?
- Explain your answer to part (a) based on the behavior of the graphs at $x = 4$ only.
- Explain your answer to part (a) based on the behavior of the graphs near $x = 3.5$ only.

Solution

- The dashed orange curve is the graph of $y = f(x)$.
- The dashed orange curve has a local maximum at $x = 4$, whereas the blue solid graph crosses the x -axis from above to below (positive to negative values) at $x = 4$. This is consistent only if the dashed orange curve is the graph of $y = f(x)$.
- At $x = 3.5$, the dashed orange curve is increasing (so its derivative should be positive) and concave down (so its derivative should be decreasing). This is consistent only if the blue solid graph is, indeed, the graph of $y = f'(x)$.

1.10 Fall 2021

Precalculus Exam

14 p 241. The graph of $y = f(x)$ is given below.

Note that f is piecewise linear. An explicit formula for $f(x)$ can be written in the following form, where A and B are constants.

$$f(x) = \begin{cases} y_1(x) & \text{if } -8 \leq x < A \\ y_2(x) & \text{if } B \leq x \leq 8 \end{cases}$$

Calculate each of A , B , $y_1(x)$, and $y_2(x)$.

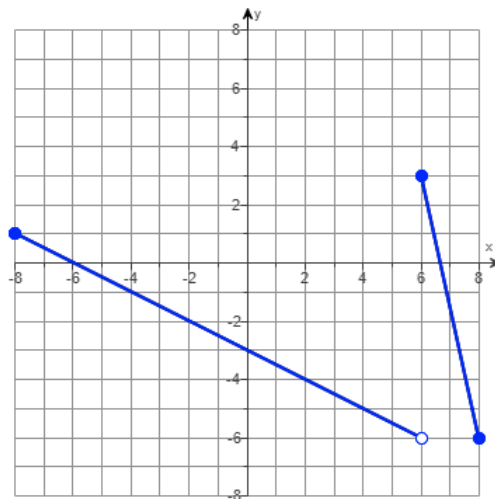
**Solution**

We see that the graph of f consists of two line segments, one valid for $-8 \leq x < 6$ (hence $A = 6$) and the other valid for $6 \leq x \leq 8$ (hence $B = 6$).

We find $y_1(x)$ by finding the equation of the line through $(-8, 1)$ and $(6, -6)$. We find $y_2(x)$ by finding the equation of the line through $(6, 3)$ and $(8, -6)$. So using point-slope form, we have the following:

$$y_1(x) = 1 + \frac{-6 - 1}{6 - (-8)}(x - (-8)) = 1 - \frac{1}{2}(x + 8)$$

$$y_2(x) = -6 + \frac{-6 - 3}{8 - 6}(x - 8) = -6 - \frac{9}{2}(x - 8)$$

10 p 242. For each part, use the graph of $y = f(x)$.

- Calculate $f(f(2))$.
- State the domain of f in interval notation.
- State the range of f in interval notation.

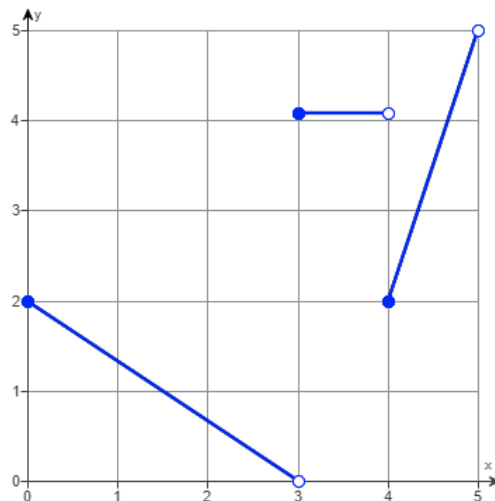

Solution

- (a) Since f is piecewise linear, we can use point-slope form to find an equation for f valid for $0 \leq x < 3$.

$$f(x) = 2 + \frac{0-2}{3-0}(x-0) = 2 - \frac{2}{3}x$$

Hence we find $f(2) = 2 - \frac{2}{3} \cdot 2 = \frac{2}{3}$, whence $f(f(2)) = f(\frac{2}{3}) = 2 - \frac{2}{3} \cdot \frac{2}{3} = \frac{14}{9}$.

- (b) The domain of f is $[0, 5)$.
 (c) The range of f is $(0, 5)$.

9 p

- 243.** Suppose $\log_3(x) = A$ and $\log_3(y) = B$. Rewrite the expression below in terms of A and B . Your final answer may not contain any logarithm symbol.

$$\log_3\left(\frac{27\sqrt{x}}{y^4}\right)$$

Solution

We have the following:

$$\log_3\left(\frac{27\sqrt{x}}{y^4}\right) = \log_3(27) + \log_3(\sqrt{x}) - \log_3(y^4) = 3 + \frac{1}{2}\log_3(x) - 4\log_3(y) = 3 + \frac{1}{2}A - 4B$$

9 p

- 244.** Rewrite the expression below as a single logarithm. Assume x and y are positive.

$$\frac{1}{2}(\log_5(x) - 7\log_5(y)) + 3\log_5(x-1)$$

Solution

We have the following:

$$\begin{aligned} \frac{1}{2}(\log_5(x) - 7\log_5(y)) + 3\log_5(x-1) &= \frac{1}{2}\log_5\left(\frac{x}{y^7}\right) + \log_5((x-1)^3) \\ &= \log_5\left(\frac{x^{1/2}}{y^{7/2}}\right) + \log_5((x-1)^3) \\ &= \log_5\left(\frac{x^{1/2}(x-1)^3}{y^{7/2}}\right) \end{aligned}$$

11 p

- 245.** Suppose $\cos(\theta) = \frac{A}{7}$ with $0 < A < 7$ and $\sin(\theta) < 0$. Find $\sec(\theta)$, $\sin(\theta)$, and $\tan(\theta)$ in terms of A .

Solution

By definition of secant,

$$\sec(\theta) = \frac{1}{\cos(\theta)} = \frac{7}{A}$$

Using the Pythagorean identity $\cos^2(\theta) + \sin^2(\theta) = 1$ and recalling that $\sin(\theta) < 0$, we have

$$\sin(\theta) = -\sqrt{1 - \cos^2(\theta)} = -\sqrt{1 - \frac{A^2}{49}} = -\frac{\sqrt{49 - A^2}}{7}$$

By definition of tangent,

$$\tan(\theta) = \frac{\sin(\theta)}{\cos(\theta)} = \frac{-\sqrt{1 - \frac{A^2}{49}}}{\frac{A}{7}} = -\frac{\sqrt{49 - A^2}}{A}$$

- 11 p** **246.** A bacteria colony has an initial population of 3500. The population grows exponentially and triples every 7 hours. Recall that this means the population P at time t satisfies $P(t) = P_0 e^{kt}$ for some constants P_0 and k .
- Find the exact value of the growth constant k .
 - Find the population after 25 hours.
 - Find the time (in hours) when the population will be 12,600.

Solution

- We are given that $P(7) = 3P(0)$, or $e^{7k} = 3$. Hence $k = \frac{1}{7} \ln(3)$.
- $P(25) = 3500e^{25k} = 3500 \cdot 3^{25/7} \approx 177040$.
- We have to solve the equation $12600 = 3500e^{kt}$ for t . Dividing by 3500 and taking logarithms gives $t = 7 \cdot \frac{\ln(18/5)}{\ln(3)} \approx 8.16$.

- 14 p** **247.** A rectangular box is constructed according to the following rules.

- the length of the box is twice its width
- the height of the box is 5 feet more than three times the length

Let ℓ , w , and h denote the length, width, and height of the box, respectively, measured in feet.

- Write the height of the box in terms of w .
- Write an expression for $V(w)$, the volume of the box measured in cubic feet, as a function of its width.
- Suppose the rules also require that the sum of the box's width and height to be less than 26 feet. Under this condition, what is the domain of the function $V(w)$?

Solution

- The first condition gives $\ell = 2w$, and the second condition gives $h = 3\ell + 5$. Hence $h = 3(2w) + 5 = 6w + 5$.
- The volume of the box is $V(w) = \ell \cdot w \cdot h = 2w \cdot w \cdot (6w + 5)$.
- We are given that $w + h < 26$, or $w + 6w + 5 < 26$. Solving for w gives $w < 3$. Since width must also be non-negative, we find that the domain of $V(w)$ is $0 \leq w < 3$, or $w \in [0, 3)$ in interval notation.

- 10 p** **248.** Let $f(x) = \frac{2}{3x}$ and assume $h \neq 0$. Fully simplify each of the following expressions:

(a) $f(x+h)$

(b) $f(x+h) - f(x)$

(c) $\frac{f(x+h) - f(x)}{h}$

Solution

(a) $f(x+h) = \frac{2}{3(x+h)}$

(b) $f(x+h) - f(x) = \frac{2}{3(x+h)} - \frac{2}{3x}$

(c) We have the following.

$$\frac{f(x+h) - f(x)}{h} = \frac{\frac{2}{3(x+h)} - \frac{2}{3x}}{h} = \frac{2x - 2(x+h)}{3hx(x+h)} = \frac{-2h}{3hx(x+h)} = \frac{-2}{3x(x+h)}$$

12 p

249. Find the domain of the function $f(x) = \sqrt{x^2 + x - 6} + \ln(10 - x)$. Write your answer using interval notation.

Solution

We examine the square root and the logarithm separately.

The argument of the square root cannot be negative, hence we must have $x^2 + x - 6 \geq 0$. This is equivalent to $(x+3)(x-2) \geq 0$. To solve this inequality, we construct a sign chart and test each of the intervals $(-\infty, -3)$, $(-3, 2)$, and $(2, \infty)$. We find that the solution to the inequality is $(-\infty, -3] \cup [2, \infty)$.

The argument of the logarithm cannot be negative or zero, hence we must have $10 - x > 0$, or $x < 10$ (or $(-\infty, 10)$ in interval notation).

The domain of f is the intersection of the solutions to these two inequalities.

$$(-\infty, -3] \cup [2, 10)$$

Midterm Exam #1

10 p 250. For each part, use the graph of $y = f(x)$.

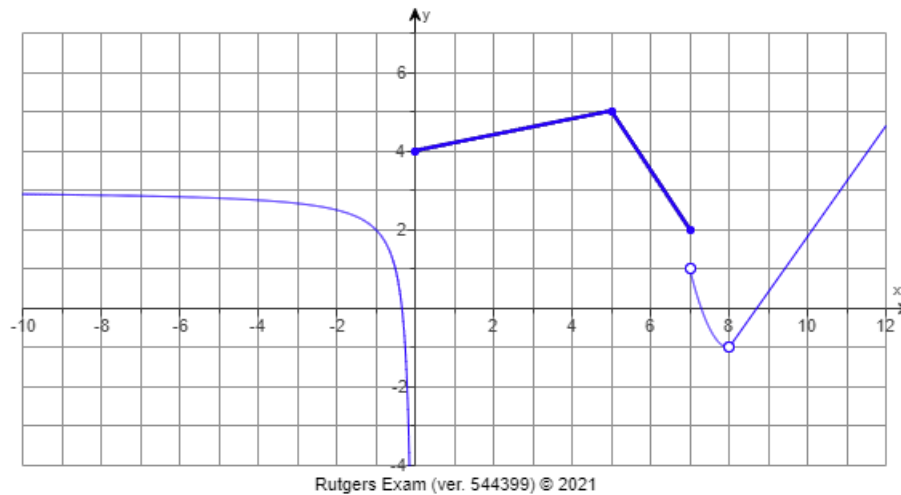

- List the x -values where f is not continuous or determine that f is continuous for all x .
- List all vertical asymptotes of f .
- List all horizontal asymptotes of f .
- Calculate $\lim_{x \rightarrow 8} f(x)$ or determine that the limit does not exist.
- At $x = 7$, which of the one-sided limits of f exist?

Solution

- $x = 0, 7, 8$ only
- $x = 0$ only
- $y = 3$ only
- $\lim_{x \rightarrow 8} f(x) = -1$
- Both the left- and right-limits of $f(x)$ at $x = 7$ exist.

20 p 251. Consider the piecewise-defined function $f(x)$ below; A and B are unspecified constants and $g(x)$ is an unspecified function with domain $[94, \infty)$.

$$f(x) = \begin{cases} Ax^2 + 8 & x < 75 \\ \ln(B) + 6 & x = 75 \\ \frac{x - 75}{\sqrt{x + 6} - 9} & 75 < x < 94 \\ 19 & x = 94 \\ g(x) & x > 94 \end{cases}$$

- Find $\lim_{x \rightarrow 75^-} f(x)$ in terms of A and B .
- Find $\lim_{x \rightarrow 75^+} f(x)$ in terms of A and B .
- Find the exact values of A and B for which f is continuous at $x = 75$.
- Suppose $g(94) = 19$. What does this imply about $\lim_{x \rightarrow 94} f(x)$? Select the best answer.

- (i) $\lim_{x \rightarrow 94} f(x)$ exists.
 (ii) $\lim_{x \rightarrow 94} f(x)$ does not exist.
 (iii) It gives no information about $\lim_{x \rightarrow 94} f(x)$.

Solution

(a) $\lim_{x \rightarrow 75^-} f(x) = \lim_{x \rightarrow 75^-} (Ax^2 + 8) = A \cdot 75^2 + 8 = 5625A + 8$

(b) We have the following:

$$\begin{aligned} \lim_{x \rightarrow 75^+} f(x) &= \lim_{x \rightarrow 75^+} \left(\frac{x - 75}{\sqrt{x + 6} - 9} \right) = \lim_{x \rightarrow 75^+} \left(\frac{x - 75}{\sqrt{x + 6} - 9} \cdot \frac{\sqrt{x + 6} + 9}{\sqrt{x + 6} + 9} \right) \\ &= \lim_{x \rightarrow 75^+} \left(\frac{(x - 75)(\sqrt{x + 6} + 9)}{x + 6 - 81} \right) = \lim_{x \rightarrow 75^+} (\sqrt{x + 6} + 9) \\ &= \sqrt{81} + 9 = 18 \end{aligned}$$

(c) We need the left-limit, right-limit, and function value of $f(x)$ at $x = 75$ all to be equal. Thus we must have:

$$5625A + 8 = 18 = \ln(B) + 6$$

Thus $A = \frac{10}{5625}$ and $B = e^{12}$.

(d) **Choice (iii).** Note that $\lim_{x \rightarrow 94^-} f(x) = \lim_{x \rightarrow 94^-} \left(\frac{x - 75}{\sqrt{x + 6} - 9} \right) = 19$ (use direct substitution). So for $\lim_{x \rightarrow 94} f(x)$ to exist, we require only that $19 = \lim_{x \rightarrow 94^+} f(x) = \lim_{x \rightarrow 94^+} g(x)$. However, we are given no information at all about this right-limit of g since the function value $g(94)$ is irrelevant to its value.

8 p

252. The position of a particle (measured in feet) after t seconds is modeled by the following function.

$$h(t) = -16t^2 + 96t + 100$$

- (a) Calculate the average velocity of the particle (in feet per second) between $t = 4$ and $t = 5$.
 (b) Find an equation of the secant line between $(4, h(4))$ and $(5, h(5))$.

Solution

(a) $\bar{v} = \frac{\Delta h}{\Delta t} = \frac{h(5) - h(4)}{5 - 4} = \frac{-16(25 - 16) + 96(5 - 4)}{1} = -48$

(b) The slope of the secant line is -48 and the secant line passes through $(4, h(4)) = (4, 228)$. Hence an equation of the secant line is $y = 228 - 48(t - 4)$.

4 p

253. Suppose $\lim_{x \rightarrow 6} |f(x)| = 2$. Which of the following statements must be true about $\lim_{x \rightarrow 6} f(x)$?

- (i) $\lim_{x \rightarrow 6} f(x)$ does not exist.
 (ii) $\lim_{x \rightarrow 6} f(x) = 2$.
 (iii) $\lim_{x \rightarrow 6} f(x)$ exists and is equal to either 2 or -2 , but there is not enough information to determine which of these possibilities must be true.
 (iv) There is not enough information about $f(x)$ to determine whether $\lim_{x \rightarrow 6} f(x)$ exists.
 (v) $\lim_{x \rightarrow 6} f(x) = -2$.

Solution

Choice (iv). Consider these two examples, both of which satisfy the hypothesis $\lim_{x \rightarrow 6} |f(x)| = 2$.

- $f(x) = 2$. Then $\lim_{x \rightarrow 6} f(x)$ exists and is equal to 2.
- $f(x) = 2$ for $x < 6$ and $f(x) = -2$ for $x \geq 6$. Then $\lim_{x \rightarrow 6} f(x)$ does not exist (the left- and right-limits at $x = 6$ are not equal).

Thus it is not possible to determine whether $\lim_{x \rightarrow 6} f(x)$ exists.

- 8 p** 254. Consider the following function, where k is an unspecified constant.

$$f(x) = \frac{4x^2 - kx}{x^2 + 12x + 32}$$

- (a) Find the value of k for which $\lim_{x \rightarrow -4} f(x)$ exists.
- (b) For the value of k described in part (a), evaluate $\lim_{x \rightarrow -4} f(x)$.

Solution

- (a) Direct substitution of $x = -4$ into $f(x)$ gives the undefined expression $\frac{64+4k}{0}$. If the number $64 + 4k$ were non-zero, then we would conclude there is a vertical asymptote for f at $x = -4$. However, since $\lim_{x \rightarrow -4} f(x)$ exists, we must have $64 + 4k = 0$, whence $k = -16$.
- (b) With $k = -16$, we have the following.

$$\lim_{x \rightarrow -4} \left(\frac{4x^2 + 16x}{x^2 + 12x + 32} \right) = \lim_{x \rightarrow -4} \left(\frac{4x(x+4)}{(x+8)(x+4)} \right) = \lim_{x \rightarrow -4} \left(\frac{4x}{x+8} \right) = -4$$

- 4 p** 255. Suppose $\lim_{x \rightarrow 0} \left(\frac{f(x)}{x} \right) = 8$. Calculate $\lim_{x \rightarrow 0} \left(\frac{f(x)}{\sin(6x)} \right)$ or show that the limit does not exist. *If the limit is $+\infty$ or $-\infty$, write that as your answer, instead of “does not exist”.*

Solution

We have the following:

$$\lim_{x \rightarrow 0} \left(\frac{f(x)}{\sin(6x)} \right) = \lim_{x \rightarrow 0} \left(\frac{1}{6} \cdot \frac{f(x)}{x} \cdot \frac{6x}{\sin(6x)} \right) = \frac{1}{6} \cdot 8 \cdot 1 = \frac{4}{3}$$

- 12 p** 256. Consider the following function.

$$f(x) = \frac{x^2 - x - 6}{x^3 - 2x^2 - 3x}$$

- (a) Where is f discontinuous?
- (b) At the leftmost x -value where f is discontinuous, what type of discontinuity does f have (removable, jump, infinite (vertical asymptote), or other)?
- (c) At the rightmost x -value where f is discontinuous, what type of discontinuity does f have (removable, jump, infinite (vertical asymptote), or other)?

Solution

First we note the following:

$$f(x) = \frac{x^2 - x - 6}{x^3 - 2x^2 - 3x} = \frac{(x+2)(x-3)}{x(x+1)(x-3)}$$

- (a) The function f is continuous on its domain, hence discontinuous at $x = -1, 0, 3$ only.
- (b) **Choice (iii).** Direct substitution of $x = -1$ into $f(x)$ gives the undefined expression “ $\frac{-6}{0}$ ”, indicating a vertical asymptote at $x = -1$.
- (c) **Choice (i).** We see that $\lim_{x \rightarrow 3} f(x) = \lim_{x \rightarrow 3} \left(\frac{x+2}{x(x+1)} \right) = \frac{5}{12}$. Since this limit exists, f has a removable discontinuity at $x = 3$.

12 p

257. Let $f(x) = \frac{8 + 6e^x}{9e^x - \pi^6}$.

- (a) Evaluate $\lim_{x \rightarrow \infty} f(x)$. (b) Evaluate $\lim_{x \rightarrow -\infty} f(x)$. (c) List all vertical asymptotes of f .

Solution

- (a) Divide each term by e^x and recall that $\lim_{x \rightarrow \infty} e^{-x} = 0$.

$$\lim_{x \rightarrow \infty} \left(\frac{8 + 6e^x}{9e^x - \pi^6} \right) = \lim_{x \rightarrow \infty} \left(\frac{8e^{-x} + 6}{9 - \pi^6 e^{-x}} \right) = \frac{0 + 6}{9 - 0} = \frac{2}{3}$$

- (b) Recall that $\lim_{x \rightarrow -\infty} e^x = 0$.

$$\lim_{x \rightarrow -\infty} \left(\frac{8 + 6e^x}{9e^x - \pi^6} \right) = \frac{8 + 0}{0 - \pi^6} = -\frac{8}{\pi^6}$$

- (c) The denominator vanishes if $x = \ln\left(\frac{\pi^6}{9}\right)$, and the numerator does not vanish at this x -value. Hence the only vertical asymptote of f is the line $x = \ln\left(\frac{\pi^6}{9}\right)$.

Midterm Exam #2

- 9 p** 258. The following limit represents the derivative of a function f at a point a .

$$f'(a) = \lim_{h \rightarrow 0} \left(\frac{9 \tan\left(\frac{\pi}{6} + h\right) - \frac{9}{\sqrt{3}}}{h} \right)$$

- (a) Find a possible pair for f and a .
 (b) Calculate the value of the limit.

Solution

- (a) Recall that the definition of the derivative is:

$$f'(a) = \lim_{h \rightarrow 0} \left(\frac{f(a+h) - f(a)}{h} \right)$$

Let $f(x) = 9 \tan(x)$ and let $a = \frac{\pi}{6}$. Then the given limit is $f'(a)$.

- (b) Observe that $f'(x) = 9 \sec(x)^2$, and so the given limit is $9 \sec\left(\frac{\pi}{6}\right)^2 = 9 \cdot \frac{4}{3} = 12$.

- 12 p** 259. For each part, use the graph of $y = f(x)$ to determine whether the value exists. If the value exists, state its sign (negative, positive, or zero).

- (a) $f'(1)$ (b) $f'(2)$ (c) $f'(3.5)$ (d) $f'(7)$

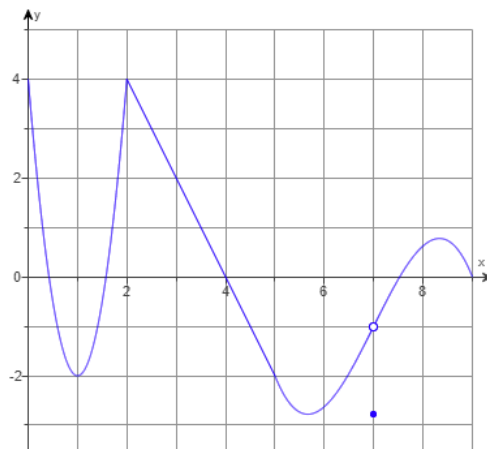
**Solution**

- (a) zero
 (b) $f'(2)$ does not exist (the graph of f has a sharp corner at $x = 2$)
 (c) negative
 (d) $f'(7)$ does not exist (f is not continuous at $x = 7$)

- 9 p** 260. Let $f(x) = x^9 e^{4x}$.

- (a) Find $f'(x)$.
 (b) Explain how to find where the tangent line to the graph of f is horizontal.
 (c) Find where the graph of f has a horizontal tangent line.

Solution

(a) Use product rule and chain rule.

$$f'(x) = 9x^8 e^{4x} + x^9 \cdot 4e^{4x} = x^8 e^{4x}(9 + 4x)$$

(b) We must solve the equation $f'(x) = 0$ for x .

(c) The solutions to $f'(x) = 0$ are $x = 0$ and $x = -\frac{9}{4}$, thus these are the x -values where f has a horizontal tangent line.

9 p

261. Selected values of the functions f and g and their derivatives are given in the table below. Use these values to complete the questions.

x	1	2	3	4
$f(x)$	4	3	2	1
$f'(x)$	-4	-1	-9	-3
$g(x)$	2	1	3	4
$g'(x)$	1	2	4	5

(a) Suppose $h(x) = 5f(x) - 8g(x)$. Find $h'(1)$.

(b) Suppose $p(x) = x^2 f(x)$. Find $p'(2)$.

(c) Suppose $q(x) = f(x^2)$. Find $q'(2)$.

Solution

(a) We have $h'(x) = 5f'(x) - 8g'(x)$. Thus

$$h'(1) = 5f'(1) - 8g'(1) = 5 \cdot (-4) - 8 \cdot 1 = -28$$

(b) By product rule we have $p'(x) = 2xf(x) + x^2 f'(x)$. Thus

$$p'(2) = 2 \cdot 2 \cdot f(2) + 4 \cdot f'(2) = 4 \cdot 3 + 4 \cdot (-1) = 8$$

(c) By chain rule we have $q'(x) = f'(x^2) \cdot 2x$. Thus

$$q'(2) = f'(4) \cdot 2 \cdot 2 = (-3) \cdot 4 = -12$$

12 p

262. Let $f(x)$ and $g(x)$ be functions such that $f'(-8) = g'(-8)$ and the line tangent to the graph of f at $x = -8$ is $y = -7x + 6$. For each part, compute the desired value, if possible.

(a) $f(-8)$

(b) $f'(-8)$

(c) $g(-8)$

(d) $g'(-8)$

Solution

(a) The tangent line to f at a point passes through the graph of f at the point of tangency. So $f(-8)$ is equal to the y -coordinate of the tangent line at $x = -8$. Thus $f(-8) = -7 \cdot (-8) + 6 = 62$.

(b) The slope of the tangent line to f is the derivative of f at the point of tangency. Hence $f'(-8)$ is -7 , the slope of the line $y = -7x + 6$.

(c) We are not given enough information to determine $g(8)$. (In particular, the slope of the tangent line to g at $x = -8$ is -7 also, but the y -intercept need not be 6. In other words,

- the point of tangency need not be the same for both f and g .)
- (d) We are given that $f'(-8) = g'(-8)$, whence $g'(-8) = -7$.

- 15 p** **263.** Consider the curve defined by the following equation, where A and B are unspecified constants.

$$Ax^2 - 8xy = B \cos(y) + 3$$

- (a) Find a formula for $\frac{dy}{dx}$.
- (b) Suppose the point $(8, 0)$ is on the curve. Find an equation that A and B must satisfy.
- (c) Suppose the tangent line to the curve at the point $(8, 0)$ is $y = 6x - 48$. Find the values of A and B .

Solution

- (a) Using implicit differentiation, we obtain:

$$2Ax - 8y - 8x \frac{dy}{dx} = -B \sin(y) \frac{dy}{dx}$$

Solving for $\frac{dy}{dx}$ gives:

$$\frac{dy}{dx} = \frac{2Ax - 8y}{8x - B \sin(y)}$$

- (b) The point $(8, 0)$ must satisfy the equation that defines the curve, whence:

$$64A = B + 3$$

- (c) We have that $\frac{dy}{dx} = 6$ (the slope of the tangent line) when $x = 8$ and $y = 0$. Hence by part (a) we have:

$$7 = \frac{16A - 0}{64 - 0} = \frac{A}{4}$$

Hence $A = 28$. From part (b) we then have $B = 64A - 3 = 1533$.

- 12 p** **264.** The base of a right triangle is decreasing at a constant rate of 10 cm/sec and in such a way that the triangle always remains a right triangle. At the time when the base is 15 cm and the height is 22 cm, the area of the triangle is increasing by 25 cm²/sec. Use this information to answer the questions below. Let B denote the base of the triangle.

- (a) At the described time, what is the sign of $\frac{dB}{dt}$?
- (b) At the described time, what is the sign of $\frac{d^2B}{dt^2}$?
- (c) At the described time, at what rate is the height changing?
- (d) What are the units of the answer to part (c)?

Solution

- (a) We are given that the base is decreasing at the given time, so $\frac{dB}{dt}$ is negative.
- (b) We are given that $\frac{dB}{dt}$, the rate at which the base is changing, is constant. Thus $\frac{d^2B}{dt^2}$ is zero.
- (c) At any time we have $A = \frac{1}{2}BH$, where A , B , and H are the area, base, and height of the triangle, respectively. Differentiating with respect to time gives us a total of two equations

that hold for any time.

$$A = \frac{1}{2}BH$$

$$\frac{dA}{dt} = \frac{1}{2} \frac{dB}{dt} H + \frac{1}{2} B \frac{dH}{dt}$$

At the given time, we have: $\frac{dB}{dt} = -10$, $B = 15$, $H = 22$, and $\frac{dA}{dt} = 25$. Substituting this information into the previous two equations gives us two equations that hold only at the described time.

$$A = 165$$

$$25 = -110 + 7.5 \frac{dH}{dt}$$

Solving for $\frac{dH}{dt}$ gives $\frac{dH}{dt} = 18$.

(d) The units of $\frac{dH}{dt}$ are cm/sec.

12 p 265. Suppose f is differentiable at x and $g(x) = \frac{16 \ln(15x)}{6f(x) - \sqrt{x+17}}$. Find $g'(x)$.

Solution

We start with quotient rule since the expression for $g(x)$ is a quotient. When we differentiate the numerator we must use chain rule.

$$g'(x) = \frac{(16 \cdot \frac{1}{15x} \cdot 15) \cdot (6f(x) - \sqrt{x+17}) - (16 \ln(15x)) \cdot (6f'(x) - \frac{1}{2\sqrt{x+7}})}{(6f(x) - \sqrt{x+7})^2}$$

Midterm Exam #3

- 20 p** 266. Find the absolute extreme values of $f(x) = x^3 - 6x^2 + 9x + 20$ on $[-3, 2]$ and the x -value(s) at which they occur.

Solution

Since f is differentiable for all x , the only critical points are solutions to $f'(x) = 0$. We have

$$f'(x) = 3x^2 - 12x + 9 = 3(x - 1)(x - 3)$$

Hence the only critical point is $x = 1$. (We reject the solution $x = 3$ since it is not in the given interval.) We now check the critical values and the endpoint values: $f(-3) = -88$, $f(1) = 24$, and $f(2) = 22$. Hence the absolute minimum is -88 (occurring at $x = -3$) and the absolute maximum is 24 (occurring at $x = 1$).

- 20 p** 267. Consider the function f and its derivatives below.

$$f(x) = \frac{x - 3}{x^2 - 6x - 16}, \quad f'(x) = \frac{-(x - 3)^2 - 25}{(x^2 - 6x - 16)^2}, \quad f''(x) = \frac{2(x - 3)((x - 3)^2 + 75)}{(x^2 - 6x - 16)^3}$$

Find where f is concave down and where f is concave up; write your answers using interval notation. Also find the x -coordinate of each inflection point of f .

Write "NONE" as your answer if appropriate. Where applicable, give a comma-separated list of intervals that are as inclusive as possible.

Solution

We calculate a sign chart for the second derivative: The cut points are the solutions to $f''(x) = 0$ ($x = 3$) and the vertical asymptotes (solutions to $x^2 - 6x - 16 = 0$, or $x = -2$ and $x = 8$).

interval	test point	sign of f''	shape of f
$(-\infty, -2)$	$f''(-3)$	$\frac{2\ominus\oplus}{\oplus} = \ominus$	concave down
$(-2, 3)$	$f''(0)$	$\frac{2\oplus\oplus}{\ominus} = \oplus$	concave up
$(3, 8)$	$f''(4)$	$\frac{2\oplus\oplus}{\ominus} = \ominus$	concave down
$(8, \infty)$	$f''(9)$	$\frac{2\oplus\oplus}{\oplus} = \oplus$	concave up

Hence we deduce the following about f :

$$\begin{aligned} f \text{ is concave down on: } & (-\infty, 2), [3, 8) \\ f \text{ is concave up on: } & (-2, 3], (8, \infty) \\ f \text{ has an infl. point at: } & x = 3 \end{aligned}$$

- 20 p** 268. Suppose f is differentiable on $(-\infty, 1) \cup (1, \infty)$ and satisfies all of the following properties. Sketch a possible graph of $y = f(x)$ on the axes provided. Label all asymptotes, local extrema, and inflection points. Your graph need not to be to scale, but it must have the correct shape.

- (i) $\lim_{x \rightarrow -\infty} f(x) = -3$; $\lim_{x \rightarrow \infty} f(x) = \infty$; $\lim_{x \rightarrow 1^-} f(x) = -\infty$; $\lim_{x \rightarrow 1^+} f(x) = \infty$;
 (ii) $f'(x) > 0$ on $(-\infty, -2)$ and $(5, \infty)$; $f'(x) < 0$ on $(-2, 1)$ and $(1, 5)$; $f'(-2) = f'(5) = 0$
 (iii) $f''(x) > 0$ on $(-\infty, -7)$ and $(1, \infty)$; $f''(x) < 0$ on $(-7, 1)$; $f''(-7) = 0$

Solution

The conditions can also be summarized as follows:

- (i) The lines $y = -3$ and $x = 1$ are horizontal and vertical asymptotes for f , respectively. There is no horizontal asymptote at positive infinity.
- (ii) f is increasing on $(-\infty, -2)$ and $(5, \infty)$; f is decreasing on $(-2, 1)$ and $(1, 5)$; there is a local minimum at $x = 5$; there is a local maximum at $x = -2$.
- (iii) f is concave up on $(-\infty, -7)$ and $(1, \infty)$; f is concave down on $(-7, 1)$; there is an inflection point at $x = -7$.

The table below summarizes the behavior of f on each subinterval.

interval	behavior of f	notes
$(-\infty, -7)$	increasing, concave up	inflection point at $x = -7$
$(-7, -2)$	increasing, concave down	local maximum at $x = -2$
$(-2, 1)$	decreasing, concave down	vertical asymptote at $x = 1$
$(1, 5)$	decreasing, concave up	local minimum at $x = 5$
$(5, \infty)$	increasing, concave up	$f \rightarrow \infty$ as $x \rightarrow \infty$

There are many possible functions that satisfy these properties. Here is one.

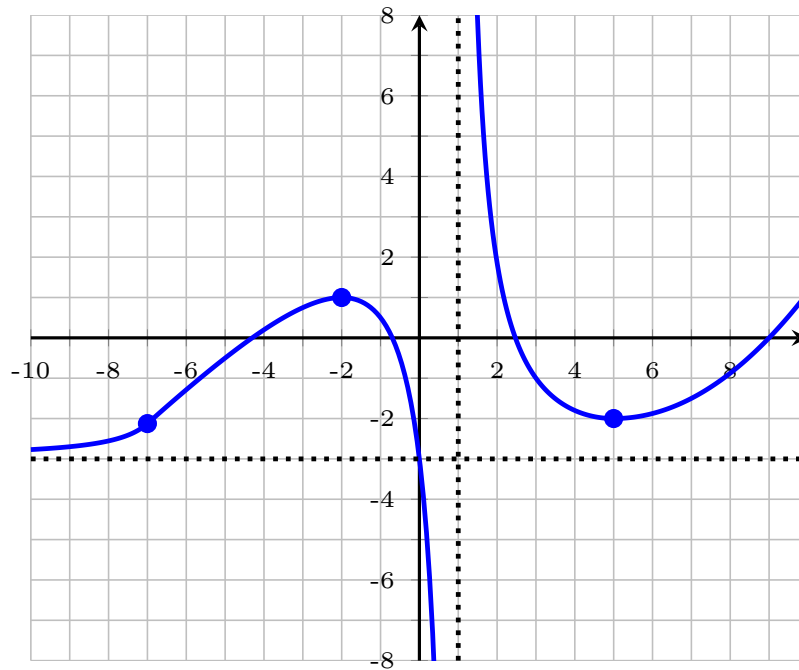

20 p

- 269.** A storage shed with a volume of 1500 ft^3 is to be built in the shape of a rectangular box with a square base. The material for the base costs $\$6/\text{ft}^2$, the material for the roof costs $\$9/\text{ft}^2$, and the material for the sides costs $\$2.50/\text{ft}^2$. Find the dimensions of the cheapest shed. As you work, fill in the answer boxes below. Let x represent the length of the base of the shed.

objective function in terms of x :	
interval of interest:	
dimensions of cheapest shed (in ft):	$\frac{\quad}{\text{length of base}} \times \frac{\quad}{\text{width of base}} \times \frac{\quad}{\text{height of shed}}$

Solution

Since we asked to find the cheapest shed, the objective function is the total cost of the shed. Let x be the length of the base of the shed and let h be the height of the shed. Since the base of the shed is a square, the total cost of the shed is

$$C = C_{\text{base}} + C_{\text{roof}} + C_{\text{sides}} = 6x^2 + 9x^2 + 2.5 \cdot 4xh = 15x^2 + 10xh$$

The volume of the shed must be 1500, whence the constraint equation is $x^2h = 1500$, and thus the height is given by $h = \frac{1500}{x^2}$. Substituting the expression for h into C gives the objective in terms of x only.

$$C(x) = 15x^2 + \frac{15000}{x}$$

Since x is a length, we must have $x \geq 0$. However, the case $x = 0$ would violate the volume constraint $x^2h = 1500$. There are no further restrictions on the allowed values of x . So the interval of interest for $C(x)$ is $(0, \infty)$. Our goal is to minimize $C(x)$ on this interval.

Since $C(x)$ is differentiable on $(0, \infty)$, the only critical points are solutions to $C'(x) = 0$. We have that $C'(x) = 30x - \frac{15000}{x^2}$, and thus the only solution to $C'(x) = 0$ is $x = 500^{1/3}$. Now observe that $C''(x) = 30 + \frac{30000}{x^3}$, which is positive for all x in $(0, \infty)$. Hence $C(x)$ is concave up on this interval, and we conclude that $x = 500^{1/3}$ does, in fact, give the absolute minimum value of $C(x)$ on $(0, \infty)$.

The dimensions of the cheapest shed are $x = 500^{1/3}$ (length of base and width of base) and $h = \frac{1500}{x^2} = 3 \cdot 500^{1/3}$ (height of shed).

20 p

270. Let $f(x) = -e^{-x}(x^2 - 5x - 23)$. Find all critical points of f . Then find where f is decreasing and where f is increasing; write your answers using interval notation. Also find where relative extrema of f occur.

Write "NONE" as your answer if appropriate. Where applicable, give a comma-separated list of intervals that are as inclusive as possible.

Solution

Since f is differentiable for all x , the only critical points are solutions to $f'(x) = 0$. Using product rule and chain rule gives

$$f'(x) = (-e^{-x} \cdot (-1))(x^2 - 5x - 23) + (-e^{-x})(2x - 5) = e^{-x}(x^2 - 7x - 18) = e^{-x}(x - 9)(x + 2)$$

Thus the critical points of f are $x = -2$ and $x = 9$. We now construct a sign chart to find the intervals of increase. (Recall that $e^{-x} > 0$ for all x .)

interval	test point	sign of f'	shape of f
$(-\infty, -2)$	$f'(-3) = \oplus\ominus\ominus$	\oplus	increasing
$(-2, 9)$	$f'(0) = \oplus\ominus\oplus$	\ominus	decreasing
$(9, \infty)$	$f'(10) = \oplus\oplus\oplus$	\oplus	increasing

Hence we deduce the following about f :

f is decreasing on: $[-2, 9]$
 f is increasing on: $(-\infty, -2], [9, \infty)$
 f has a local min at: $x = 9$
 f has a local max at: $x = -2$

1.11 Spring 2022

Precalculus Exam

12 p

271. For each part, use the graph of $y = g(x)$ given below and let $f(x) = 8x^2 - 4x + 15$.

- (a) Find an expression for $g(x)$.
 (b) Calculate the y -intercept of the graph of $y = f(g(x))$.
 (c) Calculate $g(f(x))$.

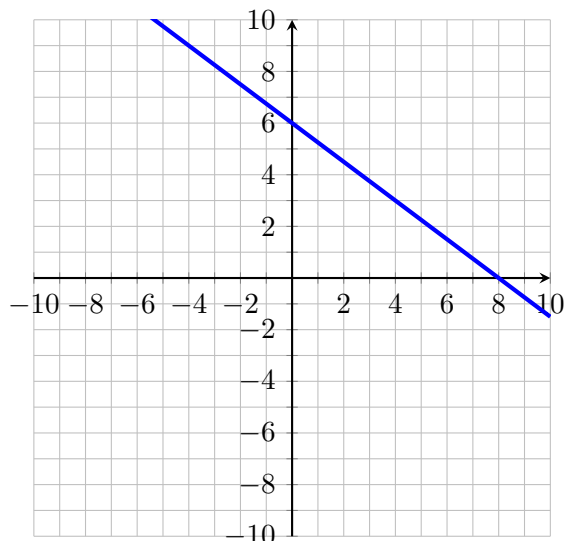
**Solution**

- (a) We observe from the figure that the graph of $y = g(x)$ is a line that passes through the points $(0, 6)$ and $(8, 0)$. Hence an equation for this line in point-slope form is

$$g(x) = 0 + \frac{0 - 6}{8 - 0}(x - 8) = -\frac{3}{4}(x - 8)$$

- (b) The desired y -intercept is the point $(0, f(g(0)))$. Note that since the y -intercept of g is $(0, 6)$, we have $g(0) = 6$. Hence $f(g(0)) = f(6) = 8 \cdot 6^2 - 4 \cdot 6 + 15 = 264$.
 (c) We have

$$g(f(x)) = -\frac{3}{4}(f(x) - 8) = -\frac{3}{4}(8x^2 - 4x + 7)$$

12 p

272. A 100-gram sample of a radioactive substance decays to 65% of its initial mass in 15 hours. Recall that the mass of the sample M at time t satisfies $M(t) = M_0 e^{kt}$ for some constants M_0 and k .

- (a) Find the growth constant k .
 (b) Find the mass of the sample after 22 hours.
 (c) Find the time in hours when the sample will have a mass of 41 grams.

Solution

- (a) We are given that $M(15) = 0.65M(0)$, which is equivalent to $M_0 e^{15k} = 0.65M_0$. Canceling the constant M_0 , taking logarithms, and solving for k gives

$$k = \frac{\ln(0.65)}{15}$$

- (b) We are given $M_0 = 100$, and so the mass at $t = 22$ is

$$M(22) = M_0 e^{22k} = 100e^{\ln(0.65)/15 \cdot 22} = 100 \cdot (0.65)^{15}$$

- (c) We must solve the equation $M(t) = 41$, or $100e^{kt} = 41$. Dividing by 100, taking logarithms, and solving for t gives

$$t = \frac{\ln(0.41)}{k} = 15 \cdot \frac{\ln(0.41)}{\ln(0.65)}$$

- 13 p** 273. A rectangular box is constructed according to the following rules.

- The length of the box is 5 times its width.
- The volume of the box is 110 cubic feet.

Let L , W , and H be the length, width, and height of the box (measured in feet), respectively.

- Write an equation in terms of L , W , and H that expresses the first constraint.
- Write an equation in terms of L , W , and H that expresses the second constraint.
- Write an expression for $S(W)$, the total surface area of the box as a function of W .
- Suppose the rules also require that the sum of the box's length and width be less than 78 feet. What is the domain of $S(W)$ in this context?

Solution

- $L = 5W$
- $LWH = 110$
- The total surface area in terms of L , and W , and H is

$$S = 2(LW + LH + WH)$$

Putting the first constraint into the second gives $5W^2H = 110$, which then gives $H = \frac{22}{W^2}$. Now substituting our expressions for L and H in terms of W into our expression for S gives

$$S(W) = 2 \left(5W \cdot W + 5W \cdot \frac{22}{W^2} + W \cdot \frac{22}{W^2} \right) = 10W^2 + \frac{264}{W}$$

- The new rule implies the constraint $L + W < 78$, or $6W < 78$ (given $L = 5W$). Hence $W < 13$. Of course, since W represents a distance, we must also have $W \geq 0$. Hence the domain of $S(W)$ in this context is $0 \leq W < 13$, or the interval $[0, 13)$.

- 12 p** 274. Suppose $\log_{16}(x) = A$ and $\log_{16}(y) = B$. Rewrite the expression below in terms of A and B . Your final answer may not contain any logarithm symbol.

$$\log_{16} \left(\frac{4x^7}{\sqrt[9]{y}} \right)$$

Solution

Using various logarithm rules and the identity $4 = 16^{1/2}$ gives the following.

$$\begin{aligned}\log_{16} \left(\frac{4x^7}{\sqrt[9]{y}} \right) &= \log_{16}(4x^7) - \log_{16}(\sqrt[9]{y}) \\ &= \log_{16}(4) + \log_{16}(x^7) - \log_{16}(y^{1/9}) \\ &= \log_{16}(16^{1/2}) + 7\log_{16}(x) - \frac{1}{9}\log_{16}(y) \\ &= \frac{1}{2} + 7A - \frac{1}{9}B\end{aligned}$$

12 p 275. Let $f(x) = \sqrt{3x}$ and assume $h \neq 0$. Fully simplify each of the following expressions:

(a) $f(x+h)$ (b) $f(x+h) - f(x)$ (c) $\frac{f(x+h) - f(x)}{h}$

Solution

- (a) $f(x+h) = \sqrt{3(x+h)}$
 (b) $f(x+h) - f(x) = \sqrt{3(x+h)} - \sqrt{3x}$
 (c) Rationalize the numerator, then simplify.

$$\frac{f(x+h) - f(x)}{h} = \frac{\sqrt{3(x+h)} - \sqrt{3x}}{h} = \frac{3(x+h) - 3x}{h(\sqrt{3(x+h)} + \sqrt{3x})} = \frac{3}{\sqrt{3(x+h)} + \sqrt{3x}}$$

12 p 276. Consider the function $f(x) = \frac{x-6}{x^2-9x+20}$.

- (a) Solve the equation $f(x) = 0$.
 (b) List all numbers that are not in the domain of $f(x)$.
 (c) Solve the inequality $f(x) > 0$ and write your answer using interval notation.

Solution

- (a) The equation $f(x) = 0$ is equivalent to $x - 6 = 0$, and so the only solution is $x = 6$.
 (b) Since $f(x)$ is rational, its domain is the set of all real numbers except where the denominator vanishes. The equation $x^2 - 9x + 20 = 0$ is equivalent to $(x - 4)(x - 5) = 0$, whence the only numbers not in the domain of $f(x)$ are $x = 4$ and $x = 5$.
 (c) We construct a sign chart whose cut points are those x -values where $f(x) = 0$ or where $f(x)$ is undefined. Hence the cut points are $x = 4$, $x = 5$, and $x = 6$. We then examine the sign of $f(x) = \frac{x-6}{(x-4)(x-5)}$ on each of the corresponding sub-intervals.

interval	test point	sign of $f(x)$	truth of inequality
$(-\infty, 4)$	$x = 0$	$\frac{\ominus}{\ominus\ominus} = \ominus$	false
$(4, 5)$	$x = 4.5$	$\frac{\oplus}{\oplus\ominus} = \oplus$	true
$(5, 6)$	$x = 5.5$	$\frac{\ominus}{\oplus\oplus} = \ominus$	false
$(6, \infty)$	$x = 7$	$\frac{\oplus}{\oplus\oplus} = \oplus$	true

None of the cut points satisfy the inequality. Hence the solution to the inequality $f(x) > 0$

is $(4, 5) \cup (6, \infty)$.

- 12 p** 277. Find all solutions to the following equation in the interval $[0, 2\pi)$.

$$2 \sin(\theta) \cos(\theta) - \cos(\theta) = 0$$

Solution

Factoring gives $\cos(\theta)(2 \sin(\theta) - 1) = 0$, whence solutions to the equation are solutions to $\cos(\theta) = 0$ or $\sin(\theta) = \frac{1}{2}$.

Recall that on the unit circle, a point (x, y) corresponds to the point $(\cos(\theta), \sin(\theta))$. Hence solving the equation $\cos(\theta) = 0$ is equivalent to solving $x = 0$ on the unit circle; we get the two solutions $\theta = \frac{\pi}{2}$ and $\theta = \frac{3\pi}{2}$. Solving the equation $\sin(\theta) = \frac{1}{2}$ is equivalent to solving $y = \frac{1}{2}$ on the unit circle; we get the two solutions $\theta = \frac{\pi}{6}$ and $\theta = \pi - \frac{\pi}{6} = \frac{5\pi}{6}$.

Hence the original equation has 4 solutions in the given interval: $\theta = \frac{\pi}{6}, \frac{\pi}{2}, \frac{5\pi}{6}, \frac{3\pi}{2}$.

- 15 p** 278. Complete each of the following algebra exercises.

- (a) Fully factor the polynomial $5x^4 + 25x^3 - 180x^2$.
 (b) Solve the rational equation below.

$$\frac{4}{x+5} + \frac{9x}{x^2-25} = \frac{6}{x-5}$$

- (c) Simplify the complex fraction below by writing it as a simple fraction.

$$\frac{\frac{4}{x} - \frac{2}{xy}}{8 + \frac{7}{y}}$$

Solution

(a) $5x^4 + 25x^3 - 180x^2 = 5x^2(x^2 + 5x - 36) = 5x^2(x+9)(x-4)$

- (b) Observe that $x^2 - 25 = (x-5)(x+5)$, hence $x^2 - 25$ serves as a common denominator for all terms. Multiplying each side of the equation by $x^2 - 25$ and canceling common factors gives

$$4(x-5) + 9x = 6(x+5)$$

Expanding each side and collecting like terms gives $7x - 50 = 0$, whence the only solution is $x = \frac{50}{7}$.

- (c) Observe that the common denominator of the terms $\frac{4}{x}$, $\frac{2}{xy}$, 8 , and $\frac{7}{y}$ is xy . We multiply the complex fraction by $\frac{xy}{xy}$ and distribute.

$$\frac{\frac{4}{x} - \frac{2}{xy}}{8 + \frac{7}{y}} \cdot \frac{xy}{xy} = \frac{4y - 2}{8xy + 7x}$$

Midterm Exam #1

10 p

279. For each part, use the graph of $y = g(x)$ below to calculate the limit or show that it does not exist. If the limit is “ $+\infty$ ” or “ $-\infty$ ”, write that as your answer, instead of “does not exist”.

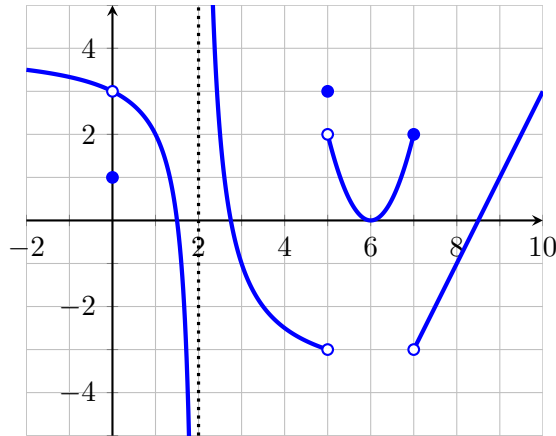

- (a) $\lim_{x \rightarrow 0} g(x)$ (b) $\lim_{x \rightarrow 2^-} g(x)$ (c) $\lim_{x \rightarrow 5^-} g(x)$ (d) $\lim_{x \rightarrow 5^+} g(x)$ (e) $\lim_{x \rightarrow 7} g(x)$

Solution

- (a) 3
 (b) $-\infty$
 (c) -3
 (d) 2
 (e) does not exist

44 p

280. For each part, calculate the limit or show that it does not exist. If the limit is “ $+\infty$ ” or “ $-\infty$ ”, write that as your answer, instead of “does not exist”.

- (a) $\lim_{x \rightarrow 3} \left(\frac{x-3}{10 - \sqrt{x+97}} \right)$ (c) $\lim_{x \rightarrow 0} \left(\frac{x^2 \csc(3x)}{\cos(7x) \sin(4x)} \right)$
 (b) $\lim_{x \rightarrow 6} \left(\frac{36 - x^2}{\frac{1}{x} - \frac{1}{6}} \right)$ (d) $\lim_{x \rightarrow 2^-} \left(\frac{6x^2 - 7x}{x^2 - 4} \right)$

Solution

- (a) Rationalize the denominator, cancel common factors, and use direct substitution.

$$\begin{aligned} \lim_{x \rightarrow 3} \left(\frac{x-3}{10 - \sqrt{x+97}} \right) &= \lim_{x \rightarrow 3} \left(\frac{x-3}{10 - \sqrt{x+97}} \cdot \frac{10 + \sqrt{x+97}}{10 + \sqrt{x+97}} \right) \\ &= \lim_{x \rightarrow 3} \left(\frac{(x-3)(10 + \sqrt{x+97})}{100 - (x+97)} \right) = \lim_{x \rightarrow 3} \left(\frac{(x-3)(10 + \sqrt{x+97})}{-(x-3)} \right) \\ &= \lim_{x \rightarrow 3} (10 + \sqrt{x+97}) = 10 + \sqrt{100} = 20 \end{aligned}$$

(b) Cancel common factors and use direct substitution.

$$\begin{aligned}\lim_{x \rightarrow 6} \left(\frac{36 - x^2}{\frac{1}{x} - \frac{1}{6}} \right) &= \lim_{x \rightarrow 6} \left(\frac{6x(36 - x^2)}{6 - x} \right) = \lim_{x \rightarrow 6} \left(\frac{6x(6 - x)(6 + x)}{6 - x} \right) \\ &= \lim_{x \rightarrow 6} (6x(6 + x)) = 36(12) = 432\end{aligned}$$

(c) Write in terms of sine and cosine, regroup terms, and use the special trigonometric limits.

$$\begin{aligned}\lim_{x \rightarrow 0} \left(\frac{x^2 \csc(3x)}{\cos(7x) \sin(4x)} \right) &= \lim_{x \rightarrow 0} \left(\frac{x}{\sin(3x)} \cdot \frac{x}{\sin(4x)} \cdot \frac{1}{\cos(7x)} \right) \\ &= \lim_{x \rightarrow 0} \left(\frac{3x}{\sin(3x)} \cdot \frac{4x}{\sin(4x)} \cdot \frac{1}{12 \cos(7x)} \right) \\ &= 1 \cdot 1 \cdot \frac{1}{12 \cdot 1} = \frac{1}{12}\end{aligned}$$

(d) Direct substitution of $x = 2$ gives the undefined expression “ $\frac{10}{0}$ ”. Since this is a nonzero number divided by zero, we know the one-sided limit is infinite, and so all we must do is sign analysis to determine the sign of the infinity. As $x \rightarrow 2$, the numerator approaches 10, so the numerator is positive. The denominator factors as $(x - 2)(x + 2)$. The second factor $(x + 2)$ goes to 4 (and is thus positive) as $x \rightarrow 2$. The first factor $(x - 2)$ goes to 0 but remains negative as $x \rightarrow 2^-$.

Putting this altogether, the expression inside the limit has a negative value ($\frac{\oplus}{\ominus \oplus} = \ominus$) as $x \rightarrow 2^-$. So the desired limit is $-\infty$.

11 p

281. Determine where $f(x)$ is continuous. *In your work, you must use limit-based methods to solve this problem. Solutions that have work that is not based on limits will not receive full credit.*

$$f(x) = \begin{cases} \frac{(x+1)^2 - 16}{2x - 6} & \text{if } x < 3 \\ 3 - \ln(x - 2) & \text{if } x \geq 3 \end{cases}$$

Solution

Each “piece” of f is obviously continuous on each of their respective open intervals. The only issue is whether f is continuous at $x = 3$. So we analyze the one-sided limits at $x = 3$. For the left-limit we expand the numerator and cancel common factors.

$$\begin{aligned}\lim_{x \rightarrow 3^-} f(x) &= \lim_{x \rightarrow 3^-} \left(\frac{(x+1)^2 - 16}{2x - 6} \right) = \lim_{x \rightarrow 3^-} \left(\frac{x^2 + 2x - 15}{2(x-3)} \right) \\ &= \lim_{x \rightarrow 3^-} \left(\frac{(x-3)(x+5)}{2(x-3)} \right) = \lim_{x \rightarrow 3^-} \left(\frac{x+5}{2} \right) = \frac{3+5}{2} = 4\end{aligned}$$

For the right-limit we use direct substitution.

$$\lim_{x \rightarrow 3^+} f(x) = \lim_{x \rightarrow 3^+} (3 - \ln(x - 2)) = 3 - \ln(1) = 3$$

Since the left- and right-limits at $x = 3$ are not equal, f is discontinuous at $x = 3$. Hence f is continuous on $(-\infty, 3) \cup (3, \infty)$.

- 11 p** 282. Find all horizontal asymptotes of the function $g(x) = \frac{2e^x - 15}{5e^{3x} + 8}$.

Solution

To find the horizontal asymptotes, we must compute the limits at infinity. For the limit at $-\infty$, recall that $\lim_{x \rightarrow -\infty} e^x = 0$. Thus we have:

$$\lim_{x \rightarrow -\infty} \left(\frac{2e^x - 15}{5e^{3x} + 8} \right) = \frac{0 - 15}{0 + 8} = -\frac{15}{8}$$

For the limit at $+\infty$, recall that $\lim_{x \rightarrow +\infty} e^{-x} = 0$. Divide each term by e^{3x} and use this special limit to obtain the following:

$$\lim_{x \rightarrow +\infty} \left(\frac{2e^x - 15}{5e^{3x} + 8} \right) = \lim_{x \rightarrow +\infty} \left(\frac{2e^{-2x} - 15e^{-3x}}{5 + 8e^{-3x}} \right) = \frac{0 - 0}{5 + 0} = 0$$

Hence the horizontal asymptotes of g are the lines $y = 0$ and $y = -\frac{15}{8}$.

- 12 p** 283. For the function f below, find its domain and all vertical and horizontal asymptotes.

$$f(x) = \frac{x^2 - 8x + 12}{3x^2 - 8x + 4}$$

Solution

Since f is a rational function, its domain is all real numbers except where the denominator vanishes. Observe that $(3x^2 - 8x + 4) = (3x - 2)(x - 2)$, hence the denominator vanishes at $x = \frac{2}{3}$ and $x = 2$. The domain of f is $(-\infty, \frac{2}{3}) \cup (\frac{2}{3}, 2) \cup (2, \infty)$.

Since f is continuous on its domain, vertical asymptotes can occur only at either $x = \frac{2}{3}$ or $x = 2$. Observe that direct substitution of $x = \frac{2}{3}$ into $f(x)$ gives an expression of " $\frac{\text{nonzero}}{0}$ ". Hence the one-sided limits of f at $x = \frac{2}{3}$ must each be infinite, and so $x = \frac{2}{3}$ is a vertical asymptote of f .

For $x = 2$, however, we have the following:

$$\lim_{x \rightarrow 2} \left(\frac{x^2 - 8x + 12}{3x^2 - 8x + 4} \right) = \lim_{x \rightarrow 2} \left(\frac{(x - 2)(x - 6)}{(3x - 2)(x - 2)} \right) = \lim_{x \rightarrow 2} \left(\frac{x - 6}{3x - 2} \right) = \frac{2 - 6}{6 - 2} = -1$$

Since this limit is finite, we conclude $x = 2$ is not a vertical asymptote of f .

For the horizontal asymptotes, we must compute the limits at infinity.

$$\lim_{x \rightarrow \pm\infty} \left(\frac{x^2 - 8x + 12}{3x^2 - 8x + 4} \right) = \lim_{x \rightarrow \pm\infty} \left(\frac{1 - \frac{8}{x} + \frac{12}{x^2}}{3 - \frac{8}{x} + \frac{4}{x^2}} \right) = \frac{1 - 0 + 0}{3 - 0 + 0} = \frac{1}{3}$$

So the only horizontal asymptote of f is the line $y = \frac{1}{3}$.

- 12 p** 284. Consider the function $f(x)$ defined below, where A and B are unspecified constants. Find the values of A and B for which f is continuous at $x = 2$, or determine that no such values exist.

$$f(x) = \begin{cases} Ax + B - 4 & \text{if } x < 2 \\ 9 & \text{if } x = 2 \\ Ax^2 - 5 & \text{if } x > 2 \end{cases}$$

In your work, you must use limit-based methods to solve this problem. Solutions that have work that is not based on limits will not receive full credit.

Solution

For f to be continuous at $x = 2$, we must have that the left-limit, right-limit, and function value at $x = 2$ are all equal. Each of these quantities is given below.

$$\lim_{x \rightarrow 2^-} f(x) = \lim_{x \rightarrow 2^-} (Ax + B - 4) = 2A + B - 4$$

$$\lim_{x \rightarrow 2^+} f(x) = \lim_{x \rightarrow 2^+} (Ax^2 - 5) = 4A - 5$$

$$f(2) = 9$$

Since these three quantities must be equal, we have the following equations.

$$2A + B - 4 = 9$$

$$4A - 5 = 9$$

The second equation gives $A = 3.5$, and back-substitution in the first equation gives $B = 6$.

Midterm Exam #2

10 p

285. For each part, use the graph of $y = f(x)$ to determine whether the value exists. If the value exists, state its sign (negative, positive, or zero).

- (a) $f'(-4)$
- (b) $f'(-2)$
- (c) $f'(0)$
- (d) $f'(5)$
- (e) $f'(8)$

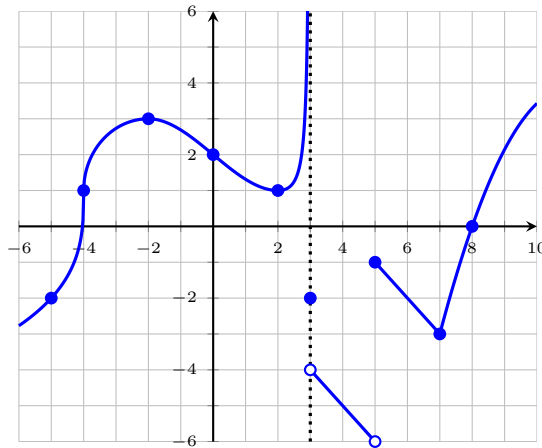
**Solution**

We have the following:

- (a) $f'(-4)$ does not exist (there is a vertical tangent at $x = -4$)
- (b) $f'(-2) = 0$ (there is a horizontal tangent at $x = -2$)
- (c) $f'(0) < 0$ (the tangent line at $x = 0$ has negative slope)
- (d) $f'(5)$ does not exist ($f(x)$ is discontinuous at $x = 5$)
- (e) $f'(8) > 0$ (the tangent line at $x = 8$ has positive slope)

30 p

286. For each part, calculate $f'(x)$. After calculating the derivative, do not simplify your answer.

- (a) $f(x) = 3x^{13} + 7\sqrt{x} - \frac{5}{x^3} + 12$
- (b) $f(x) = \frac{e^x - 2\sin(x)}{\ln(x) + x^3}$
- (c) $f(x) = 2x^4 \cos(3e^x)$

Solution

(a) We use power rule several times.

$$\frac{d}{dx} \left(3x^{13} + 7\sqrt{x} - \frac{5}{x^3} + 12 \right) = 39x^{12} + \frac{7}{2}x^{-1/2} + 15x^{-4}$$

(b) We use quotient rule.

$$\frac{d}{dx} \left(\frac{e^x - 2\sin(x)}{\ln(x) + x^3} \right) = \frac{(e^x - 2\cos(x))(\ln(x) + x^3) - (e^x - 2\sin(x))\left(\frac{1}{x} + 3x^2\right)}{(\ln(x) + x^3)^2}$$

(c) We use product rule, then chain rule.

$$\frac{d}{dx} (2x^4 \cos(3e^x)) = 8x^3 \cos(3e^x) + 2x^4 \cdot (-\sin(3e^x)) \cdot 3e^x$$

12 p 287. Let $h(x) = \frac{f(x^2)}{g(x)}$. Use the table of values below to calculate $h'(1)$.

x	$f(x)$	$f'(x)$	$g(x)$	$g'(x)$
1	-4	6	2	3
2	5	-2	-1	9

Solution

We first calculate $h'(x)$ using quotient rule, then chain rule.

$$h'(x) = \frac{f'(x^2) \cdot 2x \cdot g(x) - f(x^2)g'(x)}{g(x)^2}$$

Now we substitute $x = 1$ and use the table of values.

$$h'(1) = \frac{2f'(1)g(1) - f(1)g'(1)}{g(1)^2} = \frac{2 \cdot 6 \cdot 2 - (-4) \cdot 3}{2^2} = 9$$

12 p 288. For both parts below, $f(x) = \sqrt{2x+1}$.

- (a) Use the limit definition of the derivative to calculate $f'(4)$.
 (b) Find an equation for the line tangent to the graph of $y = f(x)$ at $x = 4$.

Solution

- (a) We start with the limit definition of the derivative and compute the given limit by rationalizing the numerator.

$$\begin{aligned} f'(4) &= \lim_{x \rightarrow 4} \left(\frac{f(x) - f(4)}{x - 4} \right) = \lim_{x \rightarrow 4} \left(\frac{\sqrt{2x+1} - 3}{x - 4} \right) = \lim_{x \rightarrow 4} \left(\frac{\sqrt{2x+1} - 3}{x - 4} \cdot \frac{\sqrt{2x+1} + 3}{\sqrt{2x+1} + 3} \right) \\ &= \lim_{x \rightarrow 4} \left(\frac{2(x-4)}{(x-4)(\sqrt{2x+1} + 3)} \right) = \lim_{x \rightarrow 4} \left(\frac{2}{\sqrt{2x+1} + 3} \right) = \frac{1}{3} \end{aligned}$$

- (b) Observe that $f(4) = 3$ and $f'(4) = \frac{1}{3}$. Hence the desired tangent line is:

$$y - 3 = \frac{1}{3}(x - 4)$$

12 p 289. Consider the curve described by the following equation:

$$12x^2 + 6xy + y^2 = 20$$

Find all points on the curve where the tangent line is horizontal. Write your answer as a comma-separated list of coordinate pairs.

Hint: Find a second equation that such points must satisfy.

Solution

We first differentiate each side of the given equation to find an equation for $\frac{dy}{dx}$.

$$24x + 6y + 6x \frac{dy}{dx} + 2y \frac{dy}{dx} = 0$$

At a point where the tangent line is horizontal we have $\frac{dy}{dx} = 0$, and so putting $\frac{dy}{dx} = 0$ in the above equation gives

$$24x + 6y = 0 \implies y = -4x$$

Hence any point where the tangent is horizontal must satisfy both the equation for the curve and the equation $y = -4x$. Combining these two equations gives

$$12x^2 + 6x(-4x) + (-4x)^2 = 20$$

This equation is equivalent to $4x^2 = 20$, whence $x = -\sqrt{5}$ or $x = \sqrt{5}$. Recalling that $y = -4x$ at the desired points, we find two points where the tangent line is horizontal: $(-\sqrt{5}, 4\sqrt{5})$ and $(\sqrt{5}, -4\sqrt{5})$.

12 p

- 290.** A house sits at point P , which is 20 m from point Q on a straight road. A car travels along the road toward the point Q at 19 m/s. Let x be the distance between the car and point Q , and let θ be the angle between the road and the line of sight from the car to the house. See the figure below.

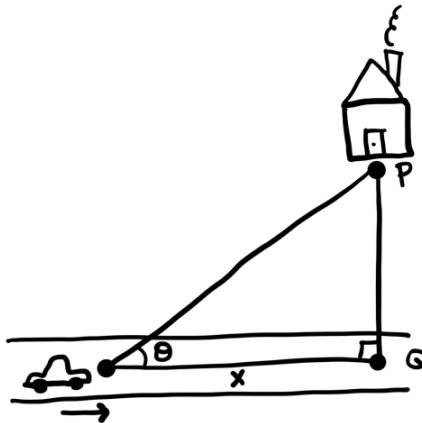

- What is the sign of $\frac{dx}{dt}$?
- What is the sign of $\frac{d\theta}{dt}$?
- Find the rate of change of the distance between the car and the house when the car is 45 m from point Q . You must include correct units in your answer. You may leave unsimplified radicals in your answer.

Solution

- Since x is decreasing, $\frac{dx}{dt}$ is negative.
- Since θ is increasing, $\frac{d\theta}{dt}$ is positive.
- Let L be the distance between the car and the house. Observe that we seek the value of $\frac{dL}{dt}$ at the time when $x = 45$.

By Pythagorean Theorem, we have $x^2 + 20^2 = L^2$, and differentiating this equation gives $2x \frac{dx}{dt} = 2L \frac{dL}{dt}$. We are given that $\frac{dx}{dt} = -19$ when $x = 45$, and so substituting this information into our two equations gives us the following:

$$\begin{aligned} 45^2 + 20^2 &= L^2 \\ -90 \cdot 19 &= 2L \frac{dL}{dt} \end{aligned}$$

The first of these last two equations gives $L = \sqrt{45^2 + 20^2}$, whence the second equation then gives

$$\frac{dL}{dt} = \frac{-45 \cdot 19}{\sqrt{45^2 + 20^2}}$$

The units of our answer are “m/s”.

12 p

291. For both parts below, suppose the line tangent to the graph of $y = f(x)$ at $x = 5$ is $y = 2x - 3$.

- (a) Calculate $f(5)$ and $f'(5)$.
 (b) Let $g(x) = xf(x) + 14$. Find an equation of the line tangent to the graph of $y = g(x)$ at $x = 5$.

Solution

- (a) The tangent line at $x = 5$ intersects the graph of $y = f(x)$ at $x = 5$, whence $f(5) = 2 \cdot 5 - 3 = 7$. The slope of the tangent line at $x = 5$ is $f'(5)$, whence $f'(5) = 2$.
 (b) First observe that, by part (a), $g(5) = 5f(5) + 14 = 49$. Then using product rule, we obtain $g'(x) = f(x) + xf'(x)$. Putting $x = 5$ and using part (a) again, we now have $g'(5) = f(5) + 5f'(5) = 17$. Hence the desired tangent line is:

$$y - 49 = 17(x - 5)$$

Midterm Exam #3

20 p

292. For each part, calculate the limit or show that it does not exist. If the limit is “ $+\infty$ ” or “ $-\infty$ ”, write that as your answer, instead of “does not exist”.

(a) $\lim_{x \rightarrow \pi} \left(\frac{\cos(6x) - 1}{(x - \pi)^2} \right)$

(b) $\lim_{x \rightarrow 0} (e^{2x} + 3x)^{1/x}$

Solution

(a) Direct substitution of $x = \pi$ gives “ $\frac{0}{0}$ ”. So we use l’Hospital’s Rule (twice).

$$\lim_{x \rightarrow \pi} \left(\frac{\cos(6x) - 1}{(x - \pi)^2} \right) \stackrel{H}{=} \lim_{x \rightarrow \pi} \left(\frac{-6 \sin(6x)}{2(x - \pi)} \right) \stackrel{H}{=} \lim_{x \rightarrow \pi} \left(\frac{-36 \cos(6x)}{2} \right) = \frac{-36 \cdot 1}{2} = -18$$

(b) Direct substitution of $x = 0$ gives “ 1^∞ ”. We let L be the desired limit, take logarithms, and use l’Hospital’s Rule.

$$\begin{aligned} \ln(L) &= \lim_{x \rightarrow 0} \ln \left((e^{2x} + 3x)^{1/x} \right) = \lim_{x \rightarrow 0} \left(\frac{\ln(e^{2x} + 3x)}{x} \right) \\ &\stackrel{H}{=} \lim_{x \rightarrow 0} \left(\frac{\frac{1}{e^{2x} + 3x} \cdot (2e^{2x} + 3)}{1} \right) = \frac{2 + 3}{1 + 0} = 5 \end{aligned}$$

We find that $\ln(L) = 5$, whence $L = e^5$.

15 p

293. Let $f(x) = 4x^5 - 20x^4 + 7x + 32$. Find where f is concave down and where f is concave up; write your answer using interval notation. Also find where inflection points of f occur.

Solution

We first compute the second derivative of f .

$$f'(x) = 20x^4 - 80x^3 + 7$$

$$f''(x) = 80x^3 - 240x^2 = 80x^2(x - 3)$$

We now calculate a sign chart for the second derivative: The cut points are the solutions to $f''(x) = 0$ ($x = 0$ and $x = 3$).

interval	test point	sign of f''	shape of f
$(-\infty, 0)$	$f''(-1)$	$\oplus \ominus = \ominus$	concave down
$(0, 3)$	$f''(1)$	$\oplus \ominus = \ominus$	concave down
$(3, \infty)$	$f''(4)$	$\oplus \oplus = \oplus$	concave up

Hence we deduce the following about f :

f is concave down on: $(-\infty, 3]$

f is concave up on: $[3, \infty)$

f has an infl. point at: $x = 3$

- 10 p** 294. Suppose $f(x)$ satisfies all of the following properties. Sign charts for f' and f'' are also given below. Sketch a possible graph of $y = f(x)$ on the axes provided. Label all asymptotes, local extrema, and inflection points. Your graph need not be to scale, but it must have the correct shape.

- (i) f is continuous and differentiable on $(-\infty, 2) \cup (2, \infty)$
 (ii) $\lim_{x \rightarrow -\infty} f(x) = \infty$; $\lim_{x \rightarrow \infty} f(x) = \infty$; $\lim_{x \rightarrow 2^-} f(x) = -\infty$; $\lim_{x \rightarrow 2^+} f(x) = \infty$
 (iii) the only x -value for which $f'(x) = 0$ is $x = 5$
 (iv) the only x -value for which $f''(x) = 0$ is $x = -3$

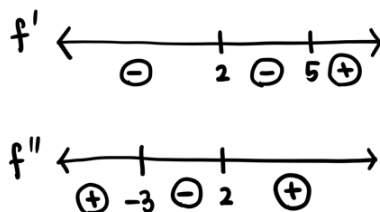

- 15 p** 295. Let $f(x) = \frac{x^2 + 21}{x - 2}$. Find where f is decreasing and where f is increasing; write your answer using interval notation. Also find where the local extrema of f occur.

Write “NONE” as your answer if appropriate. Where applicable, give a comma-separated list of intervals that are as inclusive as possible.

Solution

We first compute the first derivative of f .

$$f'(x) = \frac{2x(x-2) - (x^2+21) \cdot 1}{(x-2)^2} = \frac{x^2 - 4x - 21}{(x-2)^2} = \frac{(x+3)(x-7)}{(x-2)^2}$$

We calculate a sign chart for the first derivative. The cut points are the solutions to $f'(x) = 0$ ($x = -3$ and $x = 7$) and the vertical asymptotes ($x = 2$).

interval	test point	sign of f'	shape of f
$(-\infty, -3)$	$f'(-4)$	$\frac{\ominus \ominus}{\oplus} = \oplus$	increasing
$(-3, 2)$	$f'(0)$	$\frac{\oplus \ominus}{\oplus} = \ominus$	decreasing
$(2, 7)$	$f'(3)$	$\frac{\oplus \ominus}{\oplus} = \ominus$	decreasing
$(7, \infty)$	$f'(8)$	$\frac{\oplus \oplus}{\oplus} = \oplus$	increasing

Hence we deduce the following about f :

$$\begin{aligned} f \text{ is decreasing on:} & \quad [-3, 2), (2, 7] \\ f \text{ is increasing on:} & \quad (-\infty, -3], [7, \infty) \\ f \text{ has a local min at:} & \quad x = 7 \\ f \text{ has a local max at:} & \quad x = -3 \end{aligned}$$

- 20 p** 296. Find the absolute extreme values of $f(x) = x(x-8)^{5/3}$ on the interval $[0, 9]$ and the x -values at which they occur.

Solution

We first find the critical points of f . Observe the following:

$$f'(x) = 1 \cdot (x-8)^{5/3} + x \cdot \frac{5}{3}(x-8)^{2/3} = \frac{8}{3}(x-8)^{2/3}(x-3)$$

The critical points of f are where $f'(x)$ does not exist (nowhere) or where $f'(x) = 0$ ($x = 3$ and $x = 8$ only). We now compare the endpoint values and critical values.

x	0	3	8	9
$f(x)$	0	$-3 \cdot 5^{5/3}$	0	9

Hence the absolute minimum is $-3 \cdot 5^{5/3}$ at $x = 3$ and the absolute maximum is 9 at $x = 9$.

20 p

- 297.** A rectangle (with base B and height H) is constructed with its base on the diameter of a semicircle with radius 5 and with its two other vertices on the semicircle. Find the dimensions of the rectangle with the maximum possible area.

As you work, fill in the answer boxes below. You must use calculus-based methods in your work. You must also justify that your answer really does give the maximum.

constraint equation in terms of B and H :	
objective function in terms of H only:	
interval of interest:	
dimensions of rectangle:	$\frac{\quad}{B \text{ (base)}} \times \frac{\quad}{H \text{ (height)}}$

Solution

We wish to maximize the area of the rectangle, whence the objective function is $A(B, H) = BH$. By Pythagorean Theorem (see the figure), we have the constraint equation $(B/2)^2 + H^2 = 25$. Solving for B in terms of H gives $B = 2\sqrt{25 - H^2}$, whence the objective function in terms of H only is:

$$f(H) = 2H\sqrt{25 - H^2}$$

The interval of interest (allowed values of H) is $[0, 5]$. We now find the derivative of f to find the critical points.

$$f'(H) = 2\sqrt{25 - H^2} + 2H \cdot \frac{-2H}{2\sqrt{25 - H^2}} = 2\sqrt{25 - H^2} - \frac{2H^2}{\sqrt{25 - H^2}}$$

We now solve the equation $f'(H) = 0$.

$$\begin{aligned}2\sqrt{25 - H^2} - \frac{2H^2}{\sqrt{25 - H^2}} &= 0 \\2(25 - H^2) - 2H^2 &= 0 \\H &= \frac{5}{\sqrt{2}}\end{aligned}$$

We now verify that this critical point gives the absolute maximum of f . Observe that since the interval of interest is closed and bounded, we can simply compare the endpoint values and critical values. We clearly have $f(0) = f(5) = 0$ and $f(H) > 0$ at the critical point. Hence the absolute maximum does, indeed, occur at the critical point.

The dimensions of the desired rectangle are $H = \frac{5}{\sqrt{2}}$ and $B = 2\sqrt{25 - H^2} = 5\sqrt{2}$.

1.12 Summer 2022

Precalculus Exam

28 p 298. Complete each of the following algebra exercises.

- (a) Simplify $\left(\frac{27x^{3/5}}{x^{-3}z^{15}}\right)^{-1/3}$, leaving positive exponents and integer coefficients.
- (b) Simplify $\frac{x^2 - 9}{3 - \sqrt{6 - x}}$ for $x \neq -3$. (All common factors must be canceled.)
- (c) Factor the expression completely: $5x^9 - 14x^8 - 3x^7$.
- (d) Fully simplify the difference quotient $\frac{f(x+h) - f(x)}{h}$ for $f(x) = \frac{2}{x} - 3$ and $h \neq 0$.

Solution

(a) We have the following:

$$\left(\frac{27x^{3/5}}{x^{-3}z^{15}}\right)^{-1/3} = \frac{27^{-1/3}x^{-1/5}}{xz^{-5}} = \frac{z^5}{3x^{6/5}}$$

(b) Rationalize the denominator. Then cancel common factors.

$$\begin{aligned} \frac{x^2 - 9}{3 - \sqrt{6 - x}} &= \frac{x^2 - 9}{3 - \sqrt{6 - x}} \cdot \frac{3 + \sqrt{6 - x}}{3 + \sqrt{6 - x}} = \frac{(x - 3)(x + 3)(3 + \sqrt{6 - x})}{9 - (6 - x)} \\ &= \frac{(x - 3)(x + 3)(3 + \sqrt{6 - x})}{3 + x} = (x - 3)(3 + \sqrt{6 - x}) \end{aligned}$$

(c) We have the following:

$$5x^9 - 14x^8 - 3x^7 = x^7(5x^2 - 14x - 3) = x^7(5x + 1)(x - 3)$$

(d) Multiply all terms by the LCD $x(x+h)$, and cancel common factors.

$$\begin{aligned} \frac{f(x+h) - f(x)}{h} &= \frac{\frac{2}{x+h} - 3 - \left(\frac{2}{x} - 3\right)}{h} = \frac{\frac{2}{x+h} - \frac{2}{x}}{h} \cdot \frac{x(x+h)}{x(x+h)} \\ &= \frac{2x - 2(x+h)}{hx(x+h)} = \frac{2x - 2x - 2h}{hx(x+h)} = \frac{-2h}{hx(x+h)} = \frac{-2}{x(x+h)} \end{aligned}$$

24 p 299. For each part, find all solutions to the given equation.

- (a) $\sqrt{2x+1} + 1 = x$
- (b) $(10 - x^2)^{1/2} - x^2(10 - x^2)^{-1/2} = 0$
- (c) $2 + \sin(\theta) = 2 \cos(\theta)^2$ (find solutions in $[0, 2\pi)$ only)

Solution

- (a) Subtract 1 from either side, square both sides, and solve for
- x
- .

$$\begin{aligned}\sqrt{2x+1} + 1 &= x \\ \sqrt{2x+1} &= x - 1 \\ 2x + 1 &= (x - 1)^2 = x^2 - 2x + 1 \\ x^2 - 4x &= 0 \\ x(x - 4) &= 0\end{aligned}$$

Hence we obtain candidate solutions of $x = 0$ and $x = 4$. However, checking these candidates in the original equation, we see that only $x = 4$ is a solution.

- (b) Multiply all terms by
- $(10 - x^2)^{1/2}$
- , and then solve for
- x
- .

$$\begin{aligned}(10 - x^2)^{1/2} - x^2(10 - x^2)^{-1/2} &= 0 \\ (10 - x^2)^1 - x^2 \cdot 1 &= 0 \\ 10 &= 2x^2 \\ x = \sqrt{5} \quad \text{or} \quad x = -\sqrt{5}\end{aligned}$$

- (c) Use the Pythagorean identity on the right side, then rearrange and factor.

$$\begin{aligned}2 + \sin(\theta) &= 2 \cos(\theta)^2 \\ 2 + \sin(\theta) &= 2(1 - \sin(\theta)^2) \\ 2 + \sin(\theta) &= 2 - 2 \sin(\theta)^2 \\ 2 \sin(\theta)^2 + \sin(\theta) &= 0 \\ \sin(\theta)(2 \sin(\theta) + 1) &= 0\end{aligned}$$

Hence we have two possible equations to solve: $\sin(\theta) = 0$ (which has solutions $\theta = 0$ and $\theta = \pi$ in the given interval) and $\sin(\theta) = -\frac{1}{2}$ (which has solutions $\theta = \frac{7\pi}{6}$ and $\theta = \frac{11\pi}{6}$ in the given interval). So there are four solutions in total.

- 8 p** 300. Find the domain of the function $f(x) = \ln(x^2 - 20)$. Write your answer using interval notation.

Solution

The domain of $f(x)$ consists of those x -values such that $x^2 - 20 > 0$. To solve this non-linear inequality, we find the cut points: solutions to $x^2 - 20 = 0$, or $x = -\sqrt{20}$ and $x = \sqrt{20}$. We then make a sign chart, testing each of the following intervals: $(-\infty, -\sqrt{20})$, $(-\sqrt{20}, \sqrt{20})$, and $(\sqrt{20}, \infty)$.

For these three intervals, we use the test points -5 , 0 , and 5 , respectively. Hence we find that $x^2 - 20$ is positive on the first and third of these intervals only. Hence the domain of $f(x)$ is $(-\infty, -\sqrt{20}) \cup (\sqrt{20}, \infty)$.

- 8 p** 301. The length of a rectangular box is three times its width, and the total surface area of the box is 200 in². Let W be the width of the box in inches. Find the volume of the box in terms of W .

Solution

Let L , W , and H be the length, width, and height of the box, respectively. Then we immediately have $L = 3W$. For the surface area we have:

$$2(LW + LH + WH) = 200$$

Substituting $L = 3W$ into this equation and collecting like terms gives:

$$3W^2 + 4WH = 100$$

Solving for H then gives:

$$H = \frac{100 - 3W^2}{4W}$$

Hence the volume of the box is

$$V = LWH = 3W \cdot W \cdot \frac{100 - 3W^2}{4W} = \frac{3}{4}(100W - 3W^3)$$

12 p

302. For each part, write an equation for the line in the xy -plane that satisfies the given description.

- The line through the point $(-2, 10)$ with slope -3 .
- The line through the points $(3, 5)$ and $(-1, 4)$.
- The line through the point $(5, 1)$ and perpendicular to the line $x + 3y = 10$.
- The horizontal line through the point $(-2, 15)$.

Solution

Use point-slope form for all answers.

- $y - 10 = -3(x + 2)$
- The slope of the line is $m = \frac{4-5}{-1-3} = \frac{1}{4}$, hence an equation of the line is $y - 5 = \frac{1}{4}(x - 3)$.
- The given line can be written as $y = -\frac{1}{3}x + \frac{10}{3}$, whence the slope of the given line is $-\frac{1}{3}$, and so the slope of the desired line is 3 . Hence an equation of the desired line is $y - 1 = 3(x - 5)$.
- $y = 15$

8 p

303. The number of bacteria in a certain colony grows exponentially. Recall that this means the number of bacteria N at time t is $N(t) = N_0e^{kt}$, where N_0 and k are constants. Suppose there are initially 500 bacteria, and the number of bacteria triples every 2 hours. How much time must pass before the number of bacteria increases from 500 to 5000?

Solution

Let $N(t) = N_0e^{kt}$ be the number of bacteria at time t (measured in hours). Then we have that $N(2) = 3N_0$, or $N_0e^{2k} = 3N_0$. Canceling N_0 and solving for k gives:

$$k = \frac{1}{2} \ln(3)$$

Now we want to find the value of T such that $N(T) = 5000$, with $N_0 = 500$. Hence we must solve the equation $5000 = 500e^{kT}$, where k is the value we found previously. We obtain:

$$T = 2 \cdot \frac{\ln(10)}{\ln(3)}$$

12 p 304. For each part, use the graphs of $y = f(x)$ and $y = g(x)$ below.

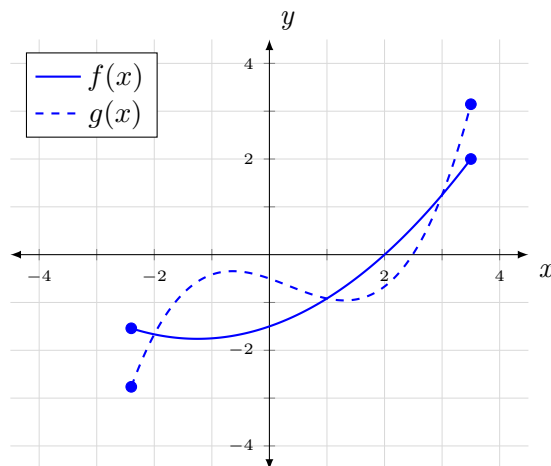

- Calculate $f(2)$.
- Estimate the value of $g(0) - f(0)$.
- Find all solutions to the equation $f(x) = g(x)$.
- Solve the inequality $g(x) > f(x)$. Write your answer using interval notation.

Solution

- $f(2) = 0$
- $g(0) - f(0) = 1$
- The solutions are the x -values of the points where the graphs intersect: $x = -2, 1, 3$.
- The solution is the set of x -values where the graph of g lies above that of f : $(-2, 1) \cup (3, 3.5]$.

Midterm Exam #1

27 p

305. For each part, calculate the limit or show that it does not exist. If the limit is “ $+\infty$ ” or “ $-\infty$ ”, write that as your answer, instead of “does not exist”.

$$(a) \lim_{x \rightarrow 5} \left(\frac{6x + 10}{x^2 - 25} - \frac{4}{x - 5} \right) \quad (b) \lim_{x \rightarrow 6} \left(\frac{x - \sqrt{5x + 6}}{6 - x} \right) \quad (c) \lim_{x \rightarrow \infty} \left(\frac{5e^{2x} - 3e^x}{9e^{3x} - 12} \right)$$

Solution

(a) Find a common denominator, factor, and then cancel common factors.

$$\begin{aligned} \lim_{x \rightarrow 5} \left(\frac{6x + 10}{x^2 - 25} - \frac{4}{x - 5} \right) &= \lim_{x \rightarrow 5} \left(\frac{6x + 10 - 4(x + 5)}{x^2 - 25} \right) = \\ &= \lim_{x \rightarrow 5} \left(\frac{2(x - 5)}{(x - 5)(x + 5)} \right) = \lim_{x \rightarrow 5} \left(\frac{2}{x + 5} \right) = \frac{2}{10} = \frac{1}{5} \end{aligned}$$

(b) Rationalize the numerator, then cancel common factors.

$$\begin{aligned} \lim_{x \rightarrow 6} \left(\frac{x - \sqrt{5x + 6}}{6 - x} \cdot \frac{x + \sqrt{5x + 6}}{x + \sqrt{5x + 6}} \right) &= \lim_{x \rightarrow 6} \left(\frac{x^2 - (5x + 6)}{(6 - x)(x + \sqrt{5x + 6})} \right) = \\ &= \lim_{x \rightarrow 6} \left(\frac{(x - 6)(x + 1)}{(6 - x)(x + \sqrt{5x + 6})} \right) = \lim_{x \rightarrow 6} \left(\frac{-(x + 1)}{x + \sqrt{5x + 6}} \right) = -\frac{7}{12} \end{aligned}$$

(c) The dominant term of the denominator is e^{3x} . So divide all terms by e^{3x} and take limits.

$$\lim_{x \rightarrow \infty} \left(\frac{5e^{2x} - 3e^x}{9e^{3x} - 12} \right) = \lim_{x \rightarrow \infty} \left(\frac{5e^{-x} - e^{-2x}}{9 - 12e^{-3x}} \right) = \frac{0 - 0}{9 - 0} = 0$$

12 p

306. Consider the function $f(x) = \frac{\sin(7x)}{x^2 - 5x}$.

- Find the domain of f . Write your answer using interval notation.
- Find the x -values where f is discontinuous.
- For each value of x where f is discontinuous, classify the type of discontinuity as “removable”, “jump”, “infinite”, or “essential”. Clearly label your work and justify your answers.

Solution

- The domain of f is all real numbers except where $x^2 - 5x = 0$ (i.e., $x = 0$ or $x = 5$). Hence the domain of f is $(-\infty, 0) \cup (0, 5) \cup (5, \infty)$.
- Since f is a quotient of continuous functions, f is continuous for all x except where the denominator is 0. Hence f is discontinuous at both $x = 0$ and $x = 5$.
- Substitution of $x = 5$ into f gives the undefined expression “ $\frac{\sin(35)}{0} = \frac{\text{nonzero} \#}{0}$ ”. Hence $x = 5$ is a vertical asymptote for f , and so f has an infinite discontinuity at $x = 5$.

For $x = 0$, we have the following:

$$\lim_{x \rightarrow 0} f(x) = \lim_{x \rightarrow 0} \left(\frac{\sin(7x)}{x} \cdot \frac{1}{x - 5} \right) = \lim_{x \rightarrow 0} \left(\frac{\sin(7x)}{7x} \cdot \frac{7}{x - 5} \right) = 1 \cdot \frac{7}{0 - 5} = -\frac{7}{5}$$

Since this limit is finite, we see that f has a removable discontinuity at $x = 0$.

12 p

307. Consider the limit $\lim_{x \rightarrow 3} \left(\frac{x^3 - 4x^2 + ax}{x^2 - 9} \right)$, where a is an unspecified constant.

- (a) For what values of a does this limit exist? Explain your answer.
 (b) Given that the limit does exist, what is its value?

Solution

- (a) Direct substitution of $x = 3$ gives the undefined expression " $\frac{-9+3a}{0}$ ". If $-9 + 3a \neq 0$, then $x = 3$ is a vertical asymptote, whence the limit could not exist. Since the limit does exist, we must have $-9 + 3a = 0$, or $a = 3$.
 (b) Put $a = 3$, factor, and cancel common factors.

$$\lim_{x \rightarrow 3} \left(\frac{x^3 - 4x^2 + 3x}{x^2 - 9} \right) = \lim_{x \rightarrow 3} \left(\frac{x(x-3)(x-1)}{(x-3)(x+3)} \right) = \lim_{x \rightarrow 3} \left(\frac{x(x-1)}{x+3} \right) = \frac{3 \cdot 2}{6} = 1$$

12 p

308. Consider the function below, where a and b are unspecified constants. Find the values of a and b for which f is continuous for all x , or determine that no such values exist.

$$f(x) = \begin{cases} ax^2 + 3x + b & x < -1 \\ 2 + ax + \sin\left(\frac{\pi x}{2}\right) & -1 \leq x < 4 \\ b(x-3)^2 + 1 & x \geq 4 \end{cases}$$

In your work, you must use limit-based methods to solve this problem. Solutions that have work that is not based on limits will not receive full credit.

Solution

Each piece of f is continuous on their respective intervals. So if f is to be continuous for all x , f must be continuous at the transition points $x = -1$ and $x = 4$.

For $x = -1$, the left-limit, right-limit, and function value must be equal.

$$\begin{aligned} \lim_{x \rightarrow -1^-} f(x) &= \lim_{x \rightarrow -1^-} (ax^2 + 3x + b) = a - 3 + b \\ \lim_{x \rightarrow -1^+} f(x) &= \lim_{x \rightarrow -1^+} \left(2 + ax + \sin\left(\frac{\pi x}{2}\right) \right) = 1 - a \\ f(-1) &= \left(2 + ax + \sin\left(\frac{\pi x}{2}\right) \right) \Big|_{x=-1} = 1 - a \end{aligned}$$

So we must have $a - 3 + b = 1 - a$, or $2a + b = 4$. For $x = 4$, the left-limit, right-limit, and function value must be equal.

$$\begin{aligned} \lim_{x \rightarrow 4^-} f(x) &= \lim_{x \rightarrow 4^-} \left(2 + ax + \sin\left(\frac{\pi x}{2}\right) \right) = 2 + 4a \\ \lim_{x \rightarrow 4^+} f(x) &= \lim_{x \rightarrow 4^+} (b(x-3)^2 + 1) = b + 1 \\ f(4) &= (b(x-3)^2 + 1) \Big|_{x=4} = b + 1 \end{aligned}$$

So we must have $2 + 4a = b + 1$, or $4a - b = -1$. Thus we must solve the simultaneous set of

equations:

$$2a + b = 4$$

$$4a - b = -1$$

Adding the equations gives $6a = 3$, whence $a = \frac{1}{2}$. Then the first equation gives $b = 3$.

13 p

309. Consider the function $f(x) = \frac{x^3 - 3x + 1}{x^2 - 2x + 1}$.

- (a) Find all horizontal asymptotes of f , if any.
 (b) Find all vertical asymptotes of f . Then calculate $\lim_{x \rightarrow a^-} f(x)$ and $\lim_{x \rightarrow a^+} f(x)$, where $x = a$ is the rightmost vertical asymptote of f .

Solution

- (a) We compute the limits of f at infinity. To this end, we factor the highest powers of numerator and denominator separately.

$$\lim_{x \rightarrow \pm\infty} \left(\frac{x^3}{x^2} \cdot \frac{1 - \frac{3}{x^2} + \frac{1}{x^3}}{1 - \frac{2}{x} + \frac{1}{x^2}} \right) = \lim_{x \rightarrow \pm\infty} \left(x \cdot \frac{1 - \frac{3}{x^2} + \frac{1}{x^3}}{1 - \frac{2}{x} + \frac{1}{x^2}} \right) = (\pm\infty) \cdot \frac{1 - 0 + 0}{1 - 0 + 0} = \pm\infty$$

These limits are not finite. Thus f has no horizontal asymptote.

- (b) Since f is a rational function, vertical asymptotes can occur only where the denominator is 0. The only solution to $x^2 - 2x + 1 = (x - 1)^2 = 0$ is $x = 1$. Substitution of $x = 1$ into f gives the undefined expression " $\frac{-1}{0} = \frac{\text{nonzero } \#}{0}$ ", whence $x = 1$ is, indeed, a vertical asymptote for f .

Now we compute the left- and right-limits using sign analysis.

$$\lim_{x \rightarrow 1^-} \left(\frac{x^3 - 3x + 1}{(x - 1)^2} \right) = \frac{-1}{0^+} = -\infty$$

$$\lim_{x \rightarrow 1^+} \left(\frac{x^3 - 3x + 1}{(x - 1)^2} \right) = \frac{-1}{0^+} = -\infty$$

(For this function, the analysis was simplified since the denominator is the perfect square $(x - 1)^2$ and thus never negative.)

24 p

310. For each part, mark "T" if the statement is true or mark "F" if the statement is false. You do not have to explain your answers or show any work.

- (a) T F If $\lim_{x \rightarrow 1} f(x)$ and $\lim_{x \rightarrow 1} g(x)$ both exist, then $\lim_{x \rightarrow 1} (f(x)g(x))$ exists.
 (b) T F If $f(9)$ is undefined, then $\lim_{x \rightarrow 9} f(x)$ does not exist.
 (c) T F If $\lim_{x \rightarrow 1^+} f(x) = 10$ and $\lim_{x \rightarrow 1} f(x)$ exists, then $\lim_{x \rightarrow 1} f(x) = 10$.
 (d) T F A function is continuous for all x if its domain is $(-\infty, \infty)$.
 (e) T F If $f(x)$ is continuous at $x = 3$, then $\lim_{x \rightarrow 3^-} f(x) = \lim_{x \rightarrow 3^+} f(x)$.
 (f) T F If $\lim_{x \rightarrow 2} f(x)$ exists, then f is continuous at $x = 2$.

- (g) If $\lim_{x \rightarrow 5^-} f(x) = -\infty$, then $\lim_{x \rightarrow 5^+} f(x) = +\infty$.
- (h) A function can have two different horizontal asymptotes.

Solution

- (a) **True.** This follows by the product law for limits.
- (b) **False.** Let $f(x) = 0$ for all x except $x = 9$, with $f(9)$ undefined. Then $\lim_{x \rightarrow 9} f(x) = 0$. (The value $f(a)$ is completely independent of the limit $\lim_{x \rightarrow a} f(x)$.)
- (c) **True.** If a two-sided limit exists, then it must be equal to the corresponding left- and right-limits.
- (d) **False.** Let $f(x) = 0$ for all x except $x = 2$, with $f(2) = 1$. Then f has domain $(-\infty, \infty)$ but is discontinuous at $x = 2$.
- (e) **True.** If f is continuous at $x = 3$, then, in particular, $\lim_{x \rightarrow 3} f(x)$ exists, which then implies the corresponding left- and right-limits at $x = 3$ are equal.
- (f) **False.** Let f be the function in part (d). Then $\lim_{x \rightarrow 2} f(x) = 0$ but f is not continuous at $x = 2$.
- (g) **False.** Let $f(x) = -\frac{1}{(x-5)^2}$. Then $\lim_{x \rightarrow 5^-} f(x) = \lim_{x \rightarrow 5^+} f(x) = -\infty$.
- (h) **True.** Let $f(x) = 0$ for $x \leq 0$ and let $f(x) = 1$ for $x > 0$. Then f has two horizontal asymptotes: $x = 0$ and $x = 1$.

Midterm Exam #2

24 p

311. For each part, calculate the derivative. After calculating the derivative, do not simplify your answer.

$$(a) \frac{d}{dx} \left(\tan \left(\frac{\ln(x)}{2x-5} \right) \right) \quad (b) \frac{d}{dx} (3x^7 \cos(x) - 8e^{3x}) \quad (c) \frac{d}{dx} \left(10x^{12} - \frac{3}{x^3} + \sqrt[4]{x} \right)$$

Solution

(a) Use chain rule, then use quotient rule.

$$\frac{d}{dx} \left(\tan \left(\frac{\ln(x)}{2x-5} \right) \right) = \sec^2 \left(\frac{\ln(x)}{2x-5} \right) \cdot \frac{\frac{1}{x} \cdot (2x-5) - \ln(x) \cdot 2}{(2x-5)^2}$$

(b) Use product rule on the first term and chain rule on the second term.

$$\frac{d}{dx} (3x^7 \cos(x) - 8e^{3x}) = 21x^6 \cos(x) - 3x^7 \sin(x) - 24e^{3x}$$

(c) Use power rule on each term.

$$\frac{d}{dx} (10x^{12} - 3x^{-3} + x^{1/4}) = 120x^{11} + 9x^{-4} + \frac{1}{4}x^{-3/4}$$

12 p

312. Find the x -coordinate of each point on the graph of $y = 6x^3 - 9x^2 - 16x + 5$ at which the tangent line is perpendicular to the line $x + 20y = 10$.

Solution

The equation $x + 20y = 10$ can be written as $y = -\frac{1}{20}x + \frac{1}{2}$, whence the slope of the given line is $-\frac{1}{20}$. The desired tangent line is perpendicular to the given line, and thus has slope 20. So we must solve the equation $\frac{dy}{dx} = 20$, where $y = 6x^3 - 9x^2 - 16x + 5$.

$$\frac{dy}{dx} = 20 \implies 18x^2 - 18x - 16 = 20 \implies 18(x-2)(x+1) = 0$$

Thus the desired x -coordinates are $x = 2$ and $x = -1$.

12 p

313. Find all points on the graph of the following equation where the tangent line is vertical.

$$x^2 - 2xy + 10y^2 = 450$$

Solution

We first find $\frac{dy}{dx}$ using implicit differentiation.

$$2x - 2y - 2x \frac{dy}{dx} + 20y \frac{dy}{dx} = 0$$

Solving for $\frac{dy}{dx}$ algebraically gives

$$\frac{dy}{dx} = \frac{2y - 2x}{20y - 2x}$$

The slope of a vertical line is undefined (infinite), thus we seek points for which $\frac{dy}{dx}$ is undefined (infinite). Thus vertical tangent lines occur at points where $20y - 2x = 0$, or where $x = 10y$.

These points also lie on the curve itself. Substituting $x = 10y$ into the equation for the curve gives:

$$(10y)^2 - 2(10y)y + 10y^2 = 450 \implies 90y^2 = 450 \implies y = \pm\sqrt{5}$$

Hence the points where the curve has a vertical tangent are $(10\sqrt{5}, \sqrt{5})$ and $(-10\sqrt{5}, -\sqrt{5})$.

Alternatively... we can observe that a vertical tangent line occurs where $\frac{dx}{dy} = 0$. Then implicitly differentiate the equation of the curve *with respect to x* and then set $\frac{dx}{dy}$ to 0.

12 p 314. Suppose that an equation to the tangent line to $y = f(x)$ at $x = 9$ is $y = 3x - 20$. Let $g(x) = xf(x^2)$.

- Calculate $f(9)$ and $f'(9)$. Explain.
- Calculate $g'(x)$.
- Find the tangent line to $y = g(x)$ at $x = -3$.

Solution

- The tangent line to f at $x = 9$ is the line that passes through $(9, f(9))$ with slope $f'(9)$. The line $y = 3x - 20$ passes through $(9, 7)$ and has slope 3. Thus $f(9) = 7$ and $f'(9) = 3$.
- Use product rule, then chain rule.

$$g'(x) = 1 \cdot f(x^2) + x \cdot f'(x^2) \cdot 2x = f(x^2) + 2x^2 f'(x^2)$$

- We have the following (use the results of parts (a) and (b)):

$$g(-3) = (xf(x^2))|_{x=-3} = -3 \cdot f(9) = -3 \cdot 7 = -21$$

$$g'(-3) = (f(x^2) + 2x^2 f'(x^2))|_{x=-3} = f(9) + 18 \cdot f'(9) = 7 + 18 \cdot 3 = 61$$

Thus the tangent line to g at $x = -3$ has the equation:

$$y = -21 + 61(x + 3)$$

12 p 315. Let $f(x) = \frac{4}{x-6} + 3$. Use the limit definition of derivative to calculate $f'(8)$. *If you simply quote a rule, you will receive no credit. You must use the definition of derivative.*

Solution

Use the definition of derivative, find a common denominator, and then cancel common factors.

$$\begin{aligned} f'(8) &= \lim_{h \rightarrow 0} \left(\frac{f(8+h) - f(8)}{h} \right) = \lim_{h \rightarrow 0} \left(\frac{\frac{4}{8+h-6} + 3 - 5}{h} \right) = \lim_{h \rightarrow 0} \left(\frac{\frac{4}{2+h} - 2}{h} \right) \\ &= \lim_{h \rightarrow 0} \left(\frac{4 - 2(2+h)}{h(2+h)} \right) = \lim_{h \rightarrow 0} \left(\frac{-2h}{h(2+h)} \right) = \lim_{h \rightarrow 0} \left(\frac{-2}{2+h} \right) = \frac{-2}{2+0} = -1 \end{aligned}$$

12 p 316. A rocket is launched so that it rises vertically. A camera is positioned 5000 feet from the launch pad and turns so that it stays focused on the rocket. At the moment when the rocket is 12,000 feet above the launch pad, its velocity is 600 feet/sec. Let h be the height of the rocket above the launch pad and let θ be the viewing angle of the camera. See the figure below.

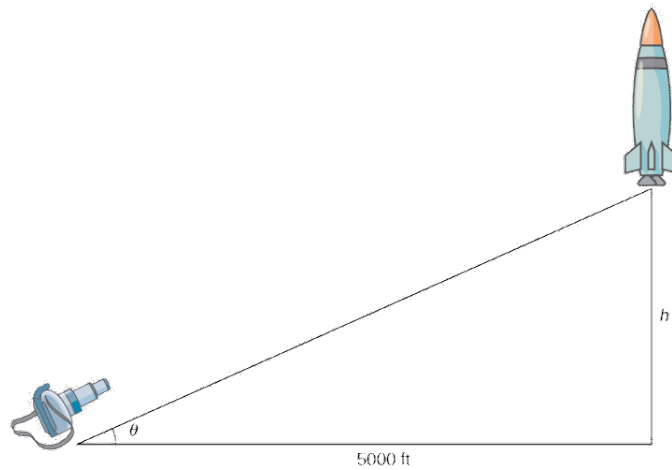

- (a) Determine the sign of $\frac{d}{dt}(\cos(\theta))$ at the moment described or determine that there is not enough information to do so.
- (b) Determine the sign of $\frac{d^2h}{dt^2}$ at the moment described or determine that there is not enough information to do so.
- (c) At the moment described, what is the rate at which the camera is turning? That is, what is the rate at which θ is changing over time? *You must include proper units as part of your answer.*

Solution

- (a) Note that $\cos(\theta) = \frac{5000}{L}$, where L is the distance from the camera to the rocket (the length of the hypotenuse of the right triangle). Since L is increasing as the rocket rises, the fraction $\frac{5000}{L}$ is decreasing. Thus the sign of $\frac{d}{dt}(\cos(\theta))$ is negative.
- (b) Note that $\frac{dh}{dt}$ is the velocity v of the rocket. Thus $\frac{d^2h}{dt^2} = \frac{dv}{dt}$. We are not given any information about $\frac{dv}{dt}$, and so the answer is “not enough information”. (For instance, if we were given that the rocket rises at a constant speed, we could conclude $\frac{dv}{dt} = 0$.)
- (c) We seek the rate at which the camera is turning, or $\frac{d\theta}{dt}$. Since we are given information about the variables θ and h only, our equation relating them is:

$$\tan(\theta) = \frac{h}{5000}$$

Differentiating this equation with respect to t gives

$$\sec^2(\theta) \frac{d\theta}{dt} = \frac{1}{5000} \frac{dh}{dt}$$

At the moment described, we have $h = 12000$ and $\frac{dh}{dt} = 600$. Substituting these values into our previous equations gives:

$$\tan(\theta) = \frac{12}{5} \quad \sec^2(\theta) \frac{d\theta}{dt} = \frac{3}{25}$$

At the moment described, the right triangle is a 5-12-13 right triangle. Thus $\sec(\theta) = \frac{13}{5}$ at the moment described. So our second equation gives:

$$\left(\frac{13}{5}\right)^2 \frac{d\theta}{dt} = \frac{3}{25} \implies \frac{d\theta}{dt} = \frac{3}{169}$$

The units are “radians per second”.

16 p

317. For each part, mark “T” if the statement is true or mark “F” if the statement is false. You do not have to explain your answers or show any work.

- (a) T F If f is continuous at $x = 3$, then f is differentiable at $x = 3$.
- (b) T F If f is differentiable at $x = 3$, then f is continuous at $x = 3$.
- (c) T F If $f'(x) = g'(x)$ for all x , then $f(x) = g(x)$ for all x .
- (d) T F The function $f(x) = |x|$ has two tangent lines at $x = 0$: the lines $y = x$ and $y = -x$.
- (e) T F If $f(x) = x^{1/3}$, then $f'(0)$ does not exist.
- (f) T F If $f(x) = x^{1/3}$, then there is no tangent line to f at $x = 0$.
- (g) T F $\frac{d}{dx}(e^{2x}) = 2xe^{2x-1}$
- (h) T F A certain cylindrical tank has a radius of 5 ft. If the height of the water in the tank increases at a constant rate, then the volume of the water in the tank also increases at a constant rate.

Solution

- (a) **False.** Let $f(x) = |x - 3|$. Then f is continuous at $x = 3$ but not differentiable at $x = 3$.
- (b) **True.** This is the exact statement of Theorem 3.1 on page 146 of the textbook (Briggs et al., *Pearson 2018*).
- (c) **False.** Let $f(x) = 0$ and let $g(x) = 1$. Then $f'(x) = g'(x)$ but f and g are not the same function.
- (d) **False** Since $f(x) = |x|$ is not differentiable at $x = 0$, the tangent line to f at $x = 0$ doesn't exist.
- (e) **True.** By definition of the derivative, we have:

$$f'(0) = \lim_{h \rightarrow 0} \left(\frac{f(h) - f(0)}{h} \right) = \lim_{h \rightarrow 0} \left(\frac{h^{1/3}}{h} \right) = \lim_{h \rightarrow 0} \left(\frac{1}{h^{2/3}} \right) = +\infty$$

Since this limit is not a finite number, $f'(0)$ does not exist.

(Alternatively, we can observe that the graph of $y = f(x)$ has a vertical tangent line at $x = 0$. Thus $f'(0)$ does not exist.)

- (f) **False.** From the solution for part (e), we see that $f'(0)$ does not exist but the corresponding limit is $+\infty$. Thus there is a vertical tangent line to f at $x = 0$.

(Alternatively, we can observe that the graph of $y = f(x)$ has a vertical tangent line at $x = 0$.)

- (g) **False.** Chain rule gives $\frac{d}{dx}(e^{2x}) = 2e^{2x}$.

- (h) **True.** Note that $V = \frac{25\pi}{3}h$, where V and h are the volume and height of the water in the tank, respectively. Taking derivatives gives $\frac{dV}{dt} = \frac{25\pi}{3} \frac{dh}{dt}$. Thus if $\frac{dh}{dt}$ is constant, so is $\frac{dV}{dt}$.

Midterm Exam #3

15 p

318. Let $f(x) = Ax^B \ln(x)$, where A and B are unspecified constants. Suppose that $(e^5, 10)$ is a point of local extremum for $f(x)$.

- (a) Calculate the values of A and B .
- (b) Determine whether $(e^5, 10)$ is a point of local minimum or a point of local maximum for $f(x)$. Explain your answer.

Solution

- (a) Since the point $(e^5, 10)$ lies on the graph of f , we must have $f(e^5) = 10$. Since the point $(e^5, 10)$ is a point of local extremum for f , we must have that $x = e^5$ is a critical point of f , whence $f'(e^5) = 0$. So A and B must simultaneously satisfy the equations:

$$f(e^5) = 10 \quad f'(e^5) = 0$$

The derivative of f is:

$$f'(x) = ABx^{B-1} \ln(x) + Ax^B \cdot \frac{1}{x} = ABx^{B-1} \ln(x) + Ax^{B-1} = Ax^{B-1} (B \ln(x) + 1)$$

So our system of equations is:

$$5Ae^{5B} = 10 \quad Ae^{5(B-1)} (5B + 1) = 0$$

The second equation above gives either $A = 0$ (which can't satisfy the first equation, and thus is not a valid solution) or $5B + 1 = 0$. Thus $B = -\frac{1}{5}$. Substituting $B = -\frac{1}{5}$ and solving for A gives:

$$5Ae^{5B} = 10 \implies 5Ae^{-1} = 10 \implies A = 2e$$

- (b) From part (a), we now have f and f' :

$$f(x) = 2ex^{-1/5} \ln(x) \quad f'(x) = 2ex^{-6/5} \left(-\frac{1}{5} \ln(x) + 1 \right)$$

To determine the nature of the local extremum, we use the first derivative test. The only critical point of f is $x = e^5$, so our sign chart for $f'(x)$ has two intervals to test: $(0, e^5)$, for which we can choose e^4 as a test point; and (e^5, ∞) , for which we can choose e^6 as a test point. We have the following:

$$f'(e^4) = 2e \cdot e^{-24/5} \left(-\frac{1}{5} \cdot 4 + 1 \right) = \oplus \cdot \left(\frac{1}{5} \right) = \oplus$$

$$f'(e^6) = 2e \cdot e^{-26/5} \left(-\frac{1}{5} \cdot 6 + 1 \right) = \oplus \cdot \left(-\frac{1}{5} \right) = \ominus$$

Thus we see that f is increasing on the interval $(0, e^5]$ and decreasing on the interval $[e^5, \infty)$. Thus $x = e^5$ gives rise to a local maximum of f .

20 p

319. For each part, find the absolute extreme values of the given function on the given interval. If a particular extreme value does not exist, write "DNE" as your answer, and explain why that extreme value does not exist.

(a) $f(x) = \frac{e}{x} + \ln(x)$ on $[1, e^3]$

(b) $g(x) = 12x - x^3$ on $[0, \infty)$

Solution(a) We first find the critical points by solving $f'(x) = 0$.

$$f'(x) = -\frac{e}{x^2} + \frac{1}{x} = 0 \implies -e + x = 0 \implies x = e$$

Now we compare the endpoint values and critical value.

$$f(1) = \frac{e}{1} + 0 = e \quad f(e) = \frac{e}{e} + 1 = 2 \quad f(e^3) = \frac{e}{e^3} + 3 = \frac{1}{e^2} + 3$$

(Recall that $2 < e < 3$.) Thus the absolute minimum of f is 2 and the absolute maximum of f is $\frac{1}{e^2} + 3$.(b) We first find the critical points by solving $f'(x) = 0$.

$$f'(x) = 12 - 3x^2 = 0 \implies x^2 = 4 \implies x = 2$$

(Note that we reject the solution $x = -2$ since it's not in the given interval.) We can't use the extreme value theorem here because the given interval is not bounded.Observe that $f''(x) = -6x$, whence $f''(2) < 0$. So $x = 2$ gives a local maximum of f on $[0, \infty)$. Since $x = 2$ is the only critical point on this interval, $x = 2$ gives an absolute maximum, and so the absolute maximum of f is $f(2) = 24 - 8 = 16$. However, since $\lim_{x \rightarrow \infty} f(x) = -\infty$, there is no absolute minimum.**18 p**

320. A rancher plans to make four identical and adjacent rectangular pens against a barn, each with an area of 100 m^2 (see the figure below). What are the dimensions of each pen that minimize the amount of fence that must be used? **Note:** No fencing is needed on the side of the pen that borders the barn (the north side of the pen).

As you work, fill in the answer boxes below. You must use calculus-based methods in your work. You must also justify that your answer really does give the maximum.

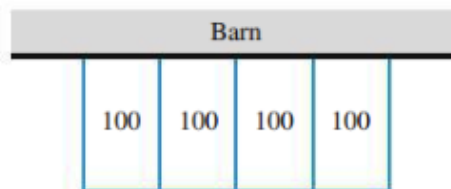

constraint equation(s):	
objective function in one variable only:	
interval of interest:	
dimensions of one pen:	$\frac{\text{horizontal dimension}}{\text{horizontal dimension}} \times \frac{\text{vertical dimension}}{\text{vertical dimension}}$

Solution

Let x and y be the horizontal and vertical dimensions of one individual pen, respectively. We seek to minimize the total length of fencing, thus our objective function is

$$F(x, y) = 4x + 5y$$

Each individual pen must have area 100, and so our constraint equation is $xy = 100$. Solving for y gives $y = \frac{100}{x}$. Thus the objective function can be written in terms of x only as

$$f(x) = 4x + \frac{500}{x}$$

We seek the value of x that gives the absolute minimum of f on the interval $(0, \infty)$. We now find the critical points.

$$f'(x) = 4 - \frac{500}{x^2} = 0 \implies x^2 = 125 \implies x = \sqrt{125}$$

(We reject the solution $x = -\sqrt{125}$ since the length can't be negative.) Since the interval of interest is not closed, we can't use the extreme value theorem to verify the nature of the critical point $x = \sqrt{125}$.

Observe that $f''(x) = \frac{1000}{x^3}$, whence $f''(\sqrt{125}) > 0$, and so $x = \sqrt{125}$ gives a local minimum. Since $x = \sqrt{125}$ is the only critical point in the interval, it must also give an absolute minimum. Thus the desired dimensions of an individual pen are $x = \sqrt{125}$ and $y = \frac{100}{x} = \frac{4}{5}\sqrt{125}$.

Note: In reality, the interval of interest is $(0, \frac{L}{4}]$ where L is the length of the barn, but since we are not given L , we can just assume the barn is sufficiently large. Mathematically, we can assume L is large enough so the critical point of f lies in the interval $(0, \frac{L}{4}]$.

18 p 321. Consider the function f and its derivatives below.

$$f(x) = \frac{x^2}{x-7} \quad f'(x) = \frac{x(x-14)}{(x-7)^2} \quad f''(x) = \frac{98}{(x-7)^3}$$

Fill in the table below with information about the graph of $y = f(x)$. For each part, write "NONE" as your answer if appropriate. Where applicable, give a comma-separated list of intervals that are as inclusive as possible.

You do not have to show work, and each table item will be graded with no partial credit.

Solution

equation(s) of vertical asymptote(s) of f	$x = 7$
equation(s) of horizontal asymptote(s) of f	NONE
where f is decreasing	$[0, 7), (7, 14]$
where f is increasing	$(-\infty, 0], [14, \infty)$
x -coordinate(s) of local minima of f	$x = 14$
x -coordinate(s) of local maxima of f	$x = 0$
where f is concave down	$(-\infty, 7)$
where f is concave up	$(7, \infty)$
x -coordinate(s) of inflection point(s) of f	NONE

The derivatives of f are

$$f(x) = \frac{x^2}{x-7} \quad f'(x) = \frac{x(x-14)}{(x-7)^2} \quad f''(x) = \frac{98}{(x-7)^3}$$

(i) *Vertical asymptotes and horizontal asymptotes.*

Observe that f is continuous on its domain, but is undefined for $x = 7$. Hence our candidate vertical asymptote is the line $x = 7$. Indeed, direct substitution of $x = 7$ into $f(x)$ gives the expression $\frac{49}{0}$, which indicates that both one-sided limits are infinite. Hence the line $x = 7$ is a true vertical asymptote.

As for the horizontal asymptotes we have the following.

$$\lim_{x \pm \infty} \left(\frac{x^2}{x-7} \right) = \lim_{x \pm \infty} \left(\frac{x}{1 - \frac{7}{x}} \right) = \frac{\pm \infty}{1-0} = \pm \infty$$

Since neither limit (as either $x \rightarrow -\infty$ or $x \rightarrow \infty$) is finite, there are no horizontal asymptotes.

(ii) *Intervals of increase and local extrema.*

We calculate a sign chart for the first derivative. The cut points are the solutions to $f'(x) = 0$ ($x = 0$ and $x = 14$) and the vertical asymptotes ($x = 7$).

interval	test point	sign of f'	shape of f
$(-\infty, 0)$	$f'(-1)$	$\frac{\ominus \ominus}{\oplus} = \oplus$	increasing
$(0, 7)$	$f'(1)$	$\frac{\oplus \ominus}{\oplus} = \ominus$	decreasing
$(7, 14)$	$f'(8)$	$\frac{\oplus \ominus}{\oplus} = \ominus$	decreasing
$(14, \infty)$	$f'(15)$	$\frac{\oplus \oplus}{\oplus} = \oplus$	increasing

Hence we deduce the following about f :

$$\begin{aligned} f \text{ is decreasing on:} & \quad [0, 7), (7, 14] \\ f \text{ is increasing on:} & \quad (-\infty, 0], [14, \infty) \\ f \text{ has a local min at:} & \quad x = 14 \\ f \text{ has a local max at:} & \quad x = 0 \end{aligned}$$

(iii) *Intervals of concavity and inflection points.*

We calculate a sign chart for the second derivative: The cut points are the solutions to $f''(x) = 0$ (none) and the vertical asymptotes ($x = 7$).

interval	test point	sign of f''	shape of f
$(-\infty, 7)$	$f''(0)$	$\ominus = \ominus$	concave down
$(7, \infty)$	$f''(8)$	$\oplus = \oplus$	concave up

Hence we deduce the following about f :

$$\begin{aligned} f \text{ is concave down on:} & \quad (-\infty, 7) \\ f \text{ is concave up on:} & \quad (7, \infty) \\ f \text{ has an infl. point at:} & \quad \text{none} \end{aligned}$$

(iv) *Sketch of graph.*

Not required.

322. Let $f(x) = x^2 e^x$.

7 p

(a) Calculate the vertical and horizontal asymptotes of f .

(b) Calculate the critical points of f . Then use the Second Derivative Test to classify each critical point of f as a local minimum or a local maximum. Show your work and label your answers clearly. **Hint:** The second derivative of f is $f''(x) = (x^2 + 4x + 2)e^x$.

10 p

Solution

(a) Since f is a product of functions that are continuous for all x , f is also continuous for all x , and thus f has no vertical asymptotes. For horizontal asymptotes, we have the following (use l'Hospital's rule on the limit at negative infinity):

$$\begin{aligned} \lim_{x \rightarrow \infty} (x^2 e^x) &= (+\infty) \cdot (+\infty) = +\infty \\ \lim_{x \rightarrow -\infty} (x^2 e^x) &= \lim_{x \rightarrow -\infty} \left(\frac{x^2}{e^{-x}} \right) \stackrel{H}{=} \lim_{x \rightarrow -\infty} \left(\frac{2x}{-e^{-x}} \right) \stackrel{H}{=} \lim_{x \rightarrow -\infty} \left(\frac{2}{e^{-x}} \right) = \frac{2}{\infty} = 0 \end{aligned}$$

Thus the only horizontal asymptote of f is $y = 0$.

(b) We first compute $f'(x)$.

$$f'(x) = 2xe^x + x^2 e^x = xe^x(2 + x)$$

Thus the critical points (solutions to $f'(x) = 0$) are $x = 0$ and $x = -2$. Now we use the

Second Derivative Test.

$$f''(0) = (x^2 + 4x + 2)e^x \Big|_{x=0} = 2$$

$$f''(-2) = (x^2 + 4x + 2)e^x \Big|_{x=-2} = -2e^{-2}$$

Since $f''(0) > 0$, $x = 0$ gives a local minimum of f . Since $f''(-2) < 0$, $x = -2$ gives a local maximum of f .

12 p

323. Let $f(x) = \frac{x \sin(Ax)}{\sin^2(2x)}$, where A is a constant. Suppose $\lim_{x \rightarrow 0} f(x) = -6$. Calculate A .

Solution

We first compute the given limit in terms of A . Substitution of $x = 0$ gives " $\frac{0}{0}$ ", so we use l'Hospital's rule (twice), then use direct substitution.

$$\begin{aligned} \lim_{x \rightarrow 0} \left(\frac{x \sin(Ax)}{\sin^2(2x)} \right) &\stackrel{H}{=} \lim_{x \rightarrow 0} \left(\frac{\sin(Ax) + Ax \cos(Ax)}{4 \sin(2x) \cos(2x)} \right) \\ &\stackrel{H}{=} \lim_{x \rightarrow 0} \left(\frac{A \cos(Ax) + A \cos(Ax) - A^2 x \sin(Ax)}{8 \cos(2x) \cos(2x) - 8 \sin(2x) \sin(2x)} \right) = \frac{A + A - 0}{2A(A - 0)} = \frac{2A}{8 - 0} = \frac{A}{4} \end{aligned}$$

We are given that the limit is -6 , whence $\frac{A}{4} = -6$, and so $A = -24$.

Alternatively... we can use special trigonometric limits instead of l'Hospital's rule.

$$\lim_{x \rightarrow 0} \left(\frac{x \sin(Ax)}{\sin^2(2x)} \right) = \lim_{x \rightarrow 0} \left(\frac{2x}{\sin(2x)} \cdot \frac{2x}{\sin(2x)} \cdot \frac{\sin(Ax)}{Ax} \cdot \frac{x \cdot Ax}{2x \cdot 2x} \right) = 1 \cdot 1 \cdot 1 \cdot \frac{A}{4} = \frac{A}{4}$$

1.13 Fall 2022

Midterm Exam #1

15 p

324. On the axes provided, sketch the graph of a function $f(x)$ that satisfies all of the following properties.
Note: Make sure to read these properties carefully!

- the domain of $f(x)$ is $[-10, 7) \cup (7, 10]$
- $\lim_{x \rightarrow -8} f(x)$ exists but f is discontinuous at $x = -8$
- $\lim_{x \rightarrow -5^+} f(x) = f(-5)$ but $\lim_{x \rightarrow -5} f(x)$ does not exist
- $\lim_{x \rightarrow 2^-} f(x) = 4$ and f is continuous at $x = 2$
- the line $x = 5$ is a vertical asymptote for f (**Note:** $x = 5$ is in the domain of f .)
- $\lim_{x \rightarrow 7} f(x) = +\infty$ (**Note:** $x = 7$ is not in the domain of f .)

Solution

There are many such solutions. Here is one.

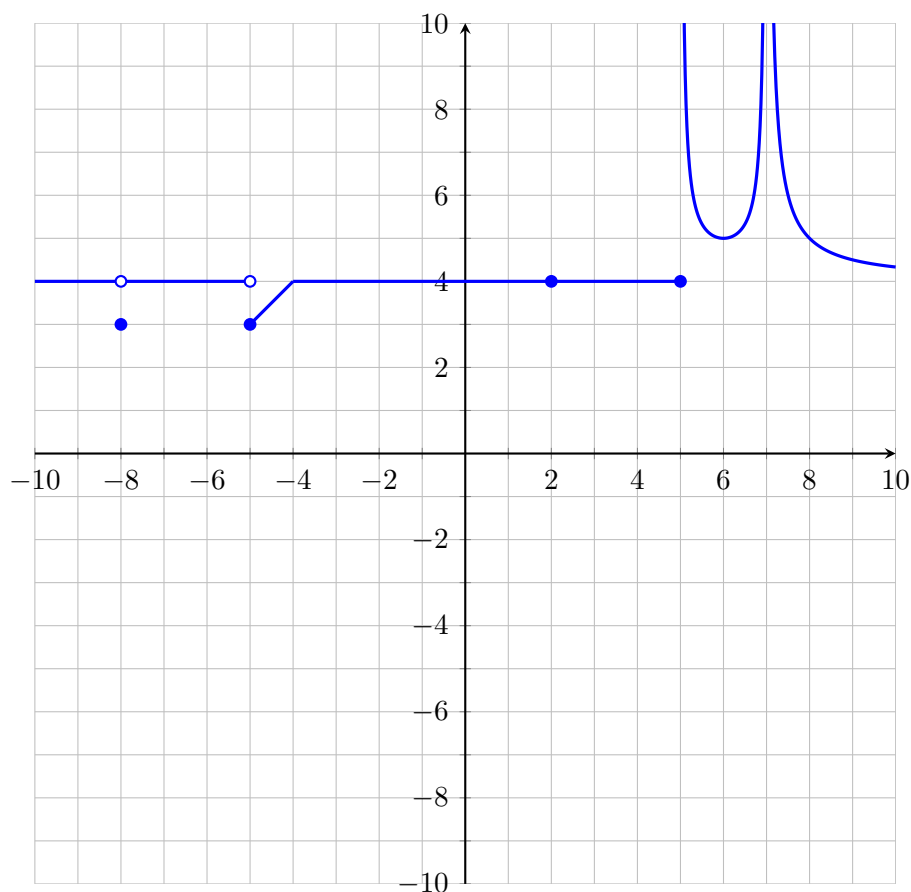

30 p

325. For each part, calculate the limit or show that it does not exist. *If the limit is $+\infty$ or $-\infty$, write that as your answer, instead of "does not exist".*

$$(a) \lim_{x \rightarrow 8} \left(\frac{(x-2)^2 - 36}{x-8} \right) \quad (b) \lim_{x \rightarrow 5} \left(\frac{40 - 8x}{\sqrt{19 - 3x} - 2} \right) \quad (c) \lim_{x \rightarrow 2^-} \left(\frac{4 + x}{x^2 + x - 6} \right)$$

Solution

(a) Expand the numerator. Then cancel common factors.

$$\lim_{x \rightarrow 8} \left(\frac{(x-2)^2 - 36}{x-8} \right) = \lim_{x \rightarrow 8} \left(\frac{x^2 - 4x - 32}{x-8} \right) = \lim_{x \rightarrow 8} \left(\frac{(x-8)(x+4)}{x-8} \right) = \lim_{x \rightarrow 8} (x+4) = 12$$

(b) Rationalize the denominator. Then cancel common factors.

$$\begin{aligned} \lim_{x \rightarrow 5} \left(\frac{40 - 8x}{\sqrt{19 - 3x} - 2} \right) &= \lim_{x \rightarrow 5} \left(\frac{40 - 8x}{\sqrt{19 - 3x} - 2} \cdot \frac{\sqrt{19 - 3x} + 2}{\sqrt{19 - 3x} + 2} \right) \\ &= \lim_{x \rightarrow 5} \left(\frac{8(5-x)(\sqrt{19-3x}+2)}{19-3x-4} \right) = \lim_{x \rightarrow 5} \left(\frac{8(5-x)(\sqrt{19-3x}+2)}{3(5-x)} \right) \\ &= \lim_{x \rightarrow 5} \left(\frac{8}{3} (\sqrt{19-3x}+2) \right) = \frac{8}{3} (\sqrt{4}+2) = \frac{32}{3} \end{aligned}$$

(c) Direct substitution of $x = 2$ gives the undefined expression “ $\frac{6}{0}$ ” (i.e., a nonzero number divided by 0). Hence the one-sided limit is infinite. Observe that the denominator is $x^2 + x - 6 = (x+3)(x-2)$. As $x \rightarrow 2^-$, the factor $(x+3)$ is positive and the factor $(x-2)$ is negative. Thus the entire fraction has the following sign as $x \rightarrow 2^-$: $\frac{6}{\oplus \ominus} = \ominus$. Thus the limit is equal to $-\infty$.

326. Consider the function below, where a and b are unspecified constants.

$$f(x) = \begin{cases} \frac{\sin(4x) \sin(6x)}{x^2} & x < 0 \\ ax + b & 0 \leq x \leq 1 \\ \frac{5x+2}{x-1} - \frac{2x+5}{x^2-x} & x > 1 \end{cases}$$

10 p (a) Calculate $\lim_{x \rightarrow 0^-} f(x)$.

10 p (b) Calculate $\lim_{x \rightarrow 1^+} f(x)$.

5 p (c) Find the values of a and b for which f is continuous for all x , or determine that no such values exist. *In your work, you must use limit-based methods to solve this problem. Solutions that have work that is not based on limits will not receive full credit.*

Solution

(a) Rearrange the terms and use the special trigonometric limit $\lim_{\theta \rightarrow 0} \left(\frac{\sin(a\theta)}{a\theta} \right) = 1$.

$$\lim_{x \rightarrow 0^-} f(x) = \lim_{x \rightarrow 0^-} \left(\frac{\sin(4x) \sin(6x)}{x^2} \right) = \lim_{x \rightarrow 0^-} \left(\frac{\sin(4x)}{4x} \cdot \frac{\sin(6x)}{6x} \cdot 4 \cdot 6 \right) = 1 \cdot 1 \cdot 4 \cdot 6 = 24$$

(b) Find a common denominator. Then cancel common factors.

$$\begin{aligned}\lim_{x \rightarrow 1^+} f(x) &= \lim_{x \rightarrow 1^+} \left(\frac{5x+2}{x-1} - \frac{2x+5}{x^2-x} \right) = \lim_{x \rightarrow 1^+} \left(\frac{5x^2+2x}{x^2-x} - \frac{2x+5}{x^2-x} \right) \\ &= \lim_{x \rightarrow 1^+} \left(\frac{5x^2-5}{x^2-x} \right) = \lim_{x \rightarrow 1^+} \left(\frac{5(x-1)(x+1)}{x(x-1)} \right) = \lim_{x \rightarrow 1^+} \left(\frac{5(x+1)}{x} \right) = \frac{5(1+1)}{1} = 10\end{aligned}$$

(c) If f is to be continuous at $x = 0$, the left-limit, right-limit, and function value of f at $x = 0$ must be equal.

$$\begin{aligned}\lim_{x \rightarrow 0^-} f(x) &= 24 \\ \lim_{x \rightarrow 0^+} f(x) &= \lim_{x \rightarrow 0^+} (ax + b) = b \\ f(0) &= (ax + b)|_{x=0} = b\end{aligned}$$

Thus we must have $b = 24$. If f is to be continuous at $x = 1$, the left-limit, right-limit, and function value of f at $x = 1$ must be equal.

$$\begin{aligned}\lim_{x \rightarrow 1^-} f(x) &= \lim_{x \rightarrow 1^-} (ax + b) = a + b \\ \lim_{x \rightarrow 1^+} f(x) &= 10 \\ f(0) &= (ax + b)|_{x=1} = a + b\end{aligned}$$

Thus we must have $a + b = 10$. Given $b = 24$, we find that $a = -14$.

15 p **327.** Find all vertical asymptotes of the function $f(x) = \frac{x^3 - 36x}{x^3 - 12x^2 + 36x}$.

In your work, you must use limit-based methods to solve this problem. Solutions that have work that is not based on limits will not receive full credit.

Solution

Since $f(x)$ is a rational function, VA's can occur only where the denominator of $f(x)$ vanishes.

$$x^3 - 12x^2 + 36x = 0 \implies x(x^2 - 12x + 36) = x(x - 6)^2 = 0$$

Thus $f(x)$ can have a VA at $x = 0$ or $x = 6$ only.

For $x = 0$, we note the following:

$$\lim_{x \rightarrow 0} f(x) = \lim_{x \rightarrow 0} \left(\frac{x^3 - 36x}{x^3 - 12x^2 + 36x} \right) = \lim_{x \rightarrow 0} \left(\frac{x(x-6)(x+6)}{x(x-6)^2} \right) = \lim_{x \rightarrow 0} \left(\frac{x+6}{x-6} \right) = \frac{0+6}{0-6} = -1$$

Since this limit is finite, we find that the line $x = 0$ is not a VA for $f(x)$.

For $x = 6$, we note the following:

$$\lim_{x \rightarrow 6} f(x) = \lim_{x \rightarrow 6} \left(\frac{x+6}{x-6} \right)$$

At this point, direct substitution of $x = 6$ gives the expression " $\frac{12}{0}$ " (i.e., a nonzero number divided by 0). This immediately implies that each corresponding one-sided limit is infinite. Thus the line $x = 6$ is a VA for $f(x)$.

15 p **328.** Find all horizontal asymptotes of the function $h(x) = \frac{6x + 5}{\sqrt{4x^2 - 9}}$.

In your work, you must use limit-based methods to solve this problem. Solutions that have work that is not based on limits will not receive full credit.

Solution

We must compute the limits at infinity. First we complete some algebraic manipulations by first factoring out the largest powers of x in numerator and denominator of $h(x)$, separately. Note that $\sqrt{x^2} = |x|$.

$$\frac{6x + 5}{\sqrt{4x^2 + 9}} = \frac{x(6 + \frac{5}{x})}{\sqrt{x^2(4 + \frac{9}{x^2})}} = \frac{x}{\sqrt{x^2}} \cdot \frac{6 + \frac{5}{x}}{\sqrt{4 + \frac{9}{x^2}}} = \frac{x}{|x|} \cdot \frac{6 + \frac{5}{x}}{\sqrt{4 + \frac{9}{x^2}}}$$

Now we compute the necessary limits. Note that as $x \rightarrow \infty$, we have $|x| = x$, and so $x/|x| = x/x = 1$.

$$\lim_{x \rightarrow +\infty} f(x) = \lim_{x \rightarrow +\infty} \left(\frac{x}{|x|} \cdot \frac{6 + \frac{5}{x}}{\sqrt{4 + \frac{9}{x^2}}} \right) = \lim_{x \rightarrow +\infty} \left(1 \cdot \frac{6 + \frac{5}{x}}{\sqrt{4 + \frac{9}{x^2}}} \right) = 1 \cdot \frac{6 + 0}{\sqrt{4 + 0}} = \frac{6}{2} = 3$$

Now note that as $x \rightarrow -\infty$, we have $|x| = -x$, and so $x/|x| = x/(-x) = -1$.

$$\lim_{x \rightarrow -\infty} f(x) = \lim_{x \rightarrow -\infty} \left(\frac{x}{|x|} \cdot \frac{6 + \frac{5}{x}}{\sqrt{4 + \frac{9}{x^2}}} \right) = \lim_{x \rightarrow -\infty} \left(-1 \cdot \frac{6 + \frac{5}{x}}{\sqrt{4 + \frac{9}{x^2}}} \right) = -1 \cdot \frac{6 + 0}{\sqrt{4 + 0}} = \frac{6}{2} = -3$$

Thus the HA's of $h(x)$ are the lines $y = 3$ and $y = -3$.

Midterm Exam #2

329. For each part, calculate the indicated derivative. Do not simplify your answer.

6 p

$$(a) \frac{d}{dx} \left(7x^{10} + \sqrt[3]{x} - \frac{8}{x^{20}} + \sec(8x) \right)$$

6 p

$$(b) \frac{d}{dx} \left(\frac{\ln(x^3 + 30)}{8x} \right)$$

6 p

$$(c) \frac{d}{dx} (\sin(xe^{-5x}))$$

Solution

(a) Use power rule on the first three terms and chain rule on the last term.

$$\frac{d}{dx} \left(7x^{10} + x^{1/3} - 8x^{-20} + \sec(8x) \right) = 70x^9 + \frac{1}{3}x^{-2/3} + 160x^{-21} + 8\sec(8x)\tan(8x)$$

(b) Use quotient rule, then chain rule.

$$\frac{d}{dx} \left(\frac{\ln(x^3 + 30)}{8x} \right) = \frac{\frac{3x^2}{x^3+30} \cdot 8x - 8\ln(x^3 + 30)}{(8x)^2}$$

(c) Use chain rule, then product rule and chain rule.

$$\frac{d}{dx} (\sin(xe^{-5x})) = \cos(xe^{-5x}) \cdot (e^{-5x} - 5xe^{-5x})$$

14 p

330. A solid 14-foot tall garage door opens via a pulley mechanism. As the pulley opens the garage door, the top of the garage door (point P in the figure) moves to the right at 5 ft/s. At the same time, the bottom of the garage door (point Q in the figure) moves straight up.

As shown in the figure, the point R is the fixed point at the top of the garage door frame, x represents the distance between P and R , and y represents the distance between Q and R .

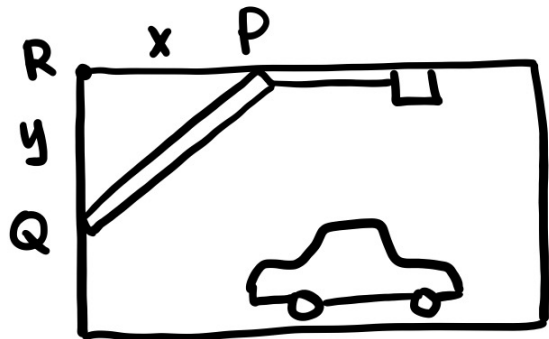

(a) What is the sign of $\frac{dx}{dt}$?

(b) What is the sign of $\frac{dy}{dt}$?

(c) What is the rate of change of the distance between the points Q and R when the distance between them is 9 feet? You must include correct units in your answer. You may leave unsimplified radicals in your answer.

Solution

(a) Since x is increasing, $\frac{dx}{dt}$ is positive.

(b) Since y is decreasing, $\frac{dy}{dt}$ is negative.

- (c) We have $x^2 + y^2 = 14^2$, and differentiating with respect to time gives $2x \frac{dx}{dt} + 2y \frac{dy}{dt} = 0$. At the described time we have $y = 6$ and $\frac{dx}{dt} = 5$. So substituting these values gives:

$$x^2 + 6^2 = 14^2 \quad 10x + 12 \frac{dy}{dt} = 0$$

The first equation gives $x = \sqrt{14^2 - 6^2} = \sqrt{(14 - 6)(14 + 6)} = \sqrt{8 \cdot 20} = \sqrt{160}$, whence we obtain

$$\frac{dy}{dt} = -\frac{10x}{12} = -\frac{5\sqrt{160}}{6}$$

The units of $\frac{dy}{dt}$ are ft/sec.

10 p

- 331.** For each part, use the graph of $y = f(x)$ to determine whether the value exists. If the value exists, state its sign (negative, positive, or zero).

- (a) $f'(-3)$
 (b) $f'(-2)$
 (c) $f'(-1)$
 (d) $f'(1)$
 (e) $f'(3)$

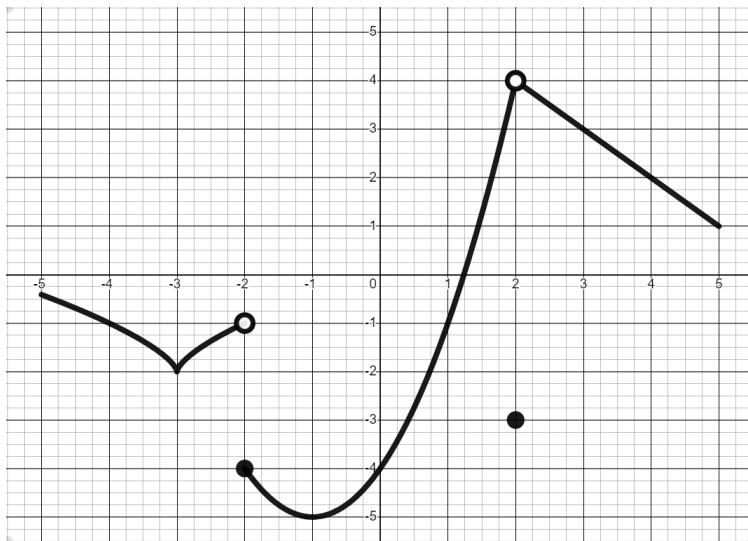

Solution

- (a) does not exist
 (b) does not exist
 (c) zero
 (d) positive
 (e) negative

14 p

- 332.** Consider the following curve.

$$\cos(5x + y - 5) = 8xe^y + y - 7$$

- (a) Calculate $\frac{dy}{dx}$ for a general point on the curve.
 (b) Find an equation of the line tangent to the curve at the point $(1, 0)$.

Solution

- (a) Differentiate both sides of the equation with respect to x , using chain rule on the left side and product rule on the right side.

$$-\sin(5x + y - 5) \cdot \left(5 + \frac{dy}{dx}\right) = 8e^y + 8xe^y \frac{dy}{dx} + \frac{dy}{dx}$$

Now algebraically solve for $\frac{dy}{dx}$. First expand the left side, then collect terms multiplying $\frac{dy}{dx}$ on one side.

$$\begin{aligned} -5\sin(5x + y - 5) - \sin(5x + y - 5)\frac{dy}{dx} &= 8e^y + 8xe^y\frac{dy}{dx} + \frac{dy}{dx} \\ (-\sin(5x + y - 5) - 8xe^y - 1)\frac{dy}{dx} &= 5\sin(5x + y - 5) + 8e^y \\ \frac{dy}{dx} &= \frac{5\sin(5x + y - 5) + 8e^y}{-\sin(5x + y - 5) - 8xe^y - 1} \end{aligned}$$

- (b) We substitute $x = 1$ and $y = 0$ into our formula for $\frac{dy}{dx}$.

$$\left.\frac{dy}{dx}\right|_{(x,y)=(1,0)} = \frac{5\sin(0) + 8e^0}{-\sin(0) - 8e^0 - 1} = -\frac{8}{9}$$

This is the slope of the desired tangent line. Hence the desired tangent line is

$$y = -\frac{8}{9}(x - 1)$$

15 p

- 333.** Find the coordinates of all points on the graph of $f(x) = x\sqrt{14 - x^2}$ where the tangent line is horizontal. You must give both the x - and y -coordinate of each such point.

Solution

We first find $f'(x)$ using product rule, then chain rule.

$$f'(x) = 1 \cdot (14 - x^2)^{1/2} + x \cdot \frac{1}{2}(14 - x^2)^{-1/2} \cdot (-2x) = \sqrt{14 - x^2} - \frac{x^2}{\sqrt{14 - x^2}}$$

The tangent line to the graph of $f(x)$ is horizontal at points where $f'(x) = 0$. To solve $f'(x) = 0$, multiply both sides by $\sqrt{14 - x^2}$, then solve for x .

$$\begin{aligned} \sqrt{14 - x^2} \cdot \left(\sqrt{14 - x^2} - \frac{x^2}{\sqrt{14 - x^2}}\right) &= 0 \\ 14 - x^2 - x^2 &= 0 \implies 14 - 2x^2 = 0 \implies x^2 = 7 \implies x = -\sqrt{7} \text{ or } x = \sqrt{7} \end{aligned}$$

Hence the graph has horizontal tangent lines at $x = -\sqrt{7}$ and $x = \sqrt{7}$.

14 p

- 334.** Let $f(x) = \frac{8x}{x + 5}$.

- (a) Calculate $f'(x)$ by any method.
 (b) Use the limit definition of derivative to calculate $f'(3)$. **Hint:** Use your answer from part (a) to check your final answer.

Solution

(a) Use quotient rule.

$$f'(x) = \frac{8(x+5) - 8x \cdot 1}{(x+5)^2} = \frac{40}{(x+5)^2}$$

(b) Observe that $f(3) = 3$, whence by the limit definition of derivative we have:

$$\begin{aligned} f'(3) &= \lim_{x \rightarrow 3} \left(\frac{f(x) - f(3)}{x - 3} \right) = \lim_{x \rightarrow 3} \left(\frac{\frac{8x}{x+5} - 3}{x - 3} \right) = \lim_{x \rightarrow 3} \left(\frac{8x - 3(x+5)}{(x-3)(x+5)} \right) \\ &= \lim_{x \rightarrow 3} \left(\frac{5(x-3)}{(x-3)(x+5)} \right) = \lim_{x \rightarrow 3} \left(\frac{5}{x+5} \right) = \frac{5}{3+5} = \frac{5}{8} \end{aligned}$$

15 p

335. The graph of $y = f(x)$ is given below.

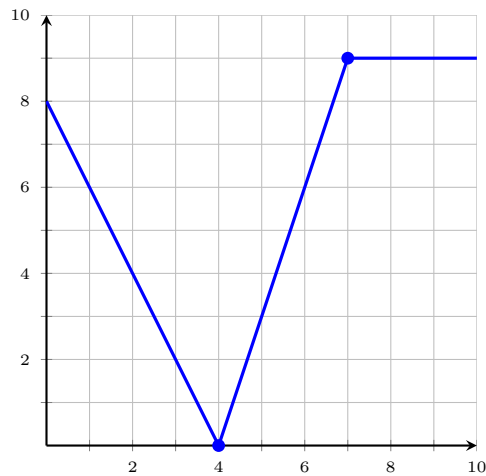

(a) Calculate $f'(6)$. Briefly explain how you found your answer.

(b) Let $g(x) = 9xf(2x)$. Find an equation of the line tangent to the graph of $y = g(x)$ at $x = 3$.

Solution

(a) The value $f'(6)$ is the slope of the tangent line to $y = f(x)$ at $x = 6$. The graph of $y = f(x)$ is a line with slope 3 on the interval $[4, 7]$. Thus $f'(6) = 3$.

(b) We find $g'(x)$ with product rule and chain rule.

$$g'(x) = 9f(2x) + 9xf'(2x) \cdot 2 = 9f(2x) + 18xf'(2x)$$

Now observe the following:

$$\begin{aligned} g(3) &= 9 \cdot 3 \cdot f(6) = 9 \cdot 3 \cdot 6 = 162 \\ g'(3) &= 9 \cdot f(6) + 18 \cdot 3 \cdot f'(6) = 9 \cdot 6 + 18 \cdot 3 \cdot 3 = 216 \end{aligned}$$

Thus the desired tangent line is $y = 162 + 216(x - 3)$.

2 Practice Worksheets

The exercises in these worksheets are marked as belonging to one of four difficulty categories.

C: CORE

An exercise categorized as “Core” (or “C”) is considered fundamental part of the course. Students must be able to solve C-level exercises to succeed in calculus. If a student uses calculus in other courses, these are the exercises they will almost certainly encounter and be expected to solve. These are generally the easiest exercises in the course, but they are not all necessarily easy.

B: BEYOND CORE

An exercise categorized as “Beyond Core” (or “B”) is typically an exercise from the Core level but with an added complexity in algebra or precalculus skills. Most of the non-Core exercises done in lecture are B-level exercises, and students should generally have a lot of exposure (via lecture, recitation, or homework) to such exercises before the quizzes and exams.

A: ADVANCED

An exercise categorized as “Advanced” (or “A”) is one of the hardest exercises students will encounter in this course. We expect most students not to be able to fully solve these exercises, but that does not mean we expect students not to attempt these exercises. These exercises are nevertheless still a part of this course. These are the hardest examples possibly covered in lecture, but they are not always emphasized and they are seen in the homework only sparingly. Students who can solve these exercises are those students who go beyond our minimum expectations and study beyond what was seen in lecture.

The A-level exercises were designed primarily to distinguish between what we expect from B-level and A-level students. An A-level student understands the concepts at a fundamental level and *can apply these concepts correctly to exercises they have not seen before*.

R: REMOVED FROM SYLLABUS

These exercises cover topics or learning goals that have been removed the syllabus since they were introduced. They remain in these worksheets as an extra challenge to students and in case these topics are ever re-introduced into the course.

2.1 Chapter 1: Review of Algebra and Precalculus

§1.1, 1.2, 1.3, 1.4, 7.2, Appendix B

*Difficulty guide for this worksheet:**Core or Beyond Core:* all*Advanced:* none*Removed from syllabus:* none**Computation**

W1. For each of the following problems, zero or more of the choices are exact answers. Identify all of the exact answers, and *explain why the other choices are wrong*. If the exact value of the correct answer does not appear as one of the choices, find the exact value of the correct answer.

- (a) Find all real numbers x such that $x^2 = 2$.
A. 1.41 **B.** $\sqrt{2}$ **C.** ± 1.41 **D.** 1.41 and -1.41 **E.** $\pm\sqrt{2}$
- (b) Find all real numbers t such that $t^3 + 4 = 0$.
A. -1.59 **B.** ± 1.59 **C.** $\pm\sqrt[3]{-4}$ **D.** $-2^{2/3}$ **E.** no real solution
- (c) Find the circumference of a circle whose radius is 1.
A. 6.28 **B.** ± 6.283185 **C.** $\frac{44}{7}$
- (d) Find all real solutions to the equation $2^x = 3$.
A. 1.585 **B.** ± 1.585 **C.** 3^{-2} **D.** $\log_2(3)$ **E.** $\log_3(2)$ **F.** $\frac{\ln(3)}{\ln(2)}$ **G.** $\frac{1}{2}\log_2(9)$

Solution

- (a) The correct choice is **E**. Choices A, C, and D do not give exact solutions. Choice B is missing the solution $-\sqrt{2}$.
- (b) The correct choice is **D**. Every real number has a unique cube root, and so the only solution is $x = (-4)^{1/3}$, which may be written as $(-4)^{1/3} = (-1)^{1/3} \cdot (2^2)^{1/3} = -2^{2/3}$. Choice A is not an exact solution. Choice B is neither exact nor correct since each real number has only one cube root, not two. Choice C is incorrect because $-\sqrt[3]{-4}$ is not a solution.
- (c) All of the choices are incorrect since they are all not exact. The exact answer is 2π .
- (d) Choices **D**, **F**, and **G** are all correct. Choice A is not exact. Choice B is incorrect because -1.585 is not a solution. Choices C and E are incorrect because neither 3^{-2} nor $\log_3(2)$ is a solution.

Simplifying Algebraic Expressions

W2. Zero or more of the following statements are true for all real numbers a , x , and y . Determine which statements are true and determine which statements are false. For each false statement, find values of a , x , and y that make the statement false.

- (a) $a(x + y) = ax + ay$ (d) $a\sqrt{x + y} = \sqrt{a^2x + a^2y}$ (g) $\sqrt{x + y} = \sqrt{x} + \sqrt{y}$
 (b) $a(x + y)^2 = (ax + ay)^2$ (e) $\sin(x + y) = \sin(x) + \sin(y)$
 (c) $a(x + y)^2 = ax^2 + ay^2$ (f) $\cos(ax) = a \cos(x)$ (h) $\frac{a}{x + y} = \frac{a}{x} + \frac{a}{y}$

Solution

- (a) True.
- (b) False. Let $a = 2$, $x = 1$, and $y = 0$. The left side is 2 and the right side is 4.
- (c) False. Let $a = x = y = 1$. The left side is 4 and the right side is 2.
- (d) False. Let $a = -1$, $x = 1$, and $y = 0$. The left side is -1 and the right side is 1.
- (e) False. Let $x = y = \pi/2$. The left side is 0 and the right side is 2.
- (f) False. Let $a = x = 0$. The left side is 1 and the right side is 0.
- (g) False. Let $x = y = 1$. The left side is $\sqrt{2}$ and the right side is 2.
- (h) False. Let $a = x = y = 1$. The left side is $1/2$ and the right side is 2.

W3. Simplify each of the following expressions according to the instructions.

- (a) Positive exponents and integer coefficients only (assume $x, y > 0$): $\left(\frac{x^8 y^{-4}}{16 y^{4/3}}\right)^{-1/4}$
- (b) Positive exponents only (assume $a, b > 0$): $\frac{(9ab)^{3/2}}{(27a^3 b^{-4})^{2/3}} \cdot \left(\frac{3a^{-2}}{4b^{1/3}}\right)^{-1}$
- (c) Common factors canceled (assume $h \neq 5$): $\frac{2h - 10}{\sqrt{5} - \sqrt{h}}$
- (d) Expand and fully simplify: $(\sqrt{9s^2 + 4} + 2)(\sqrt{9s^2 + 4} - 2)$
- (e) Factor completely: $5y^2(y - 3)^5 + 10y(y - 3)^4$
- (f) Factor completely: $3x^3 + x^2 - 12x - 4$
- (g) Factor completely: $3x^{-1/2} + 4x^{1/2} + x^{3/2}$
- (h) Common factors canceled, positive exponents only ($x \neq y$ and $x, y \neq 0$): $\frac{y^{-1} - x^{-1}}{x^{-2} - y^{-2}}$
- (i) Common factors canceled ($u \neq 1$ and $u \neq -2$): $\frac{\frac{4}{u-1} - \frac{4}{u+2}}{\frac{3}{u^2 + u - 2} + \frac{3}{u+2}}$

Solution

- (a) $\frac{2y^{4/3}}{x^2}$
- (b) $4a^{3/2}b^{9/2}$
- (c) $-2(\sqrt{5} + \sqrt{h})$
- (d) $9s^2$
- (e) $5y(y - 1)(y - 2)(y - 3)^4$
- (f) $(3x + 1)(x - 2)(x + 2)$
- (g) $x^{-1/2}(x + 1)(x + 3)$
- (h) $\frac{-xy}{x + y}$
- (i) $4/u$

W4. For each given function $f(x)$, fully simplify the difference quotient $\frac{f(x+h) - f(x)}{h}$. Assume $h \neq 0$.

(a) $f(x) = 2x^2 - 2x$ (b) $f(x) = 9 - 5x$ (c) $f(x) = -4$ (d) $f(x) = \frac{1}{x}$

Solution

$$(a) \frac{2(x+h)^2 - 2(x+h) - (2x^2 - 2x)}{h} = 4x - 2 + 2h$$

$$(b) \frac{9 - 5(x+h) - (9 - 5x)}{h} = -5$$

$$(c) \frac{-4 - (-4)}{h} = 0$$

$$(d) \frac{\frac{1}{x+h} - \frac{1}{x}}{h} = -\frac{1}{x(x+h)}$$

Solving Algebraic Equations and Inequalities

W5. Solve each equation or inequality. (Parts (b) – (d) are related!)

(a) $p^2 = p + 1$

(f) $\frac{1-x}{1+x} + \frac{1+x}{1-x} = 6$

(j) $\frac{x+5}{x-2} = \frac{5}{x+2} + \frac{28}{x^2-4}$

(b) $2u^2 - 3u + 1 = 0$

(g) $3 \cos(x) + 2 \sin(x)^2 = 3$

(k) $t^2 - 4t - 5 > 0$

(c) $2x^{5/2} - 3x^{3/2} + x^{1/2} = 0$

(h) $|2x + 1| = 1$

(l) $\frac{x-4}{2x+1} < 0$

(d) $2 \sin(\theta)^2 - 3 \sin(\theta) + 1 = 0$

(i) $|3x - 5| = 4x$

(m) $\frac{x-4}{2x+1} < 5$

Solution

(a) Equivalently, $p^2 - p - 1 = 0$. The quadratic formula then gives the solutions: $p = \frac{1+\sqrt{5}}{2}$ or $p = \frac{1-\sqrt{5}}{2}$.

(b) Factoring gives $(2u - 1)(u - 1) = 0$, and so the solutions are $u = 1/2$ or $u = 1$.

(c) Factoring gives $x^{1/2}(2x - 1)(x - 1) = 0$, and so the solutions are $x = 0$, $x = 1/2$, or $x = 1$.

(d) Letting $u = \sin(\theta)$, we see the equation is equivalent to $2u^2 - 3u + 1 = 0$, which, from part (b), has solutions $u = 1/2$ or $u = 1$. So we seek all solutions to the equations $\sin(\theta) = 1/2$ and $\sin(\theta) = 1$. The equation $\sin(\theta) = 1/2$ has solutions $\theta = \frac{\pi}{6} + 2\pi n$ or $\theta = \frac{5\pi}{6} + 2\pi n$, where n is any integer. The equation $\sin(\theta) = 1$ has solutions $\theta = \frac{\pi}{2} + 2\pi n$, where n is any integer.

(e) Equivalently, we have $0 = x^2 - 2x = x(x - 2)$, and so the solutions are $x = 0$ or $x = 2$.

(f) Clearing denominators gives $(1-x)^2 + (1+x)^2 = 6(1-x)(1+x)$. Expanding each side and collecting like terms gives $2x^2 + 2 = 6 - 6x^2$. Equivalently, $8x^2 = 4$, and so the solutions are $x = \frac{1}{\sqrt{2}}$ or $x = -\frac{1}{\sqrt{2}}$.

(g) Using the identity $\sin(x)^2 = 1 - \cos(x)^2$ gives the equivalent equation $2 \cos(x)^2 - 3 \cos(x) + 1 = 0$. Factoring gives $(2 \cos(x) - 1)(\cos(x) - 1) = 0$. Hence we must solve the equations $2 \cos(x) - 1 = 0$ and $\cos(x) - 1 = 0$. The equation $2 \cos(x) - 1 = 0$ has solutions $x = \frac{\pi}{3} + 2\pi n$ or $x = -\frac{\pi}{3} + 2\pi n$ where n is any integer. The equation $\cos(x) - 1 = 0$ has solutions $x = 2\pi n$ where n is any integer.

(h) The given equation is equivalent to one of the equations $2x + 1 = 1$ or $2x + 1 = -1$. The solution to the former is $x = 0$ and the solution to the latter $x = -1$. Both candidate solutions are solutions to the original equation.

- (i) The given equation is equivalent to one of the equations $3x - 5 = 4x$ or $3x - 5 = -4x$. The solution to the former is $x = -5$ and the solution to the latter is $x = \frac{5}{7}$. Only $x = \frac{5}{7}$ is a solution to the original equation.
- (j) Clearing denominators gives $(x+5)(x+2) = 5(x-2)+28$, which is equivalent to $x^2+2x-8 = 0$, or $(x+4)(x-2) = 0$. Hence the candidate solutions are $x = -4$ or $x = 2$. However the expressions on each side of the original equation are undefined at $x = 2$, and so only $x = -4$ is a solution.
- (k) Factoring gives $(t+1)(t-5) > 0$, and so we consider a sign chart with cut points $t = -1$ and $t = 5$. That is, we test each of the intervals $(-\infty, -1)$, $(-1, 5)$, and $(5, \infty)$ with a single test point each to check whether the inequality is satisfied on that interval. Testing the points -2 , 0 , and 6 , we find that the inequality is *not* satisfied only on the interval $(-1, 5)$. Hence the solution is $(-\infty, -1) \cup (5, \infty)$.
- (l) The numerator vanishes when $x = 4$ and the denominator vanishes when $x = -1/2$. So we consider a sign chart with cut points $x = -1/2$ and $x = 4$. That is, we test each of the intervals $(-\infty, -1/2)$, $(-1/2, 4)$, and $(4, \infty)$ with a single test point each to check whether the inequality is satisfied on that interval. Testing the points -1 , 0 , and 5 , we find that the inequality is satisfied only on the interval $(-1/2, 4)$. Hence the solution is $(-1/2, 4)$.
- (m) First we subtract 5 from each side of the inequality to get it in the form $F(x) > 0$ or $F(x) < 0$. We find that the inequality is equivalent to $\frac{-9x-9}{2x+1} < 0$. The numerator vanishes when $x = -1$ and the denominator vanishes when $x = -1/2$. So we consider a sign chart with cut points $x = -1$ and $x = -1/2$. That is, we test each of the intervals $(-\infty, -1)$, $(-1, -1/2)$, and $(-1/2, \infty)$ with a single test point each to check whether the inequality is satisfied on that interval. Testing the points -2 , $-3/4$, and 0 , we find that the inequality is *not* satisfied only on the interval $(-1, -1/2)$. Hence the solution is $(-\infty, -1) \cup (-1/2, \infty)$.

Equations of Lines

W6. Find an equation of each described line.

- line through the point $(4, -6)$ with slope 3
- line through the points $(1, 2)$ and $(-3, 4)$
- line through the point $(5, 5)$ and perpendicular to the line described by $2x - 4y = 3$
- line through the point $(-1, -2)$ and parallel to the line described by $3x + 8y = 1$
- horizontal line through the point $(3, -1)$
- vertical line through the point $(2, -4)$

Solution

- $y - (-6) = 3(x - 4)$
- The slope is $m = \frac{4-2}{-3-1} = -\frac{1}{2}$, whence an equation of the line is $y - 2 = -\frac{1}{2}(x - 1)$.
- The slope of the given line is $\frac{1}{2}$, whence the equation of the desired line is $m = -2$, whence an equation of the desired line is $y - 5 = -2(x - 5)$.
- The slope of the given line is $-\frac{3}{8}$, whence the equation of the desired line is $m = -\frac{3}{8}$, whence an equation of the desired line is $y - (-2) = -\frac{3}{8}(x - (-1))$.
- $y = -1$
- $x = 2$

Functions, Domains, and Compositions

W7. If $f(x)$ and $g(x)$ are functions, then $f(g(x))$ is also a function, called the composition of f and g . We also write $f \circ g$ to mean $f(g(x))$. Similarly, $g \circ f$ means $g(f(x))$.

- (a) Let $f(x) = \sin(3x) + 7$ and $g(x) = e^{2x} + 1$. Write expressions for both $f(g(x))$ and $g(f(x))$.
 (b) Let $h(x) = \log_{10}(\sin(\sqrt{x}) + 1)$. Find four functions f_1, f_2, f_3 , and f_4 such that $h(x) = f_4(f_3(f_2(f_1(x))))$. You may not use the function $f(x) = x$ for any of your choices.

Solution

- (a) $f(g(x)) = \sin(3e^{2x} + 3) + 7$ and $g(f(x)) = e^{2\sin(3x)+14} + 1$.
 (b) One possible choice is the following: $f_1(x) = \sqrt{x}$, $f_2(x) = \sin(x)$, $f_3(x) = x + 1$, and $f_4(x) = \log_{10}(x)$.

W8. For each of the following function pairs, find a simplified formula for $f \circ g$ and $g \circ f$. Then find the domain of $f, g, f \circ g$, and $g \circ f$.

- (a) $f(x) = \sin(x)$ and $g(x) = 2x + 3$ (b) $f(x) = \frac{2+x}{1-2x}$ and $g(x) = \frac{x-2}{2x+1}$

Solution

- (a) The domain of both f and g is all real numbers. Hence the domain of $(f \circ g)(x) = \sin(2x+3)$ and $(g \circ f) = 2\sin(x) + 3$ is also all real numbers.
 (b) With some algebra we find the following:

$$(f \circ g)(x) = \frac{2 + \frac{x-2}{2x+1}}{1 - 2 \cdot \frac{x-2}{2x+1}} = x \quad , \quad (g \circ f)(x) = \frac{\frac{2+x}{1-2x} - 2}{2 \cdot \frac{2+x}{1-2x} + 1} = x$$

The domain of f is $x \neq \frac{1}{2}$ and the domain of g is $x \neq -\frac{1}{2}$. If x is in the domain of $f(g(x))$, then x must be in the domain of g (so $x \neq -\frac{1}{2}$) and $g(x)$ is in the domain of f (so $g(x) \neq \frac{1}{2}$). The equation $g(x) = \frac{1}{2}$ has no solution, so it is always true that $g(x) \neq \frac{1}{2}$. Hence the domain of $f \circ g$ is $x \neq -\frac{1}{2}$. Similarly, the domain of $g \circ f$ is $x \neq \frac{1}{2}$.

Exponential and Logarithmic Functions

W9. Find the exact value of each expression. Your final answer cannot contain “log” or “ln”.

- (a) $\log_2(48) - \log_2(6)$ (c) $\ln(\log_{10}(10^e))$
 (b) $\log_2(48) - \log_4(144)$ (d) $3^{\log_3(4e) - \log_3(e)}$

Solution

- (a) $\log_2(48) - \log_2(6) = \log_2(48/6) = \log_2(8) = \log_2(2^3) = 3$
 (b) First use the change-of-base formula to write $\log_4(144) = \frac{\log_2(144)}{\log_2(4)} = \frac{1}{2} \log_2(144) = \log_2(144^{1/2}) = \log_2(12)$. Now we have $\log_2(48) - \log_4(144) = \log_2(48) - \log_2(12) = \log_2(48/12) = \log_2(4) = \log_2(2^2) = 2$.

- (c) $\ln(\log_{10}(10^e)) = \ln(e) = 1$
 (d) $3^{\log_3(4e) - \log_3(e)} = 3^{\log_3(4e/e)} = 3^{\log_3(4)} = 4$

W10. Sketch the graph of each of the following functions.

(a) $f(x) = e^{-x}$

(b) $f(x) = \log_5(x)$

(c) $f(x) = -2^x$

(d) $f(x) = \log_{1/3}(x)$

Solution

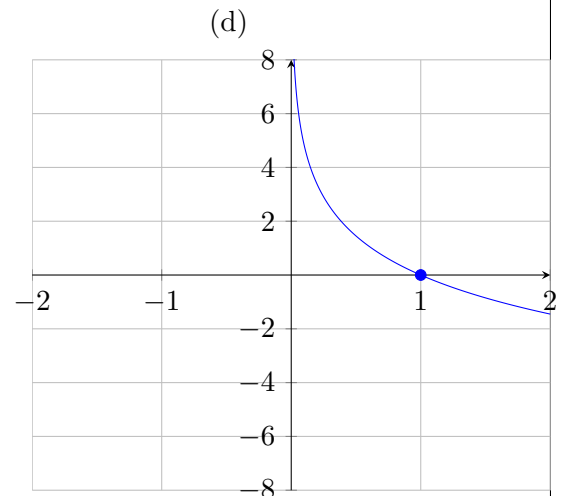
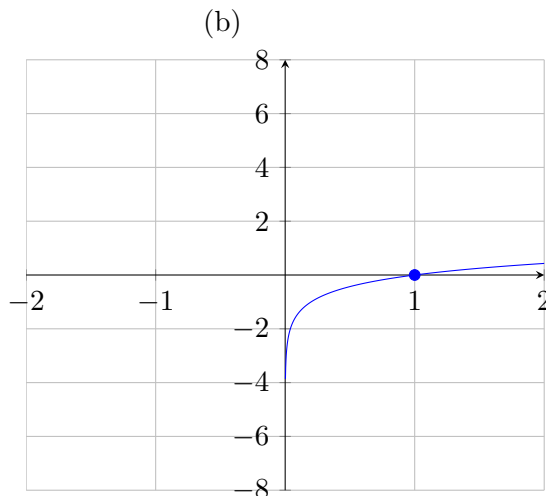
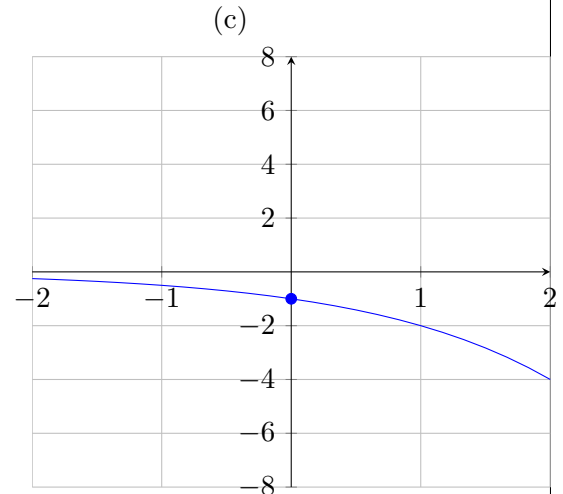
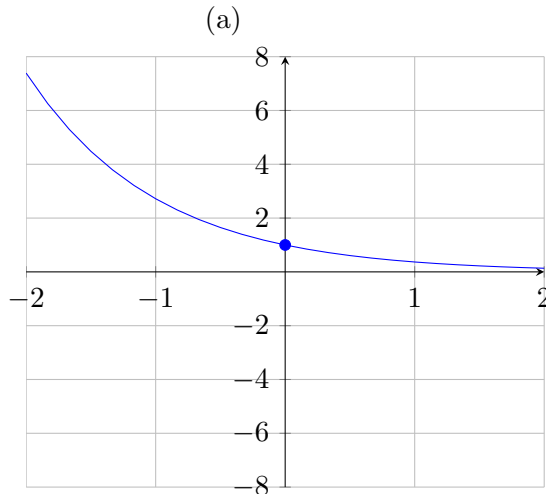

W11. Find all solutions to the following equations.

(a) $3^{x^2-x} = 9$

(b) $e^{2x+3} = 1$

(c) $\log_3(x) + \log_3(2x+1) = 1$

Solution

- (a) We have $3^{x^2-x} = 9 = 3^2$, and so $x^2 - x = 2$, or $(x+1)(x-2) = 0$. So the solutions are $x = -1$ or $x = 2$.
 (b) We have $e^{2x+3} = 1 = e^0$, and so $2x+3 = 0$. So the solution is $x = -3/2$.

(c) We have the following work.

$$\begin{aligned}\log_3(x) + \log_3(2x + 1) &= 1 \\ \log_3(x(2x + 1)) &= 1 \\ x(2x + 1) &= 3 \\ 2x^2 + x - 3 &= 0 \\ (2x + 3)(x - 1) &= 0\end{aligned}$$

Hence the candidate solutions are $x = 1$ and $x = -\frac{3}{2}$. Substitution of $x = -\frac{3}{2}$ in the original equation gives nonsense since the domain of all logarithms is strictly positive numbers. Hence the only solution is $x = 1$.

W12. Suppose $\log_{b^3}(5) = \frac{1}{6}$. Find the exact value of $\sqrt{b - 16}$.

Solution

By definition of logarithm, the equation $\log_{b^3}(5) = \frac{1}{6}$ is equivalent to $5 = (b^3)^{1/6}$. Hence $5 = b^{1/2}$, or $b = 25$. It follows that $\sqrt{b - 16} = \sqrt{25 - 16} = 3$.

Trigonometric Functions

W13. Write the exact values of the sine, cosine, and tangent of each of the following angles: $\pi/6$, $\pi/4$, $\pi/3$, $\pi/2$, $2\pi/3$, π , $-\pi/6$, and $-3\pi/4$. (You should do this without any reference or calculator.)

Solution

Refer to the table below.

θ	$\sin(\theta)$	$\cos(\theta)$	$\tan(\theta)$
$\pi/6$	$1/2$	$\sqrt{3}/2$	$1/\sqrt{3}$
$\pi/4$	$1/\sqrt{2}$	$1/\sqrt{2}$	1
$\pi/3$	$\sqrt{3}/2$	$1/2$	$\sqrt{3}$
$\pi/2$	1	0	undefined
$2\pi/3$	$\sqrt{3}/2$	$-1/2$	$-\sqrt{3}$
π	0	-1	0
$-\pi/6$	$-1/2$	$\sqrt{3}/2$	$-1/\sqrt{3}$
$-3\pi/4$	$-1/\sqrt{2}$	$-1/\sqrt{2}$	1

W14. Graph each of the following curves.

(a) $y = \sin(\theta)$

(b) $y = 3 \cos(\pi\theta)$

Solution

(a) The graph below shows one period of $y = \sin(\theta)$, on the interval $\theta \in [0, 2\pi]$.

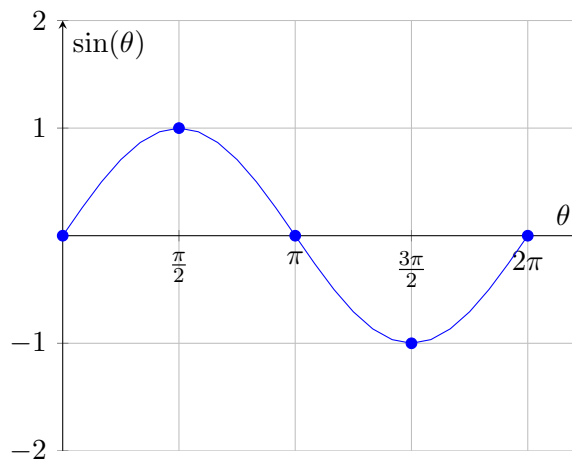

- (b) The graph below shows one period of $y = 3 \cos(\pi\theta)$, on the interval $\theta \in [0, 2]$. This graph can be calculated by starting with the graph of $y = \cos(\theta)$, and then stretching the graph vertically by a factor of 3 and shrinking the graph horizontally by a factor of π .

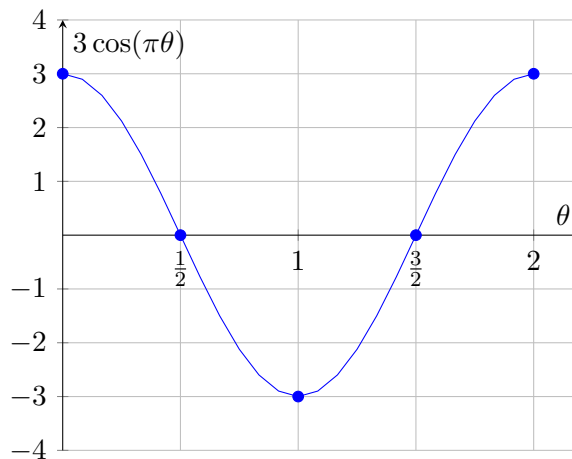

Modeling with Equations and Functions

- W15.** A bank pays 6% annual interest compounded continuously. How long will it take for \$835 to triple?

Solution

The value of the investment is $P(t) = P_0 e^{rt}$ with $r = 0.06$ and $P_0 = 835$. We desire the value of t such that $P(t) = 3P_0$, or $P_0 e^{rt} = 3P_0$, or $e^{rt} = 3$. Solving for t gives

$$t = \frac{\ln(3)}{r} = \frac{\ln(3)}{0.06}$$

- W16.** The number of bacteria in a certain petri dish obeys a law of exponential growth. Suppose there are initially 1000 bacteria and the number of bacteria doubles every 20 minutes. When will the number of bacteria reach 5000?

Solution

The bacteria population is generally $P(t) = P_0e^{kt}$ for unknown constants P_0 and k , with t measured in minutes. We are told that $P(0) = 1000$ and $P(20) = 2000$. Hence we have the equations $P_0 = 1000$ and $P_0e^{20k} = 2000$. Substituting $P_0 = 1000$ into the second equation gives $1000e^{20k} = 2000$, or $e^{20k} = 2$. Solving for k gives

$$k = \frac{\ln(2)}{20}$$

We now desire the value of t such that $P(t) = 5000$, and so we must solve the equation $1000e^{kt} = 5000$, or $e^{kt} = 5$. Solving for t gives

$$t = \frac{\ln(5)}{k} = 20 \cdot \frac{\ln(5)}{\ln(2)}$$

W17. A rectangular box is constructed according to the following rules.

- the length of the box is twice its width
 - the height of the box is 5 feet more than three times the length
- (a) If x is the width of the box in feet, write an expression for $V(x)$, the volume of the box in cubic feet as a function of its width.
- (b) Suppose the rules also require that the sum of the box's width and height to be no more than 26 feet. Under this condition, what is the domain of the function $V(x)$?

Solution

- (a) If $w = x$ is the width of the box, then the length is $\ell = 2x$ and the height is $h = 3\ell + 5 = 6x + 5$. Hence the volume of the box is $V(x) = \ell wh = (2x) \cdot x \cdot (6x + 5) = 2x^2(6x + 5)$.
- (b) We must have that $w + h \leq 26$, or $x + (6x + 5) \leq 26$. This is equivalent to $x \leq 3$. Of course, the width must also be non-negative, and so we must have $x \geq 0$. Hence the domain of $V(x)$ is $0 \leq x \leq 3$, or the interval $[0, 3]$.

W18. The total cost (in \$) of producing q units of some product is $C(q) = 30q^2 + 400q + 500$.

- (a) Compute the cost of making 20 units.
- (b) Compute the cost of making the 20th unit.
- (c) What is the initial setup cost?

Solution

- (a) $C(20) = 30(20)^2 + 400(20) + 500 = 20500$
- (b) $C(20) - C(19) = (30(20)^2 + 400(20) + 500) - (30(19)^2 + 400(19) + 500) = 1570$
- (c) The sunk cost is $C(0) = 500$.

W19. The speed of blood that is a distance r from the central axis in an artery of radius R is $v(r) = C(R^2 - r^2)$, where C is some constant.

- (a) What is the speed of the blood on the central axis?
- (b) What is the speed halfway between the central axis and the artery wall?

Solution

(a) $v(0) = CR^2$

(b) $v\left(\frac{R}{2}\right) = C\left(R^2 - \left(\frac{R}{2}\right)^2\right) = C\left(R^2 - \frac{1}{4}R^2\right) = \frac{3}{4}CR^2$

Miscellaneous

W20. Simplify the expression $\frac{|2-x|}{x-2}$ if $x > 2$.

Solution

If $x > 2$, then $2 - x < 0$, and so $|2 - x| = -(2 - x) = x - 2$. Hence $\frac{|2-x|}{x-2} = \frac{x-2}{x-2} = 1$.

W21. Find all solutions to the equation $2^{x^2-2x} = 8$.

Solution

The equation is equivalent to $2^{x^2-2x} = 2^3$, or $x^2 - 2x = 3$. After some algebra we have $(x - 3)(x + 1) = 0$, and so the solutions are $x = -1$ and $x = 3$.

W22. Simplify the expression $2^{\log_2(3) - \log_2(5)}$.

Solution

We have $2^{\log_2(3) - \log_2(5)} = 2^{\log_2(3/5)} = 3/5$.

W23. Find an equation of the line through the point $(-1, 4)$ with slope 2.

Solution

Use point-slope form of a line: $y - 4 = 2(x + 1)$.

W24. Find the domain of $f(x) = \frac{\ln(x)}{x-2}$. Write your answer in interval notation.

Solution

Note that the domain of $\ln(x)$ is $(0, \infty)$. Hence the domain of f is $(0, 2) \cup (2, \infty)$ (the value $x = 2$ must be excluded since $f(x)$ is undefined for $x = 2$ due to division by 0).

W25. Solve the inequality $\frac{3x+6}{x(x-4)} \leq 0$. Write your answer in interval notation.

Solution

Use the cut-point (or sign chart) method. For our sign chart, the cut points are found by setting the numerator and denominator to 0 separately. Hence the cut points are $x = -2$, $x = 0$, and $x = 4$. Now we test the truth of the inequality using one point from each corresponding subinterval.

interval	test point	sign of $\frac{3x+6}{x(x-4)}$
$(-\infty, -2)$	$x = -3$	$\frac{\ominus}{\ominus\ominus} = \ominus$
$(-2, 0)$	$x = -1$	$\frac{\oplus}{\ominus\ominus} = \oplus$
$(0, 4)$	$x = 1$	$\frac{\oplus}{\oplus\ominus} = \ominus$
$(4, \infty)$	$x = 5$	$\frac{\oplus}{\oplus\oplus} = \oplus$

Checking the cut points themselves, we see the inequality is satisfied at $x = -2$ but neither $x = 0$ nor $x = 4$. So the final answer is: $(-\infty, -2] \cup (0, 4)$.

- W26.** An account in a certain bank pays 5% annual interest, compounded continuously. An initial deposit of \$200 is made into the account. How many years does it take for the \$200 to double? *You must write an exact answer in terms of logarithms.*

Solution

The value of the account t years after the initial deposit is $P(t) = 200e^{0.05t}$. The time taken to double in value is the time T such that $P(T) = 400$. Solving the equation $200e^{0.05T} = 400$ gives $T = \ln(2)/0.05 = 20 \ln(2)$ years.

- W27.** A radioactive frog hops out of a pond full of nuclear waste. If its level of radioactivity declines to 1/3 of its original value in 30 days, when will its level of radioactivity reach 1/100 of its original value? *Hint: Use the exponential growth formula $P(t) = P_0e^{rt}$.*

Solution

Let $P(t)$ denote the radioactivity of the frog t days after jumping out of the pond and let P_0 denote the initial radioactivity. We are given that $P(30) = \frac{1}{3}P_0$, or $e^{30r} = \frac{1}{3}$, whence $r = -\frac{\ln(3)}{30}$. Given this value of r , the frog reaches $\frac{1}{100}$ of its original radioactivity at time T , where $P(T) = \frac{1}{100}P_0$, or $e^{rT} = \frac{1}{100}$. We thus find that

$$T = -\frac{\ln(100)}{r} = 30 \cdot \frac{\ln(100)}{\ln(3)}$$

2.2 Chapter 2: Limits

§2.1, 2.2: Introduction to Limits

Difficulty guide for this worksheet:

Core or Beyond Core: 28, 30

Advanced: 29

Removed from syllabus: none

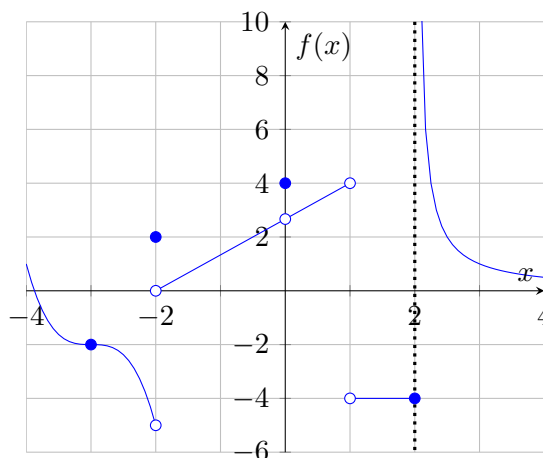
W28. Evaluate the following using the given graph.

- | | | | | |
|--------------------------------------|--------------------------------------|-------------------------------------|-------------------------------------|-------------------------------------|
| (a) $\lim_{x \rightarrow -3^-} f(x)$ | (e) $\lim_{x \rightarrow -2^-} f(x)$ | (i) $\lim_{x \rightarrow 0^-} f(x)$ | (m) $\lim_{x \rightarrow 1^-} f(x)$ | (q) $\lim_{x \rightarrow 2^-} f(x)$ |
| (b) $\lim_{x \rightarrow -3^+} f(x)$ | (f) $\lim_{x \rightarrow -2^+} f(x)$ | (j) $\lim_{x \rightarrow 0^+} f(x)$ | (n) $\lim_{x \rightarrow 1^+} f(x)$ | (r) $\lim_{x \rightarrow 2^+} f(x)$ |
| (c) $\lim_{x \rightarrow -3} f(x)$ | (g) $\lim_{x \rightarrow -2} f(x)$ | (k) $\lim_{x \rightarrow 0} f(x)$ | (o) $\lim_{x \rightarrow 1} f(x)$ | (s) $\lim_{x \rightarrow 2} f(x)$ |
| (d) $f(-3)$ | (h) $f(-2)$ | (l) $f(0)$ | (p) $f(1)$ | (t) $f(2)$ |

Solution

- | | | |
|---|---|--|
| (a) $\lim_{x \rightarrow -3^-} f(x) = -2$ | (g) $\lim_{x \rightarrow -2} f(x)$ DNE | (n) $\lim_{x \rightarrow 1^+} f(x) = -4$ |
| (b) $\lim_{x \rightarrow -3^+} f(x) = -2$ | (h) $f(-2) = 2$ | (o) $\lim_{x \rightarrow 1} f(x)$ DNE |
| (c) $\lim_{x \rightarrow -3} f(x) = -2$ | (i) $\lim_{x \rightarrow 0^-} f(x) = 8/3$ | (p) $f(1)$ DNE |
| (d) $f(-3) = -2$ | (j) $\lim_{x \rightarrow 0^+} f(x) = 8/3$ | (q) $\lim_{x \rightarrow 2^-} f(x) = -4$ |
| (e) $\lim_{x \rightarrow -2^-} f(x) = -5$ | (k) $\lim_{x \rightarrow 0} f(x) = 8/3$ | (r) $\lim_{x \rightarrow 2^+} f(x) = \infty$ |
| (f) $\lim_{x \rightarrow -2^+} f(x) = 0$ | (l) $f(0) = 4$ | (s) $\lim_{x \rightarrow 2} f(x)$ DNE |
| | (m) $\lim_{x \rightarrow 1^-} f(x) = 4$ | (t) $f(2) = -4$ |

W29. Suppose $\lim_{x \rightarrow 0} (f(x) + g(x))$ exists. Is it true that $\lim_{x \rightarrow 0} f(x)$ and $\lim_{x \rightarrow 0} g(x)$ also exist? Explain your answer.

Solution

No. Let $f(x)$ be *any* function such that $\lim_{x \rightarrow 0} f(x)$ does not exist. (For example, $f(x) = \frac{|x|}{x}$.) Let $g(x) = -f(x)$. Then it is trivial that

$$\lim_{x \rightarrow 0} (f(x) + g(x)) = \lim_{x \rightarrow 0} (f(x) - f(x)) = \lim_{x \rightarrow 0} (0) = 0$$

Hence $\lim_{x \rightarrow 0} (f(x) + g(x))$ exists but neither $\lim_{x \rightarrow 0} f(x)$ nor $\lim_{x \rightarrow 0} g(x)$ exists.

W30. Suppose $\lim_{x \rightarrow 2} \left(\frac{f(x) - 3}{x - 2} \right) = 5$ and $\lim_{x \rightarrow 2} f(x)$ exists (and is equal to $f(2)$). What is the value of $f(2)$? Explain your answer.

Solution

Direct substitution of $x = 2$ in the limit gives the undefined expression $\left(\frac{f(2) - 3}{0} \right)$. If $f(2)$ were anything other than 3, this would give us an expression of the form $\frac{c}{0}$ where $c \neq 0$. This would mean that the limit could not exist. (We will study infinite limits in more detail in chapter 4.)

The only possible way that the given limit could exist (we know it exists because it is equal to 5) while still having the division by 0 from direct substitution is if there were actually some cancellation in the numerator $f(x) - 3$. That is, we would need $f(2) = 3$ for direct substitution to give us $\frac{0}{0}$. Hence $f(2) = 3$.

§2.3: Techniques for Computing Limits

Difficulty guide for this worksheet:

Core or Beyond Core: 31 (all parts except j, k, l, or u)

Advanced: 31j, 31k, 31l, 31u

Removed from syllabus: none

W31. For each of the following, evaluate the limit or explain why it does not exist. Show all work.

(a) $\lim_{x \rightarrow 2} \left(\frac{x^2 + 3x - 1}{x + \sin(\pi x)} \right)$

(b) $\lim_{x \rightarrow 1} (x^4 - 9x)^{1/3}$

(c) $\lim_{x \rightarrow -3} \left(\frac{x^2 - 9}{x^3 + x^2 - 6x} \right)$

(d) $\lim_{x \rightarrow 1} \left(\frac{\sqrt{23 - 7x} - 4}{x - 1} \right)$

(e) $\lim_{h \rightarrow 0} \left(\frac{(x+h)^{-2} - x^{-2}}{h} \right)$

(f) $\lim_{x \rightarrow 0} \left(\frac{1}{x} - \frac{1}{x^2 + x} \right)$

(g) $\lim_{x \rightarrow 1} \left(\frac{\frac{1}{x} - 1}{\sqrt{x} - 1} \right)$

(h) $\lim_{x \rightarrow 0} |x|$

(i) $\lim_{x \rightarrow 8} \left(\frac{|x - 8|}{x - 8} \right)$

(j) $\lim_{x \rightarrow 8^-} \left(\frac{|x^2 - 64|}{x - 8} \right)$

(k) $\lim_{x \rightarrow 0^+} \left(\frac{1}{x} - \frac{1}{|x|} \right)$

(l) $\lim_{x \rightarrow 0^-} \left(\frac{1}{x} - \frac{1}{|x|} \right)$

(m) $\lim_{x \rightarrow 0} \left(\frac{\sin(\pi x)}{x} \right)$

(n) $\lim_{x \rightarrow 0} \left(\frac{\sec(x) - 1}{x \sec(x)} \right)$

(o) $\lim_{x \rightarrow 0} \left(\frac{1 - \cos(x)}{\sin(x)} \right)$

(p) $\lim_{x \rightarrow 2} \left(\frac{\sin(6 - 3x)}{5x - 10} \right)$

(q) $\lim_{x \rightarrow \pi} \left(\frac{\tan(x - \pi)}{x - \pi} \right)$

(r) $\lim_{x \rightarrow 0} \left(\frac{\sin(2x)^2 \cos(3x)}{\tan(5x) \sin(7x)} \right)$

(s) $\lim_{x \rightarrow -1} g(x)$ where

$$g(x) = \begin{cases} 4x - 5 & , \quad x < -1 \\ x^3 + x & , \quad x \geq -1 \end{cases}$$

(t) $\lim_{x \rightarrow 2} f(x)$ where

$$f(x) = \begin{cases} \frac{x^2 - 2x}{x - 2} & , \quad x < 2 \\ \sqrt{x + 2} & , \quad x > 2 \end{cases}$$

(u) $\lim_{x \rightarrow a} \frac{\cos\left(\frac{\pi a}{2x}\right)}{x - a}$

Solution

(a) Direct substitution.

$$\lim_{x \rightarrow 2} \left(\frac{x^2 + 3x - 1}{x + \sin(\pi x)} \right) = \frac{2^2 + 3(2) - 1}{2 + \sin(2\pi)} = \frac{9}{2}$$

(b) Direct substitution.

$$\lim_{x \rightarrow 1} (x^4 - 9x)^{1/3} = (1^4 - 9(1))^{1/3} = (-8)^{1/3} = -2$$

(c) Factor and cancel.

$$\begin{aligned}\lim_{x \rightarrow -3} \left(\frac{x^2 - 9}{x^3 + x^2 - 6x} \right) &= \lim_{x \rightarrow -3} \left(\frac{(x-3)(x+3)}{x(x-2)(x+3)} \right) = \lim_{x \rightarrow -3} \left(\frac{x-3}{x(x-2)} \right) \\ &= \frac{-3-3}{(-3)(-3-2)} = -\frac{2}{5}\end{aligned}$$

(d) Rationalize numerator, then factor and cancel.

$$\begin{aligned}\lim_{x \rightarrow 1} \left(\frac{\sqrt{23-7x}-4}{x-1} \right) &= \lim_{x \rightarrow 1} \left(\frac{\sqrt{23-7x}-4}{x-1} \cdot \frac{\sqrt{23-7x}+4}{\sqrt{23-7x}+4} \right) \\ &= \lim_{x \rightarrow 1} \left(\frac{(23-7x)-16}{(x-1)(\sqrt{23-7x}+4)} \right) \\ &= \lim_{x \rightarrow 1} \left(\frac{-7(x-1)}{(x-1)(\sqrt{23-7x}+4)} \right) \\ &= \lim_{x \rightarrow 1} \left(\frac{-7}{\sqrt{23-7x}+4} \right) = -\frac{7}{\sqrt{23-7}+4} = -\frac{7}{8}\end{aligned}$$

(e) Find common denominator, expand numerator, then factor and cancel.

$$\begin{aligned}\lim_{h \rightarrow 0} \left(\frac{(x+h)^{-2} - x^{-2}}{h} \right) &= \lim_{h \rightarrow 0} \left(\frac{\frac{1}{(x+h)^2} - \frac{1}{x^2}}{h} \right) = \lim_{h \rightarrow 0} \left(\frac{x^2 - (x+h)^2}{hx^2(x+h)^2} \right) \\ &= \lim_{h \rightarrow 0} \left(\frac{x^2 - (x^2 + 2xh + h^2)}{hx^2(x+h)^2} \right) = \lim_{h \rightarrow 0} \left(\frac{-h(2x+h)}{hx^2(x+h)^2} \right) \\ &= \lim_{h \rightarrow 0} \left(\frac{-(2x+h)}{x^2(x+h)^2} \right) = -\frac{2x}{x^2 \cdot x^2} = -\frac{2}{x^3}\end{aligned}$$

(f) Find common denominator, then factor and cancel.

$$\begin{aligned}\lim_{x \rightarrow 0} \left(\frac{1}{x} - \frac{1}{x^2 + x} \right) &= \lim_{x \rightarrow 0} \left(\frac{(x+1) - 1}{x(x+1)} \right) = \lim_{x \rightarrow 0} \left(\frac{x}{x(x+1)} \right) \\ &= \lim_{x \rightarrow 0} \left(\frac{1}{x+1} \right) = \frac{1}{0+1} = 1\end{aligned}$$

(g) Find common denominator for numerator. Then rationalize denominator, factor and cancel.

$$\begin{aligned}\lim_{x \rightarrow 1} \left(\frac{\frac{1}{x} - 1}{\sqrt{x} - 1} \right) &= \lim_{x \rightarrow 1} \left(\frac{\frac{1-x}{x}}{\sqrt{x} - 1} \right) = \lim_{x \rightarrow 1} \left(\frac{1-x}{x(\sqrt{x}-1)} \right) \\ &= \lim_{x \rightarrow 1} \left(\frac{1-x}{x(\sqrt{x}-1)} \cdot \frac{\sqrt{x}+1}{\sqrt{x}+1} \right) = \lim_{x \rightarrow 1} \left(\frac{(1-x)(\sqrt{x}+1)}{x(x-1)} \right) \\ &= \lim_{x \rightarrow 1} \left(\frac{-(x-1)(\sqrt{x}+1)}{x(x-1)} \right) = \lim_{x \rightarrow 1} \left(\frac{-(\sqrt{x}+1)}{x} \right) \\ &= -\frac{\sqrt{1}+1}{1} = -2\end{aligned}$$

(h) Write as piecewise function and compute one-sided limits.

$$|x| = \begin{cases} -x & , \quad x < 0 \\ x & , \quad x \geq 0 \end{cases}$$

Hence we have

$$\begin{aligned} \lim_{x \rightarrow 0^-} |x| &= \lim_{x \rightarrow 0^-} (-x) = -0 = 0 \\ \lim_{x \rightarrow 0^+} |x| &= \lim_{x \rightarrow 0^+} (x) = 0 \end{aligned}$$

The one-sided limits exist and are equal. Hence

$$\lim_{x \rightarrow 0} |x| = 0$$

(i) Write as piecewise function and compute one-sided limits.

$$\frac{|x-8|}{x-8} = \begin{cases} \frac{-(x-8)}{x-8} & , \quad x-8 < 0 \\ \frac{x-8}{x-8} & , \quad x-8 > 0 \end{cases} = \begin{cases} -1 & , \quad x < 8 \\ 1 & , \quad x > 8 \end{cases}$$

Hence we have

$$\begin{aligned} \lim_{x \rightarrow 8^-} \left(\frac{|x-8|}{x-8} \right) &= \lim_{x \rightarrow 8^-} (-1) = -1 \\ \lim_{x \rightarrow 8^+} \left(\frac{|x-8|}{x-8} \right) &= \lim_{x \rightarrow 8^+} (1) = 1 \end{aligned}$$

The one-sided limits exist but are not equal. Hence

$$\lim_{x \rightarrow 8} \left(\frac{|x-8|}{x-8} \right) \text{ does not exist.}$$

(j) Consider absolute value as a piecewise function. If $x \rightarrow 8^-$, then we may assume $x-8$ is a small, negative number. (For example, $x = 7.999$ would be such a number.) That is, $0 < x < 8$. Hence $0 < x^2 < 64$, or $x^2 - 64 < 0$. This means that if $x \rightarrow 8^-$, then

$$\frac{|x^2 - 64|}{x-8} = \frac{-(x^2 - 64)}{x-8} = \frac{-(x-8)(x+8)}{x-8} = -(x+8)$$

Computing the desired limit then gives

$$\lim_{x \rightarrow 8^-} \left(\frac{|x^2 - 64|}{x-8} \right) = \lim_{x \rightarrow 8^-} (-(x+8)) = -(8+8) = -16$$

(k) Write as piecewise function and compute one-sided limits.

$$\frac{1}{x} - \frac{1}{|x|} = \begin{cases} \frac{1}{x} - \frac{1}{-x} & , \quad x < 0 \\ \frac{1}{x} - \frac{1}{x} & , \quad x > 0 \end{cases} = \begin{cases} \frac{2}{x} & , \quad x < 0 \\ 0 & , \quad x > 0 \end{cases}$$

Hence we have

$$\lim_{x \rightarrow 0^+} \left(\frac{1}{x} - \frac{1}{|x|} \right) = \lim_{x \rightarrow 0^+} (0) = 0$$

- (l) From the work done in the previous problem, we now have

$$\lim_{x \rightarrow 0^-} \left(\frac{1}{x} - \frac{1}{|x|} \right) = \lim_{x \rightarrow 0^-} \left(\frac{2}{x} \right) = -\infty$$

We will study infinite limits in more detail later. For now, we argue as follows.

If x is very small, then $\frac{2}{x}$ is very large. (Think of taking the reciprocal of a very small number: what happens?) But since $x \rightarrow 0^-$, we have that x is also negative. Hence $\frac{2}{x}$ is a negative, arbitrarily large number as $x \rightarrow 0^-$. Hence the limit is $-\infty$.

- (m) Make the change of variable $\theta = \pi x$, then use the limit $\lim_{\theta \rightarrow 0} \left(\frac{\sin(\theta)}{\theta} \right) = 1$

$$\begin{aligned} \lim_{x \rightarrow 0} \left(\frac{\sin(\pi x)}{x} \right) &= \lim_{x \rightarrow 0} \left(\pi \cdot \frac{\sin(\pi x)}{\pi x} \right) = \pi \cdot \lim_{x \rightarrow 0} \left(\frac{\sin(\pi x)}{\pi x} \right) \\ &= \pi \cdot \lim_{\theta \rightarrow 0} \left(\frac{\sin(\theta)}{\theta} \right) = \pi \cdot 1 = \pi \end{aligned}$$

- (n) Write in terms of sine and cosine only first. Then exploit the Pythagorean identity $\cos(\theta)^2 + \sin(\theta)^2 = 1$. Finally use the limit $\lim_{\theta \rightarrow 0} \left(\frac{\sin(\theta)}{\theta} \right) = 1$.

$$\begin{aligned} \lim_{x \rightarrow 0} \left(\frac{\sec(x) - 1}{x \sec(x)} \right) &= \lim_{x \rightarrow 0} \left(\frac{\frac{1}{\cos(x)} - 1}{x \cdot \frac{1}{\cos(x)}} \right) = \lim_{x \rightarrow 0} \left(\frac{1 - \cos(x)}{x} \right) \\ &= \lim_{x \rightarrow 0} \left(\frac{1 - \cos(x)}{x} \cdot \frac{1 + \cos(x)}{1 + \cos(x)} \right) = \lim_{x \rightarrow 0} \left(\frac{1 - \cos(x)^2}{x(1 + \cos(x))} \right) \\ &= \lim_{x \rightarrow 0} \left(\frac{\sin(x)^2}{x(1 + \cos(x))} \right) = \lim_{x \rightarrow 0} \left(\frac{\sin(x)}{x} \cdot \frac{\sin(x)}{1 + \cos(x)} \right) \\ &= \lim_{x \rightarrow 0} \left(\frac{\sin(x)}{x} \right) \cdot \lim_{x \rightarrow 0} \left(\frac{\sin(x)}{1 + \cos(x)} \right) = 1 \cdot \frac{0}{1 + 1} = 0 \end{aligned}$$

- (o) Exploit the Pythagorean identity $\cos(\theta)^2 + \sin(\theta)^2 = 1$.

$$\begin{aligned} \lim_{x \rightarrow 0} \left(\frac{1 - \cos(x)}{\sin(x)} \right) &= \lim_{x \rightarrow 0} \left(\frac{1 - \cos(x)}{\sin(x)} \cdot \frac{1 + \cos(x)}{1 + \cos(x)} \right) \\ &= \lim_{x \rightarrow 0} \left(\frac{1 - \cos(x)^2}{\sin(x)(1 + \cos(x))} \right) = \lim_{x \rightarrow 0} \left(\frac{\sin(x)^2}{\sin(x)(1 + \cos(x))} \right) \\ &= \lim_{x \rightarrow 0} \left(\frac{\sin(x)}{1 + \cos(x)} \right) = \frac{0}{1 + 1} = 0 \end{aligned}$$

- (p) Make the change of variable $\theta = 6 - 3x$ (note that if $x \rightarrow 2$, then $\theta \rightarrow 0$). Then use the limit $\lim_{\theta \rightarrow 0} \left(\frac{\sin(\theta)}{\theta} \right) = 1$.

$$\begin{aligned} \lim_{x \rightarrow 2} \left(\frac{\sin(6 - 3x)}{5x - 10} \right) &= \lim_{x \rightarrow 2} \left(\frac{\sin(6 - 3x)}{-5(2 - x)} \right) = \lim_{x \rightarrow 2} \left(\frac{\sin(6 - 3x)}{-\frac{5}{3}(6 - 3x)} \right) \\ &= \lim_{\theta \rightarrow 0} \left(\frac{\sin(\theta)}{-\frac{5}{3}\theta} \right) = -\frac{3}{5} \cdot \lim_{\theta \rightarrow 0} \left(\frac{\sin(\theta)}{\theta} \right) = -\frac{3}{5} \cdot 1 = -\frac{3}{5} \end{aligned}$$

- (q) Write in terms of sine and cosine only first. Make the change of variable $\theta = x - \pi$ (note that if $x \rightarrow \pi$, then $\theta \rightarrow 0$). Finally use the limit $\lim_{\theta \rightarrow 0} \left(\frac{\sin(\theta)}{\theta} \right) = 1$.

$$\begin{aligned} \lim_{x \rightarrow \pi} \left(\frac{\tan(x - \pi)}{x - \pi} \right) &= \lim_{x \rightarrow \pi} \left(\frac{\sin(x - \pi)}{(x - \pi) \cos(x - \pi)} \right) = \lim_{\theta \rightarrow 0} \left(\frac{\sin(\theta)}{\theta \cos(\theta)} \right) \\ &= \lim_{\theta \rightarrow 0} \left(\frac{\sin(\theta)}{\theta} \right) \cdot \lim_{\theta \rightarrow 0} \left(\frac{1}{\cos(\theta)} \right) = 1 \cdot \frac{1}{1} = 1 \end{aligned}$$

- (r) Write in terms of sine and cosine only first. Then repeatedly use the limit $\lim_{\theta \rightarrow 0} \left(\frac{\sin(\theta)}{\theta} \right) = 1$ with appropriate changes of variable and added factors.

$$\begin{aligned} &= \lim_{x \rightarrow 0} \left(\frac{\sin(2x) \sin(2x) \cos(5x) \cos(3x)}{\sin(5x) \sin(7x)} \right) \\ &= \lim_{x \rightarrow 0} \left(\frac{\sin(2x)}{2x} \cdot \frac{\sin(2x)}{2x} \cdot \frac{5x}{\sin(5x)} \cdot \frac{7x}{\sin(7x)} \cdot \frac{\cos(5x) \cos(3x)}{1} \cdot \frac{(2x)(2x)}{(5x)(7x)} \right) \end{aligned}$$

Note that each limit of the form $\lim_{x \rightarrow 0} \left(\frac{\sin(ax)}{ax} \right)$ or $\lim_{x \rightarrow 0} \left(\frac{ax}{\sin(ax)} \right)$ is equal to 1. So continuing our work, we have

$$\begin{aligned} &= 1 \cdot 1 \cdot 1 \cdot 1 \cdot \lim_{x \rightarrow 0} \left(\frac{\cos(5x) \cos(3x)}{1} \cdot \frac{4x^2}{35x^2} \right) \\ &= \left(\frac{\cos(5x) \cos(3x)}{1} \cdot \frac{4}{35} \right) = 1 \cdot 1 \cdot \frac{4}{35} = \frac{4}{35} \end{aligned}$$

- (s) Compute one-sided limits.

$$\begin{aligned} \lim_{x \rightarrow -1^-} g(x) &= \lim_{x \rightarrow -1^-} (4x - 5) = 4(-1) - 5 = -9 \\ \lim_{x \rightarrow -1^+} g(x) &= \lim_{x \rightarrow -1^+} (x^3 + x) = (-1)^3 + (-1) = -2 \end{aligned}$$

The one-sided limits exist but are not equal. Hence

$$\lim_{x \rightarrow -1} g(x) \text{ does not exist.}$$

- (t) Compute one-sided limits. For the left limit, factor and cancel.

$$\begin{aligned} \lim_{x \rightarrow 2^-} f(x) &= \lim_{x \rightarrow 2^-} \left(\frac{x^2 - 2x}{x - 2} \right) = \lim_{x \rightarrow 2^-} \left(\frac{x(x - 2)}{x - 2} \right) = \lim_{x \rightarrow 2^-} (x) = 2 \\ \lim_{x \rightarrow 2^+} f(x) &= \lim_{x \rightarrow 2^+} (\sqrt{x + 2}) = \sqrt{2 + 2} = 2 \end{aligned}$$

The one-sided limits exist and are equal. Hence

$$\lim_{x \rightarrow 2} f(x) = 2$$

- (u) This limit is tough, but we can compute it with all of the methods we have learned so far. Note that direct substitution of $x = a$ gives $0/0$, so we have to use some algebra or trigonometric identities to compute the limit. Our first goal will be to write the expression inside the limit symbol as an equivalent expression for which we can use the special limit

$$\lim_{\theta \rightarrow 0} \frac{\sin(\theta)}{\theta} = 1$$

First we use the identity $\cos(\alpha) = \sin\left(\frac{\pi}{2} - \alpha\right)$.

$$\frac{\cos\left(\frac{\pi a}{2x}\right)}{x - a} = \frac{\sin\left(\frac{\pi}{2} - \frac{\pi a}{2x}\right)}{x - a}$$

Now we change variables. Since we want to use the special limit involving sine, we let θ equal the argument of sine. That is, we let

$$\theta = \frac{\pi}{2} - \frac{\pi a}{2x}$$

When we change variables, we have to change both the limit symbol and the expression for which we are computing the limit. First let's change the expression. Given our definition of θ , some algebra shows that

$$x = \frac{a}{1 - \frac{2\theta}{\pi}}$$

Second, observe that if $x \rightarrow a$, then $\theta \rightarrow 0$. So altogether we have the following.

$$\lim_{x \rightarrow a} \frac{\cos\left(\frac{\pi a}{2x}\right)}{x - a} = \lim_{x \rightarrow a} \frac{\sin\left(\frac{\pi}{2} - \frac{\pi a}{2x}\right)}{x - a} = \lim_{\theta \rightarrow 0} \frac{\sin(\theta)}{\frac{a}{1 - \frac{2\theta}{\pi}} - a}$$

Now look at just the denominator and use some algebra to simplify.

$$\frac{a}{1 - \frac{2\theta}{\pi}} - a = \frac{2a\theta}{\pi - 2\theta}$$

Now substitute this back into our limit.

$$\lim_{\theta \rightarrow 0} \frac{\sin(\theta)}{\frac{a}{1 - \frac{2\theta}{\pi}} - a} = \lim_{\theta \rightarrow 0} \frac{\sin(\theta)}{\frac{2a\theta}{\pi - 2\theta}} = \lim_{\theta \rightarrow 0} \left(\frac{\pi - 2\theta}{2a} \cdot \frac{\sin(\theta)}{\theta} \right)$$

Now we can finally use the special limit ($\lim_{\theta \rightarrow 0} \frac{\sin(\theta)}{\theta} = 1$) to compute our limit.

$$\lim_{x \rightarrow a} \frac{\cos\left(\frac{\pi a}{2x}\right)}{x - a} = \lim_{\theta \rightarrow 0} \left(\frac{\pi - 2\theta}{2a} \cdot \frac{\sin(\theta)}{\theta} \right) = \frac{\pi - 0}{2a} \cdot 1 = \frac{\pi}{2a}$$

§2.4: Infinite Limits

*Difficulty guide for this worksheet:**Core or Beyond Core:* 32 (all parts except c), 33 (all parts except f)*Advanced:* 32c, 33f*Removed from syllabus:* none**W32.** For each part, calculate the limit or show that it does not exist. Show all work.

$$(a) \lim_{x \rightarrow 0^+} \left(\frac{x^2 - x + 4}{2x + \sin(x)} \right) \quad (b) \lim_{x \rightarrow 3^-} \left(\frac{2x^2 + 8}{x^2 - 9} \right) \quad (c) \lim_{x \rightarrow 4^+} \left(\frac{|16 - x^2|}{x - 4} \right)$$

Solution

- (a) Substitution of $x = 0$ gives $\frac{4}{0}$, which indicates that the one-sided limit is infinite. Now we do sign analysis to determine the sign of infinity. If $x \rightarrow 0^+$, we may assume x is a small positive number. In that case, both terms in the denominator (i.e., both $2x$ and $\sin(x)$) are also small positive numbers. Hence $2x + \sin(x)$ approaches 0 but remains positive. So we have

$$\lim_{x \rightarrow 0^+} \left(\frac{x^2 - x + 4}{2x + \sin(x)} \right) = \frac{4}{0^+} = +\infty$$

- (b) Substitution of $x = 3$ gives $\frac{26}{0}$, which indicates that the one-sided limit is infinite. Now we do sign analysis to determine the sign of infinity. If $x \rightarrow 3^-$, we may assume x is slightly less than 3. In that case, the denominator (i.e., $x^2 - 9$) is a small negative number. Hence $x^2 - 9$ approaches 0 but remains negative. So we have

$$\lim_{x \rightarrow 3^-} \left(\frac{2x^2 + 8}{x^2 - 9} \right) = \frac{26}{0^-} = -\infty$$

- (c) Substitution of $x = 4$ gives $\frac{0}{0}$, which does not necessarily indicate an infinite limit, but rather that there may be algebraic cancelation. Note that if $x \rightarrow 4^+$, then we may assume x is slightly greater than 4. This means x^2 is slightly greater than 16, so that $x^2 - 16 > 0$. Hence $|16 - x^2| = x^2 - 16$. So now we have

$$\lim_{x \rightarrow 4^+} \left(\frac{|16 - x^2|}{x - 4} \right) = \lim_{x \rightarrow 4^+} \left(\frac{x^2 - 16}{x - 4} \right) = \lim_{x \rightarrow 4^+} (x + 4) = 4 + 4 = 8$$

W33. For each function, find the vertical asymptotes and, at each vertical asymptote of f , find both corresponding one-sided limits.

$$(a) f(x) = \frac{(x-1)(2x+5)}{(x+1)(3x-6)} \quad (c) f(x) = \frac{(x-4)\sin(x)}{x^3 - 8x^2 + 16x} \quad (e) f(x) = \frac{2e^x + 3}{1 - e^x}$$

$$(b) f(x) = \frac{x^2 - 18x + 81}{x^2 - 81} \quad (d) f(x) = \ln(x) \quad (f) f(x) = e^{-1/x}$$

Solution

- (a) Candidate vertical asymptotes occur at x -values where $(x+1)(3x-6) = 0$. Hence the candidate vertical asymptotes are the lines $x = -1$ and $x = 2$. Direct substitution of either $x = -1$ or $x = 2$ into $f(x)$ gives “nonzero number divided by 0”, hence both $x = -1$ and $x = 2$ are vertical asymptotes. Now for the one-sided limits.

First we calculate the one-sided limits at $x = -1$. Substitution of $x = -1$ gives $\frac{(-2)(3)}{0}$, which indicates that both one-sided limits are infinite. So we perform a sign analysis on each factor in $f(x)$. Remember that factors that approach a non-zero number have a definite sign. But factors that approach 0 have a sign that is determined by whether the one-sided limit is from the left or the right. (So this means that $x + 1$ can be negative or positive depending on whether the limit is from the left or the right.)

$$\begin{aligned}\lim_{x \rightarrow -1^-} \left(\frac{(x-1)(2x+5)}{(x+1)(3x-6)} \right) &= \frac{\ominus \oplus}{\ominus \ominus} \infty = -\infty \\ \lim_{x \rightarrow -1^+} \left(\frac{(x-1)(2x+5)}{(x+1)(3x-6)} \right) &= \frac{\ominus \oplus}{\oplus \ominus} \infty = \infty\end{aligned}$$

Now we do the same with $x = 2$. Substitution of $x = 2$ gives $\frac{(1)(9)}{0}$, which again indicates the one-sided limits are infinite. So we perform a sign analysis on each factor.

$$\begin{aligned}\lim_{x \rightarrow 2^-} \left(\frac{(x-1)(2x+5)}{(x+1)(3x-6)} \right) &= \frac{\oplus \oplus}{\oplus \ominus} \infty = -\infty \\ \lim_{x \rightarrow 2^+} \left(\frac{(x-1)(2x+5)}{(x+1)(3x-6)} \right) &= \frac{\oplus \oplus}{\oplus \oplus} \infty = \infty\end{aligned}$$

- (b) Setting the denominator to 0, we see that the only candidate asymptotes are $x = -9$ and $x = 9$. Direct substitution of $x = -9$ gives “ $\frac{18^2}{0}$ ” (nonzero number divided by 0), whence $x = -9$ is a vertical asymptote. Direct substitution of $x = 9$, however, gives “ $\frac{0}{0}$ ”, and so we need more analysis.

For $x = 9$, we have the following:

$$\lim_{x \rightarrow 9} \left(\frac{x^2 - 18x + 81}{x^2 - 81} \right) = \lim_{x \rightarrow 9} \left(\frac{(x-9)^2}{(x-9)(x+9)} \right) = \lim_{x \rightarrow 9} \left(\frac{x-9}{x+9} \right) = \frac{0}{18} = 0$$

Since this limit is not infinite, we conclude that $x = 9$ is not a vertical asymptote.

For $x = -9$, we use the simplified form of f : $f(x) = \frac{x-9}{x+9}$. We already know that the one-sided limits are infinite. We now perform a sign analysis. Testing $x = -9.01$ (for the left limit) and $x = -8.99$ (for the right limit), we find the following:

$$\lim_{x \rightarrow -9^-} f(x) = \frac{-18}{0^-} = +\infty, \quad \lim_{x \rightarrow -9^+} f(x) = \frac{-18}{0^+} = -\infty$$

- (c) Setting the denominator to 0, we have $x^3 - 8x + 16x = x(x-4)^2 = 0$, and so the only candidate vertical asymptotes are $x = 0$ and $x = 4$. Direct substitution of either $x = 0$ or $x = 4$ gives “ $\frac{0}{0}$ ”, which means we need more analysis.

For $x = 0$ we have

$$\lim_{x \rightarrow 0} \left(\frac{(x-4)\sin(x)}{x^3 - 8x^2 + 16x} \right) = \lim_{x \rightarrow 0} \left(\frac{\sin(x)}{x(x-4)} \right) = \lim_{x \rightarrow 0} \left(\frac{\sin(x)}{x} \cdot \frac{1}{x-4} \right) = 1 \cdot \frac{1}{0-4} = -\frac{1}{4}$$

Since this limit is not infinite, $x = 0$ is not a vertical asymptote.

For $x = 4$, we use the simplified form of f : $f(x) = \frac{\sin(x)}{x(x-4)}$. Direct substitution of $x = 4$ in the simplified form gives “nonzero number divided by 0”, whence $x = 4$ is a vertical

asymptote. Observe that $\pi < 4 < 2\pi$, which means that $\sin(4) < 0$. So now testing $x = 3.99$ and $x = 4.01$ for the left- and right-limits, respectively, we have the following.

$$\lim_{x \rightarrow 4^-} f(x) = \frac{\ominus}{(4)(0^-)} = +\infty \quad , \quad \lim_{x \rightarrow 4^+} f(x) = \frac{\ominus}{(4)(0^+)} = -\infty$$

- (d) Candidate vertical asymptotes occur at x -values not in the domain of f or at the boundary of the domain of f . Since the domain of f is $(0, \infty)$, the only candidate vertical asymptote is $x = 0$. Now recall the basic property of $\ln(x)$ that $\lim_{x \rightarrow 0^+} \ln(x) = -\infty$. (The left-sided limit makes no sense to consider since $\ln(x)$ is not defined for $x < 0$.) Hence $x = 0$ is a vertical asymptote.
- (e) Candidate vertical asymptotes occur at x -values where $1 - e^x = 0$. Hence the only candidate vertical asymptote is the line $x = 0$. Substitution of $x = 0$ gives “ $\frac{5}{0}$ ” (nonzero number divided by 0), whence $x = 0$ is a vertical asymptote. Now for the one-sided limits.

Note that if x is a small negative number (i.e., $x \rightarrow 0^-$), then e^x is slightly less than 1, and so $1 - e^x$ is slightly positive. Hence we have

$$\lim_{x \rightarrow 0^-} \left(\frac{2e^x + 3}{1 - e^x} \right) = \frac{5}{0^+} = +\infty$$

Similarly, if x is a small positive number (i.e., $x \rightarrow 0^+$), then e^x is slightly greater than 1, and so $1 - e^x$ is slightly negative. Hence we have

$$\lim_{x \rightarrow 0^+} \left(\frac{2e^x + 3}{1 - e^x} \right) = \frac{5}{0^-} = -\infty$$

- (f) The domain of $f(x)$ is all real numbers except $x = 0$ and f is continuous on its domain. So the only candidate vertical asymptote is $x = 0$. Note that f is not a fraction, so substitution of $x = 0$ alone does not yet determine whether $x = 0$ is a vertical asymptote. So we look at the one-sided limits.

First we note two basic one-sided limits.

$$\lim_{x \rightarrow 0^-} \left(\frac{-1}{x} \right) = \frac{-1}{0^-} = +\infty \quad , \quad \lim_{x \rightarrow 0^+} \left(\frac{-1}{x} \right) = \frac{-1}{0^+} = -\infty$$

Letting $u = -1/x$ and using the continuity of e^x , we have the following.

$$\begin{aligned} \lim_{x \rightarrow 0^-} e^{-1/x} &= \lim_{u \rightarrow \infty} e^u = \infty \\ \lim_{x \rightarrow 0^+} e^{-1/x} &= \lim_{u \rightarrow -\infty} e^u = 0 \end{aligned}$$

Hence the line $x = 0$ is a vertical asymptote. (Note that the limit is infinite only one side, but this is okay!)

§2.5: Limits at Infinity

*Difficulty guide for this worksheet:**Core or Beyond Core:* 34, 35 (all parts except e)*Advanced:* 35e*Removed from syllabus:* none**W34.** For each part, calculate the limit or show that it does not exist. Show all work.

- (a) $\lim_{x \rightarrow \infty} \left(\frac{3x - 5}{x + 1} \right)$
- (b) $\lim_{x \rightarrow -\infty} \left(\frac{3x}{\sqrt{4x^2 + 9}} \right)$
- (c) $\lim_{x \rightarrow \infty} \left(\frac{(x - 3)(2x + 4)(x - 5)}{(3x + 1)(4x - 7)(x + 2)} \right)$
- (d) $\lim_{x \rightarrow -\infty} \left(\frac{(x - 3)(2x + 4)(x - 5)}{(3x + 1)(4x - 7)(x + 2)} \right)$
- (e) $\lim_{x \rightarrow \infty} \cos \left(\frac{1}{x} \right)$
- (f) $\lim_{x \rightarrow \infty} e^{-x^3}$

Solution

(a) Factor out dominant terms.

$$\begin{aligned} \lim_{x \rightarrow \infty} \left(\frac{3x - 5}{x + 1} \right) &= \lim_{x \rightarrow \infty} \left(\frac{x}{x} \cdot \frac{3 - \frac{5}{x}}{1 + \frac{1}{x}} \right) = \lim_{x \rightarrow \infty} \left(\frac{x}{x} \right) \cdot \lim_{x \rightarrow \infty} \left(\frac{3 - \frac{5}{x}}{1 + \frac{1}{x}} \right) \\ &= 1 \cdot \frac{3 - 0}{1 + 0} = 3 \end{aligned}$$

(b) Factor out dominant terms. Remember that $\sqrt{x^2} = |x|$. If $x \rightarrow -\infty$, we may assume $x < 0$, so that $|x| = -x$.

$$\begin{aligned} \lim_{x \rightarrow -\infty} \left(\frac{3x}{\sqrt{4x^2 + 9}} \right) &= \lim_{x \rightarrow -\infty} \left(\frac{3x}{\sqrt{x^2} \left(4 + \frac{9}{x^2} \right)} \right) = \lim_{x \rightarrow -\infty} \left(\frac{x}{|x|} \cdot \frac{3}{\sqrt{4 + \frac{9}{x^2}}} \right) \\ &= \lim_{x \rightarrow -\infty} \left(\frac{x}{-x} \cdot \frac{3}{\sqrt{4 + \frac{9}{x^2}}} \right) \\ &= \lim_{x \rightarrow -\infty} \left(\frac{x}{-x} \right) \cdot \lim_{x \rightarrow -\infty} \left(\frac{3}{\sqrt{4 + \frac{9}{x^2}}} \right) \\ &= -1 \cdot \frac{3}{\sqrt{4 + 0}} = -\frac{3}{2} \end{aligned}$$

(c) Factor out dominant terms.

$$\begin{aligned} \lim_{x \rightarrow \infty} \left(\frac{(x - 3)(2x + 4)(x - 5)}{(3x + 1)(4x - 7)(x + 2)} \right) &= \lim_{x \rightarrow \infty} \left(\frac{x^3}{x^3} \cdot \frac{\left(1 - \frac{3}{x} \right) \left(2 + \frac{4}{x} \right) \left(1 - \frac{5}{x} \right)}{\left(3 + \frac{1}{x} \right) \left(4 - \frac{7}{x} \right) \left(1 + \frac{2}{x} \right)} \right) \\ &= 1 \cdot \frac{(1 - 0)(2 + 0)(1 - 0)}{(3 + 0)(4 - 0)(1 + 0)} = \frac{1}{6} \end{aligned}$$

- (d) Same work as part (d). Note that the sign of the infinity symbol is irrelevant in the solution since all of the reciprocals (terms like $\frac{1}{x}$) go to 0 whether $x \rightarrow \infty$ or $x \rightarrow -\infty$. So the limit is equal to $\frac{1}{6}$.
- (e) As $x \rightarrow \infty$, we have that $\frac{1}{x} \rightarrow 0$. Since the cosine function is continuous, we have

$$\lim_{x \rightarrow \infty} \cos\left(\frac{1}{x}\right) = \cos\left(\lim_{x \rightarrow \infty} \frac{1}{x}\right) = \cos(0) = 1$$

- (f) Note that $-x^3 \rightarrow -\infty$ as $x \rightarrow \infty$. So we have

$$\lim_{x \rightarrow \infty} e^{-x^3} = \lim_{u \rightarrow -\infty} e^u = 0$$

W35. For each function, find all horizontal asymptotes.

(a) $f(x) = \frac{(x-1)(2x+5)}{(x+1)(3x-6)}$

(c) $f(x) = \frac{2e^x + 3}{1 - e^x}$

(e) $f(x) = \frac{2x}{x - \sqrt{x^2 + 10}}$

(b) $f(x) = \ln(x)$

(d) $f(x) = e^{-1/x}$

Solution

- (a) To calculate the limits as $x \rightarrow \pm\infty$, we factor out dominant terms.

$$\begin{aligned} \lim_{x \rightarrow -\infty} \left(\frac{(x-1)(2x+5)}{(x+1)(3x-6)} \right) &= \lim_{x \rightarrow -\infty} \left(\frac{x^2}{x^2} \cdot \frac{(1 - \frac{1}{x})(2 + \frac{5}{x})}{(1 + \frac{1}{x})(3 - \frac{6}{x})} \right) \\ &= 1 \cdot \frac{(1-0)(2+0)}{(1+0)(3-0)} = \frac{2}{3} \end{aligned}$$

Note that the work would be identical if we had $x \rightarrow \infty$ (all the reciprocals would still approach 0). Hence we have

$$\lim_{x \rightarrow \infty} \left(\frac{(x-1)(2x+5)}{(x+1)(3x-6)} \right) = \frac{2}{3}$$

The only horizontal asymptote is the line $y = \frac{2}{3}$.

- (b) The domain of $\ln(x)$ is $(0, \infty)$, so it only makes sense to consider a horizontal asymptote of f as $x \rightarrow \infty$. Since $\ln(x) \rightarrow \infty$ as $x \rightarrow \infty$, we see that there are no horizontal asymptotes.
- (c) Recall that $e^x \rightarrow 0$ as $x \rightarrow -\infty$. So we have the following.

$$\lim_{x \rightarrow -\infty} \left(\frac{2e^x + 3}{1 - e^x} \right) = \frac{0 + 3}{1 - 0} = 3$$

Recall that $e^x \rightarrow \infty$ as $x \rightarrow \infty$. So we have the following.

$$\lim_{x \rightarrow \infty} f(x) = \lim_{x \rightarrow \infty} \left(\frac{e^x}{e^x} \cdot \frac{2 + 3e^{-x}}{e^{-x} - 1} \right) = \lim_{x \rightarrow \infty} \left(\frac{2 + 3e^{-x}}{e^{-x} - 1} \right) = \frac{2 + 0}{0 - 1} = -2$$

Hence the horizontal asymptotes are the lines $y = -2$ and $y = 3$.

(d) Note that $-1/x \rightarrow 0$ as $x \rightarrow \pm\infty$. Since e^x is continuous, we have:

$$\lim_{x \rightarrow \pm\infty} e^{-1/x} = e^{\lim_{x \rightarrow \pm\infty} (-1/x)} = e^0 = 1$$

Hence the line $y = 1$ is the only horizontal asymptote.

(e) Similar to question #1b above, we first algebraically manipulate f by factoring out highest powers of x . We also recall that $\sqrt{x^2} = |x|$. So we have:

$$f(x) = \frac{2x}{x - \sqrt{x^2 + 10}} = \frac{2x}{x - \sqrt{x^2 \left(1 + \frac{10}{x^2}\right)}} = \frac{2x}{x - |x|\sqrt{1 + \frac{10}{x^2}}} = \frac{2}{1 - \frac{|x|}{x}\sqrt{1 + \frac{10}{x^2}}}$$

Now we calculate the horizontal asymptotes. For the limit $x \rightarrow -\infty$, we may assume x is negative, whence $|x| = -x$ and $\frac{|x|}{x} = -1$, and so

$$f(x) = \frac{2}{1 + \sqrt{1 + \frac{10}{x^2}}}$$

So now computing the limit gives

$$\lim_{x \rightarrow -\infty} f(x) = \lim_{x \rightarrow -\infty} \left(\frac{2}{1 + \sqrt{1 + \frac{10}{x^2}}} \right) = \frac{2}{1 + \sqrt{1 + 0}} = \frac{2}{1 + 1} = 1$$

So the line $y = 1$ is a horizontal asymptote.

Now for the limit $x \rightarrow +\infty$, we may assume x is positive, whence $|x| = x$, and $\frac{|x|}{x} = 1$, and so

$$f(x) = \frac{2}{1 - \sqrt{1 + \frac{10}{x^2}}}$$

So now computing the limit gives

$$\lim_{x \rightarrow +\infty} f(x) = \lim_{x \rightarrow +\infty} \left(\frac{2}{1 - \sqrt{1 + \frac{10}{x^2}}} \right) = \frac{2}{1 - \sqrt{1 + 0}} = \frac{2}{1 - 1} = \frac{2}{0}$$

This is an undefined expression, but recall that a limit of the form “nonzero number divided by 0” indicates that the limit is infinite. So there is no other horizontal asymptote.

But as a bonus, what is the value of this last limit? The above limit must be either $+\infty$ or $-\infty$. Now observe that $1 + \frac{10}{x^2} > 1$, which implies that $\sqrt{1 + \frac{10}{x^2}} > 1$, and so

$$1 - \sqrt{1 + \frac{10}{x^2}} < 0$$

So as $x \rightarrow +\infty$, we see that $1 - \sqrt{1 + \frac{10}{x^2}}$ approaches 0 but remains negative. Hence we have

$$\lim_{x \rightarrow +\infty} f(x) = \lim_{x \rightarrow +\infty} \left(\frac{2}{1 - \sqrt{1 + \frac{10}{x^2}}} \right) = \frac{2}{0^-} = -\infty$$

§2.6: Continuity

*Difficulty guide for this worksheet:**Core or Beyond Core:* 36, 37, 38, 39, 40*Advanced:* 41*Removed from syllabus:* 42, 43**W36.** Determine all points where the following function is continuous.*Make sure you give a justification for any x -value at which you claim f is continuous.*

$$f(x) = \begin{cases} 3x^2 - x + 1 & , \quad x < -2 \\ 15 + \sin(2\pi x) & , \quad -2 \leq x < 3 \\ 2x - 4 & , \quad 3 \leq x \end{cases}$$

Solution

Each individual piece is continuous for all real numbers, so we only have to check continuous at the transition points $x = -2$ and $x = 3$. To guarantee continuity at a point, the left-limit, right-limit, and function value must all be equal at that point.

- ($x = -2$):

$$\lim_{x \rightarrow -2^-} f(x) = \lim_{x \rightarrow -2^-} (3x^2 - x + 1) = 3(-2)^2 - (-2) = 15$$

$$\lim_{x \rightarrow -2^+} f(x) = \lim_{x \rightarrow -2^+} (15 + \sin(2\pi x)) = 15 + \sin(-4\pi) = 15$$

$$f(-2) = (15 + \sin(2\pi x))|_{x=-2} = 15 + \sin(-4\pi) = 15$$

Hence f is continuous at $x = -2$.

- ($x = 3$):

$$\lim_{x \rightarrow 3^-} f(x) = \lim_{x \rightarrow 3^-} (15 + \sin(2\pi x)) = 15 + \sin(-6\pi) = 15$$

$$\lim_{x \rightarrow 3^+} f(x) = \lim_{x \rightarrow 3^+} (2x - 4) = 2(3) - 4 = 2$$

$$f(3) = (2x - 4)|_{x=3} = 2(3) - 4 = 2$$

Hence f is not continuous at $x = 3$.

The function f is continuous on $(-\infty, 3) \cup (3, \infty)$.

W37. Let $f(x) = \frac{x^3 - 9x}{x + 3}$.

- What is the domain of f ?
- Find all points where f is discontinuous.
- For each x -value you found in part (b), determine what value should be assigned to f , if any, to guarantee that f will be continuous there.

(For example, if you claim f is discontinuous at $x = a$, then you should determine the value that should be assigned to $f(a)$, if any, to guarantee that f will be continuous at $x = a$.)

Solution

- (a) $(-\infty, -3) \cup (-3, \infty)$.
- (b) Since f is a rational function, f is discontinuous only at points not in its domain. Hence f is discontinuous only at $x = -3$.
- (c) A function is continuous at a point if and only if its function value is equal to the limit value there. Hence the only possible choice for $f(-3)$ to make f continuous is

$$\begin{aligned} f(-3) &= \lim_{x \rightarrow -3} f(x) = \lim_{x \rightarrow -3} \left(\frac{x^3 - 9x}{x + 3} \right) = \lim_{x \rightarrow -3} \left(\frac{x(x-3)(x+3)}{x+3} \right) \\ &= \lim_{x \rightarrow -3} (x(x-3)) = (-3)(-3-3) = 18 \end{aligned}$$

Hence if f is to be continuous at $x = -3$, we must choose $f(-3) = 18$.

W38. Let $f(x) = \frac{\sqrt{2x^2 + 1} - 1}{x^2(x-3)}$.

- (a) What is the domain of f ?
- (b) Find all points where f is discontinuous.
- (c) For each x -value you found in part (b), determine what value should be assigned to f , if any, to guarantee that f will be continuous there.

(For example, if you claim f is discontinuous at $x = a$, then you should determine the value that should be assigned to $f(a)$, if any, to guarantee that f will be continuous at $x = a$.)

Solution

- (a) Note that $2x^2 + 1 \geq 0$ always, so the only points not in the domain of f are those for which $x^2(x-3) = 0$. Hence the domain is $(-\infty, 0) \cup (0, 3) \cup (3, \infty)$.
- (b) Since f is an algebraic function, f is discontinuous only at points not in its domain. Hence f is discontinuous only at $x = 0$ and $x = 3$.
- (c) A function is continuous at a point if and only if its function value is equal to the limit value there. Hence the only possible choice for $f(0)$ to make f continuous there is

$$\begin{aligned} f(0) &= \lim_{x \rightarrow 0} f(x) = \lim_{x \rightarrow 0} \left(\frac{\sqrt{2x^2 + 1} - 1}{x^2(x-3)} \right) \\ &= \lim_{x \rightarrow 0} \left(\frac{\sqrt{2x^2 + 1} - 1}{x^2(x-3)} \cdot \frac{\sqrt{2x^2 + 1} + 1}{\sqrt{2x^2 + 1} + 1} \right) = \lim_{x \rightarrow 0} \left(\frac{2x^2}{x^2(x-3)(\sqrt{2x^2 + 1} + 1)} \right) \\ &= \lim_{x \rightarrow 0} \left(\frac{2}{(x-3)(\sqrt{2x^2 + 1} + 1)} \right) = \frac{2}{(-3)(1+1)} = -\frac{1}{3} \end{aligned}$$

Hence if f is to be continuous at $x = 0$, we must choose $f(0) = -\frac{1}{3}$.

The only possible choice for $f(3)$ to make f continuous there is

$$f(3) = \lim_{x \rightarrow 3} f(x) = \lim_{x \rightarrow 3} \left(\frac{\sqrt{2x^2 + 1} - 1}{x^2(x-3)} \right)$$

Observe that substitution of $x = 3$ gives the undefined form $\frac{\sqrt{19}-1}{0}$, or a non-zero number divided by zero. This indicates that the left- and right-limits are both infinite. Hence the

overall limit is either infinite or does not exist. In any event, there is no value we may assign to $f(3)$ to make f continuous at $x = 3$.

W39. Find the values of the constants a and b that make f continuous for all real numbers.

$$f(x) = \begin{cases} ax^2 - x & , \quad x < 4 \\ 6 & , \quad x = 4 \\ x^3 + bx & , \quad x > 4 \end{cases}$$

Solution

Any values of a and b make each individual piece continuous for all real numbers. Hence we need only force continuity at $x = 4$.

$$\begin{aligned} \lim_{x \rightarrow 4^-} f(x) &= \lim_{x \rightarrow 4^-} (ax^2 - x) = 16a - 4 \\ \lim_{x \rightarrow 4^+} f(x) &= \lim_{x \rightarrow 4^+} (x^3 + bx) = 64 + 4b \\ f(4) &= 6 \end{aligned}$$

If f is to be continuous at $x = 4$, these three values must be equal. Hence we obtain the two equations $16a - 4 = 6$ (whence $a = \frac{10}{16}$) and $64 + 4b = 6$ (whence $b = -\frac{29}{2}$).

W40. For what values of a and b is the following function continuous for all x ?

$$g(x) = \begin{cases} ax + 2b & , \quad x \leq 0 \\ x^2 + 3a - b & , \quad 0 < x \leq 2 \\ 3x - 5 & , \quad x > 2 \end{cases}$$

Solution

Any values of a and b make each individual piece continuous for all real numbers. Hence we need only force continuity at $x = 0$ and $x = 2$. For $x = 0$, we have:

$$\begin{aligned} \lim_{x \rightarrow 0^-} f(x) &= \lim_{x \rightarrow 0^-} (ax + 2b) = 2b \\ \lim_{x \rightarrow 0^+} f(x) &= \lim_{x \rightarrow 0^+} (x^2 + 3a - b) = 3a - b \\ f(0) &= 2b \end{aligned}$$

Hence we must have $2b = 3a - b$ (equivalently, $a = b$) to have continuity at $x = 0$. For $x = 2$, we have:

$$\begin{aligned} \lim_{x \rightarrow 2^-} f(x) &= \lim_{x \rightarrow 2^-} (x^2 + 3a - b) = 4 + 3a - b \\ \lim_{x \rightarrow 2^+} f(x) &= \lim_{x \rightarrow 2^+} (3x - 5) = 1 \\ f(2) &= 4 + 3a - b \end{aligned}$$

Hence we must have $4 + 3a - b = 1$ to have continuity at $x = 2$. We already have that $a = b$, and so our condition for continuity at $x = 2$ becomes $4 + 2a = 1$, or $a = -3/2$. Hence for g to be continuous for all x , we must have $a = b = -3/2$.

W41. Find the values of the constants a and b that make f continuous at $x = 0$. You may assume $a > 0$.

$$f(x) = \begin{cases} \frac{1 - \cos(ax)}{x^2} & , \quad x < 0 \\ 2a + b & , \quad x = 0 \\ \frac{x^2 - bx}{\sin(x)} & , \quad x > 0 \end{cases}$$

Solution

We need only force continuity at $x = 0$.

$$\begin{aligned} \lim_{x \rightarrow 0^-} f(x) &= \lim_{x \rightarrow 0^-} \left(\frac{1 - \cos(ax)}{x^2} \right) = \lim_{x \rightarrow 0^-} \left(\frac{1 - \cos(ax)}{x^2} \cdot \frac{1 + \cos(ax)}{1 + \cos(ax)} \right) \\ &= \lim_{x \rightarrow 0^-} \left(\frac{1 - \cos(ax)^2}{x^2(1 + \cos(ax))} \right) = \lim_{x \rightarrow 0^-} \left(\frac{\sin(ax)^2}{x^2(1 + \cos(ax))} \right) \\ &= \lim_{x \rightarrow 0^-} \left(\left(\frac{\sin(ax)}{x} \right)^2 \cdot \frac{1}{1 + \cos(ax)} \right) \\ &= \lim_{x \rightarrow 0^-} \left(\left(a \cdot \frac{\sin(ax)}{ax} \right)^2 \cdot \frac{1}{1 + \cos(ax)} \right) = (a \cdot 1)^2 \cdot \frac{1}{1 + 1} = \frac{a^2}{2} \\ \lim_{x \rightarrow 0^+} f(x) &= \lim_{x \rightarrow 0^+} \left(\frac{x^2 - bx}{\sin(x)} \right) = \lim_{x \rightarrow 0^+} \left(\frac{x}{\sin(x)} \cdot (x - b) \right) = 1 \cdot (0 - b) = -b \\ f(0) &= 2a + b \end{aligned}$$

If f is to be continuous at $x = 0$, these three values must be equal. Hence we obtain the two equations $\frac{a^2}{2} = 2a + b$ and $-b = 2a + b$. Solving the second equation for b gives $b = -a$. Substituting $b = -a$ into the first equation gives $\frac{a^2}{2} = 2a - a = a$. Dividing by a (which we are told is positive!) gives $\frac{a}{2} = 1$, or $a = 2$. Hence we must choose $a = 2$ and $b = -2$.

W42. Prove that the equation $\sqrt{x} + x^3 = 1$ has a solution in the interval $[0, 1]$.

Solution

Let $f(x) = \sqrt{x} + x^3 - 1$. We need to show that there exists c in the interval $[0, 1]$ such that $f(c) = 0$. Observe that $f(0) = -1 < 0$ and $f(1) = 1 > 0$. Since f is continuous on $[0, 1]$ and 0 is between -1 and 1, it follows by the intermediate value theorem, that such a value of c exists.

W43. Prove that the equation $x^4 + 3x^2 + 2 = 4x^3 + 8x$ has a solution.

Solution

Let $f(x) = x^4 + 3x^2 + 2 - 4x^3 - 8x$. We need to show that there exists c such that $f(c) = 0$. Observe that $f(0) = 2 > 0$ and $f(1) = -6 < 0$. Since f is continuous on $[0, 1]$ and 0 is between -6 and 2, it follows by the intermediate value theorem, that there exists c in the interval $[0, 1]$ such that $f(c) = 0$.

2.3 Chapter 3: Derivatives

§3.1, 3.2: Introduction to the Derivative

Difficulty guide for this worksheet:

Core or Beyond Core: 44, 45 (all parts except f), 46

Advanced: 45f, 48

Removed from syllabus: 47

W44. Suppose the line described by $y = 5x - 9$ is tangent to the graph of $y = f(x)$ at $x = 4$.

- (a) Calculate $f(4)$. If there is not enough information to do so, explain why.
- (b) Calculate $f(3)$. If there is not enough information to do so, explain why.
- (c) Calculate $f'(4)$. If there is not enough information to do so, explain why.
- (d) Calculate $f'(3)$. If there is not enough information to do so, explain why.

Solution

- (a) The tangent line at $x = a$ is defined to be the line to pass through the point $(a, f(a))$ with slope $f'(a)$. The line $y = 5x - 9$ passes through $(4, 11)$ and is tangent to the graph of $y = f(x)$ at $x = 4$. Hence $f(4) = 11$.
- (b) The tangent line at $x = 4$ has no relation to the function $f(x)$ at any other value of x . So there is not enough information to tell the value of $f(3)$.
- (c) See solution for part (a). The slope of the line $y = 5x - 9$ is 5, whence $f'(4) = 5$.
- (d) See solution for part (b). There is not enough information to tell the value of $f'(3)$.

W45. Use the limit definition of the derivative to calculate the derivative of f at $x = 5$. Then find an equation for the line tangent to the graph of $y = f(x)$ at $x = 5$.

- | | |
|---|--|
| <ol style="list-style-type: none"> (a) $f(x) = 2x - 1$ (b) $f(x) = (2x - 1)^2$ (c) $f(x) = \sqrt{2x - 1}$ (d) $f(x) = \frac{1}{2x - 1}$ | <ol style="list-style-type: none"> (e) $f(x) = \frac{1}{\sqrt{2x - 1}}$ (f) $f(x) = \frac{1}{\sqrt{2x - 1}}$ |
|---|--|

Solution

- (a) Observe that $f(5) = 9$. Then, by definition, we have the following.

$$\begin{aligned} f'(5) &= \lim_{h \rightarrow 0} \left(\frac{f(5+h) - f(5)}{h} \right) = \lim_{h \rightarrow 0} \left(\frac{2(5+h) - 1 - 9}{h} \right) \\ &= \lim_{h \rightarrow 0} \left(\frac{2h}{h} \right) = \lim_{h \rightarrow 0} (2) = 2 \end{aligned}$$

Hence the tangent line has equation $y - 9 = 2(x - 5)$.

(b) Observe that $f(5) = 81$. Then, by definition, we have the following.

$$\begin{aligned} f'(5) &= \lim_{h \rightarrow 0} \left(\frac{f(5+h) - f(5)}{h} \right) = \lim_{h \rightarrow 0} \left(\frac{(2(5+h) - 1)^2 - 81}{h} \right) \\ &= \lim_{h \rightarrow 0} \left(\frac{(2h+9)^2 - 81}{h} \right) = \lim_{h \rightarrow 0} \left(\frac{4h^2 + 36h + 81 - 81}{h} \right) \\ &= \lim_{h \rightarrow 0} \left(\frac{4h^2 + 36h}{h} \right) = \lim_{h \rightarrow 0} (4h + 36) = 36 \end{aligned}$$

Hence the tangent line has equation $y - 81 = 36(x - 5)$.

(c) Observe that $f(5) = 3$. Then, by definition, we have the following.

$$\begin{aligned} f'(5) &= \lim_{h \rightarrow 0} \left(\frac{f(5+h) - f(5)}{h} \right) = \lim_{h \rightarrow 0} \left(\frac{\sqrt{2(5+h)} - 1 - 3}{h} \right) \\ &= \lim_{h \rightarrow 0} \left(\frac{\sqrt{2h+9} - 3}{h} \right) = \lim_{h \rightarrow 0} \left(\frac{2h+9-9}{h(\sqrt{2h+9}+3)} \right) \\ &= \lim_{h \rightarrow 0} \left(\frac{2}{\sqrt{2h+9}+3} \right) = \frac{2}{\sqrt{9}+3} = \frac{1}{3} \end{aligned}$$

Hence the tangent line has equation $y - 3 = \frac{1}{3}(x - 5)$.

(d) Observe that $f(5) = \frac{1}{9}$. Then, by definition, we have the following.

$$\begin{aligned} f'(5) &= \lim_{h \rightarrow 0} \left(\frac{f(5+h) - f(5)}{h} \right) = \lim_{h \rightarrow 0} \left(\frac{\frac{1}{2(5+h)-1} - \frac{1}{9}}{h} \right) \\ &= \lim_{h \rightarrow 0} \left(\frac{\frac{1}{2h+9} - \frac{1}{9}}{h} \right) = \lim_{h \rightarrow 0} \left(\frac{9 - (2h+9)}{9h(2h+9)} \right) \\ &= \lim_{h \rightarrow 0} \left(\frac{-2}{9(2h+9)} \right) = \frac{-2}{9(0+9)} = -\frac{2}{81} \end{aligned}$$

Hence the tangent line has equation $y - \frac{1}{9} = -\frac{2}{81}(x - 5)$.

(e) Observe that $f(5) = \frac{1}{3}$. Then, by definition, we have the following.

$$\begin{aligned} f'(5) &= \lim_{h \rightarrow 0} \left(\frac{f(5+h) - f(5)}{h} \right) = \lim_{h \rightarrow 0} \left(\frac{\frac{1}{\sqrt{2(5+h)}-1} - \frac{1}{3}}{h} \right) \\ &= \lim_{h \rightarrow 0} \left(\frac{\frac{1}{\sqrt{2h+9}} - \frac{1}{3}}{h} \right) = \lim_{h \rightarrow 0} \left(\frac{3 - \sqrt{2h+9}}{3h\sqrt{2h+9}} \right) \\ &= \lim_{h \rightarrow 0} \left(\frac{9 - (2h+9)}{3h\sqrt{2h+9}(3 + \sqrt{2h+9})} \right) \\ &= \lim_{h \rightarrow 0} \left(\frac{-2}{3\sqrt{2h+9}(3 + \sqrt{2h+9})} \right) = \frac{-2}{3\sqrt{9}(3 + \sqrt{9})} = -\frac{1}{27} \end{aligned}$$

Hence the tangent line has equation $y - \frac{1}{3} = -\frac{1}{27}(x - 5)$.

(f) Observe that $f(5) = \frac{1}{\sqrt{10-1}}$. Then, by definition, we have the following.

$$\begin{aligned}
 f'(5) &= \lim_{h \rightarrow 0} \left(\frac{f(5+h) - f(5)}{h} \right) = \lim_{h \rightarrow 0} \left(\frac{\frac{1}{\sqrt{2(5+h)-1}} - \frac{1}{\sqrt{10-1}}}{h} \right) \\
 &= \lim_{h \rightarrow 0} \left(\frac{\frac{1}{\sqrt{2h+10}-1} - \frac{1}{\sqrt{10-1}}}{h} \right) = \lim_{h \rightarrow 0} \left(\frac{\sqrt{10}-1 - (\sqrt{2h+10}-1)}{h(\sqrt{10}-1)(\sqrt{2h+10}-1)} \right) \\
 &= \lim_{h \rightarrow 0} \left(\frac{\sqrt{10} - \sqrt{2h+10}}{h(\sqrt{10}-1)(\sqrt{2h+10}-1)} \right) \\
 &= \lim_{h \rightarrow 0} \left(\frac{10 - (2h+10)}{h(\sqrt{10}-1)(\sqrt{2h+10}-1)(\sqrt{10} + \sqrt{2h+10})} \right) \\
 &= \lim_{h \rightarrow 0} \left(\frac{-2}{(\sqrt{10}-1)(\sqrt{2h+10}-1)(\sqrt{10} + \sqrt{2h+10})} \right) \\
 &= \frac{-2}{(\sqrt{10}-1)(\sqrt{10}-1)(\sqrt{10} + \sqrt{10+10})} = -\frac{1}{\sqrt{10}(\sqrt{10}-1)^2}
 \end{aligned}$$

Hence the tangent line has equation $y - \frac{1}{\sqrt{10-1}} = -\frac{1}{\sqrt{10}(\sqrt{10-1})^2}(x - 5)$.

W46. The graph of $y = f(x)$ is given below. Sketch a graph of $y = f'(x)$. Only the general shape is important. Do not worry about scales.

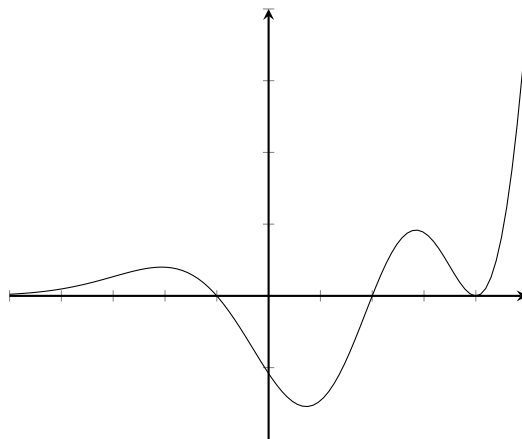

Solution

The graph of $y = f(x)$ is shown below in black. The graph of $y = f'(x)$ is shown below in blue.

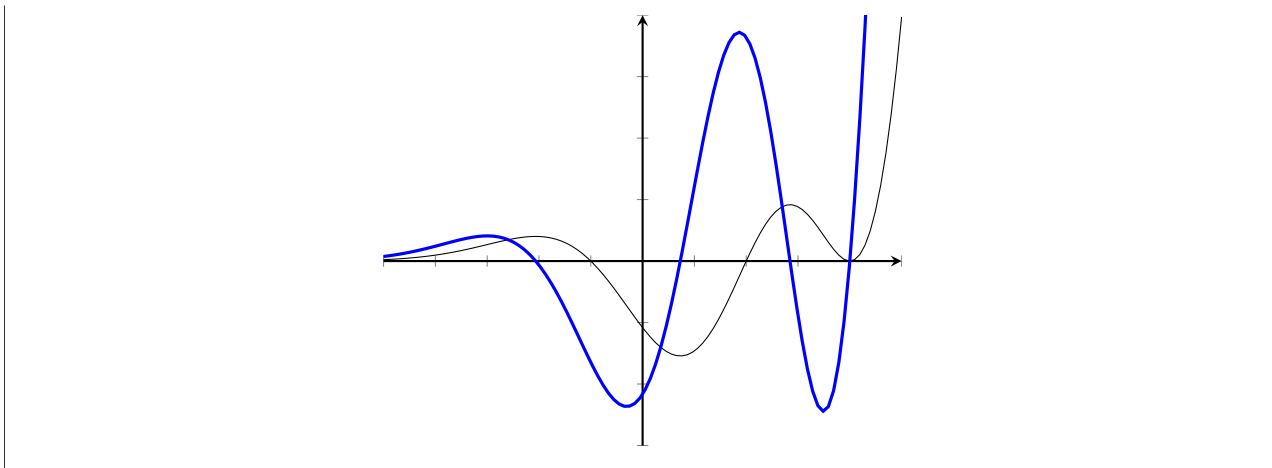

W47. Consider the following function.

$$f(x) = \begin{cases} -x^2 & , \quad x < 0 \\ x^2 + 2x & , \quad 0 \leq x < 1 \\ 6x - x^2 + c & , \quad x \geq 1 \end{cases}$$

- (a) Is f differentiable at $x = 0$?
 (b) Is there a value of c that makes f differentiable at $x = 1$? If so, calculate it. If not, explain why.

Solution

- (a) Observe that $f(0) = 0$. Then, by definition, we have the following.

$$f'(0) = \lim_{h \rightarrow 0} \left(\frac{f(0+h) - f(0)}{h} \right) = \lim_{h \rightarrow 0} \left(\frac{f(h)}{h} \right)$$

Since $f(h)$ is piecewise defined and changes definition at $h = 0$, we must compute the left- and right-limits.

$$\begin{aligned} \lim_{h \rightarrow 0^-} \left(\frac{f(h)}{h} \right) &= \lim_{h \rightarrow 0^-} \left(\frac{-h^2}{h} \right) = \lim_{h \rightarrow 0^-} (-h) = 0 \\ \lim_{h \rightarrow 0^+} \left(\frac{f(h)}{h} \right) &= \lim_{h \rightarrow 0^+} \left(\frac{h^2 + 2h}{h} \right) = \lim_{h \rightarrow 0^+} (h + 2) = 2 \end{aligned}$$

The one-sided limits are not equal, whence $f'(0)$ does not exist. That is, f is not differentiable at $x = 0$.

- (b) Recall that continuity is a necessary (but not sufficient) condition for differentiability. That is, if f is to be differentiable at $x = 1$, then f must also be continuous at $x = 1$. So first we determine the value of c that makes f continuous at $x = 1$.

$$\begin{aligned} \lim_{x \rightarrow 1^-} f(x) &= \lim_{x \rightarrow 1^-} (x^2 + 2x) = 1 + 2 = 3 \\ \lim_{x \rightarrow 1^+} f(x) &= \lim_{x \rightarrow 1^+} (6x - x^2 + c) = 6 - 1 + c = 5 + c \\ f(1) &= (6x - x^2 + c)|_{x=1} = 6 - 1 + c = 5 + c \end{aligned}$$

So we must have that $3 = 5 + c$, or $c = -2$.

Now we must check whether this value c makes f differentiable at $x = 1$. Observe that with $c = -2$, we have $f(1) = 3$. So, by definition, we have the following.

$$f'(1) = \lim_{h \rightarrow 0} \left(\frac{f(1+h) - f(1)}{h} \right) = \lim_{h \rightarrow 0} \left(\frac{f(1+h) - 3}{h} \right)$$

Since $f(1+h)$ is piecewise defined and changes definition at $h = 0$ (equivalently, at $x = 1$), we must compute the left- and right-limits.

$$\begin{aligned} \lim_{h \rightarrow 0^-} \left(\frac{f(1+h) - 3}{h} \right) &= \lim_{h \rightarrow 0^-} \left(\frac{(1+h)^2 + 2(1+h) - 3}{h} \right) \\ &= \lim_{h \rightarrow 0^-} \left(\frac{h^2 + 2h + 1 + 2 + 2h - 3}{h} \right) \\ &= \lim_{h \rightarrow 0^-} \left(\frac{h^2 + 4h}{h} \right) = \lim_{h \rightarrow 0^-} (h + 4) = 4 \\ \lim_{h \rightarrow 0^+} \left(\frac{f(1+h) - 3}{h} \right) &= \lim_{h \rightarrow 0^+} \left(\frac{6(1+h) - (1+h)^2 - 2 - 3}{h} \right) \\ &= \lim_{h \rightarrow 0^+} \left(\frac{6 + 6h - (1 + 2h + h^2) - 2 - 3}{h} \right) \\ &= \lim_{h \rightarrow 0^+} \left(\frac{4h - h^2}{h} \right) = \lim_{h \rightarrow 0^+} (4 - h) = 4 \end{aligned}$$

The one-sided limits are equal, whence $f'(1) = 4$. That is, the choice of $c = -2$ makes f differentiable at $x = 1$.

W48. Use the limit definition of derivative to find the derivative of $f(x) = x^{2/3}$.

Solution

By definition,

$$f'(a) = \lim_{h \rightarrow 0} \frac{f(a+h) - f(a)}{h} = \lim_{h \rightarrow 0} \frac{(a+h)^{2/3} - a^{2/3}}{h}$$

Note that we cannot expand binomials under fractional exponents. So we have to use a suitable change of variable to compute the limit. First change the variable from h to $u = (a+h)^{1/3}$ (which implies $h = u^3 - a$). Observe that if $h \rightarrow 0$, then $u \rightarrow a^{1/3}$. So we have

$$f'(a) = \lim_{u \rightarrow a^{1/3}} \frac{u^2 - a^{2/3}}{u^3 - a}$$

Now we just change the label of the constant a to make the algebra a bit clearer. Let $w = a^{1/3}$. Hence our limit can be written as

$$f'(a) = \lim_{u \rightarrow w} \frac{u^2 - w^2}{u^3 - w^3}$$

At this point this limit can be computed with the usual methods we have learned. Factor numerator and denominator, cancel common factors, and substitute $u = w^2$.

$$f'(a) = \lim_{u \rightarrow w} \frac{(u-w)(u+w)}{(u-w)(u^2+uw+w^2)} = \lim_{u \rightarrow w} \frac{u+w}{u^2+uw+w^2} = \frac{2w}{3w^2} = \frac{2}{3w} = \frac{2}{3a^{1/3}}$$

Hence we have shown that if $f(x) = x^{2/3}$, then $f'(x) = \frac{2}{3}x^{-1/3}$, as expected from the power rule.

§3.3, 3.4, 3.5, 3.9: Rules for Computing Derivatives

Difficulty guide for this worksheet:

Core or Beyond Core: 49, 50, 51, 52

Advanced: 53

Removed from syllabus: none

W49. Calculate $f'(x)$ for each function below. *After computing the derivative, do not simplify your answer.*

(a) $f(x) = \sqrt{2x} + 3x^2 + e^4$

(e) $f(x) = x^3 e^x$

(b) $f(x) = \frac{4}{x} + \ln(4)$

(f) $f(x) = \sqrt{x} \cos(x) - e^x \sin(x)$

(c) $f(x) = \frac{8x^4 - 5x^{1/3} + 1}{x^2}$

(g) $f(x) = \frac{\tan(x) + 9x^2}{\ln(x) - 4x}$

(d) $f(x) = \frac{x^2 + 3}{x - 1}$

(h) $f(x) = \frac{x \sin(x)}{1 - e^x \cos(x)}$

Solution

(a) First write $f(x)$ as

$$f(x) = \sqrt{2}x^{1/2} + 3x^2 + e^4$$

Now use power rule and the sum rule. (Remember that e^4 is just a constant!)

$$f'(x) = \sqrt{2} \cdot \frac{1}{2}x^{-1/2} + 3 \cdot 2x + 0$$

Simplifying coefficients gives

$$f'(x) = \frac{1}{\sqrt{2}x} + 6x$$

(b) First write $f(x)$ as

$$f(x) = 4x^{-1} + \ln(4)$$

Now use power rule and the sum rule. (Remember that $\ln(4)$ is just a constant!)

$$f'(x) = 4 \cdot (-1)x^{-2} + 0$$

Simplifying coefficients gives

$$f'(x) = -\frac{4}{x^2}$$

(c) First use algebra to simplify $f(x)$.

$$f(x) = 8x^2 - 5x^{-5/3} + x^{-2}$$

Now differentiate using power rule and sum rule.

$$f'(x) = 16x + \frac{25}{3}x^{-8/3} - 2x^{-3}$$

(d) Use quotient rule.

$$f'(x) = \frac{(x-1)(2x) - (x^2+3)(1)}{(x-1)^2}$$

(e) Use product rule.

$$f'(x) = x^3 e^x + 3x^2 e^x$$

(f) Use product rule on each term.

$$f'(x) = \left(x^{1/2}(-\sin(x)) + \frac{1}{2}x^{-1/2}\cos(x)\right) - (e^x \cos(x) + e^x \sin(x))$$

(g) Use quotient rule.

$$f'(x) = \frac{(\ln(x) - 4x)(\sec(x)^2 + 18x) - (\tan(x) + 9x^2)\left(\frac{1}{x} - 4\right)}{(\ln(x) - 4x)^2}$$

(h) Use quotient rule. When differentiating the numerator and denominator individually, use product rule.

$$f'(x) = \frac{(1 - e^x \cos(x))(x \cos(x) + \sin(x)) - (x \sin(x))(e^x \sin(x) - e^x \cos(x))}{(1 - e^x \cos(x))^2}$$

W50. Use the quotient rule to prove a derivative rule for $f(x) = \cot(x)$.

Solution

First write $f(x)$ as

$$f(x) = \frac{\cos(x)}{\sin(x)}$$

Now use quotient rule and simplify.

$$\begin{aligned} f'(x) &= \frac{\sin(x)(-\sin(x)) - \cos(x)\cos(x)}{\sin(x)^2} = \frac{-\sin(x)^2 - \cos(x)^2}{\sin(x)^2} \\ &= -\frac{\sin(x)^2 + \cos(x)^2}{\sin(x)^2} = -\frac{1}{\sin(x)^2} = -\csc(x)^2 \end{aligned}$$

We have thus proved the derivative rule

$$\frac{d}{dx}(\cot(x)) = -\csc(x)^2$$

W51. Find the x -coordinate of each point on the graph of the given function where the tangent line is horizontal.

(a) $f(x) = \frac{1}{x^2} - \frac{1}{x^3}$

(c) $f(x) = \frac{1}{\sqrt{x}}(x + 9)$

(b) $f(x) = (x^2 - 8)e^x$

(d) $f(x) = (1 - \sin(x))\sin(x)$

Solution

(a) Horizontal lines have zero slope and the derivative gives the slope of the tangent line at x . Hence we must solve the equation $f'(x) = 0$. First we write $f(x)$ as

$$f(x) = x^{-2} - x^{-3}$$

Now we compute the derivative using power rule.

$$f'(x) = -2x^{-3} + 3x^{-4}$$

Now we solve the equation $f'(x) = 0$.

$$\begin{aligned} 0 &= -2x^{-3} + 3x^{-4} \\ 0 \cdot x^4 &= (-2x^{-3} + 3x^{-4}) \cdot x^4 \\ 0 &= -2x + 3 \\ x &= \frac{3}{2} \end{aligned}$$

Hence the function $f(x)$ has a horizontal tangent line at $x = \frac{3}{2}$.

- (b) Horizontal lines have zero slope and the derivative gives the slope of the tangent line at x . Hence we must solve the equation $f'(x) = 0$. Now we compute the derivative using product rule and simplify.

$$f'(x) = (x^2 - 8)e^x + (2x)e^x = (x^2 + 2x - 8)e^x$$

Now we solve the equation $f'(x) = 0$. (Observe that $e^x \neq 0$ for all x , so we may cancel it from the equation.)

$$\begin{aligned} 0 &= (x^2 + 2x - 8)e^x \\ 0 &= x^2 + 2x - 8 \\ 0 &= (x + 4)(x - 2) \end{aligned}$$

Hence the function $f(x)$ has a horizontal tangent line at $x = -4$ and at $x = 2$.

- (c) Horizontal lines have zero slope and the derivative gives the slope of the tangent line at x . Hence we must solve the equation $f'(x) = 0$. First we write $f(x)$ as

$$f(x) = x^{1/2} + 9x^{-1/2}$$

Now we compute the derivative using power rule.

$$f'(x) = \frac{1}{2}x^{-1/2} - \frac{9}{2}x^{-3/2}$$

Now we solve the equation $f'(x) = 0$.

$$\begin{aligned} 0 &= \frac{1}{2}x^{-1/2} - \frac{9}{2}x^{-3/2} \\ 0 \cdot (2x^{3/2}) &= \left(\frac{1}{2}x^{-1/2} - \frac{9}{2}x^{-3/2} \right) \cdot (2x^{3/2}) \\ 0 &= x - 9 \\ x &= 9 \end{aligned}$$

Hence the function $f(x)$ has a horizontal tangent line at $x = 9$.

- (d) Horizontal lines have zero slope and the derivative gives the slope of the tangent line at x . Hence we must solve the equation $f'(x) = 0$. Now we compute the derivative using product rule and simplify.

$$f'(x) = (1 - \sin(x)) \cos(x) + -\cos(x) \sin(x) = \cos(x) - 2 \sin(x) \cos(x) = \cos(x)(1 - 2 \sin(x))$$

Now we solve the equation $f'(x) = 0$. Hence we have $\cos(x) = 0$ or $\sin(x) = 1/2$. The equation $\cos(x) = 0$ has two infinite sets of solutions: $x = \frac{\pi}{2} + 2\pi n$ (where n is any integer) or $x = \frac{3\pi}{2} + 2\pi n$ (where n is any integer). The equation $\sin(x) = 1/2$ also has two infinite sets of solutions: $x = \frac{\pi}{6} + 2\pi n$ (where n is any integer) or $x = \frac{5\pi}{6} + 2\pi n$ (where n is any integer). Hence the graph of $y = f(x)$ has a horizontal tangent line at any value of x in any of these four sets of solutions.

W52. Find equations for two tangent lines to the graph of $f(x) = \frac{3x+5}{x+1}$ that are perpendicular to the line $2x - y = 1$.

Solution

The line $2x - y = 1$ has slope 2, whence the slope of our desired tangent lines is $m = -\frac{1}{2}$. The slope of the tangent line at x is given by $f'(x)$. Hence we must first solve the equation $f'(x) = -\frac{1}{2}$ to find the x -values at which the desired tangent lines occur.

We compute $f'(x)$ using quotient rule and simplify.

$$f'(x) = \frac{(x+1)(3) - (3x+5)(1)}{(x+1)^2} = \frac{-2}{(x+1)^2}$$

Now we solve the equation $f'(x) = -\frac{1}{2}$.

$$\begin{aligned} -\frac{1}{2} &= -\frac{2}{(x+1)^2} \\ 4 &= (x+1)^2 \\ \pm 2 &= x+1 \\ \pm 2 - 1 &= x \end{aligned}$$

Hence the x -values at which the desired tangent lines occur are $x = -3$ and $x = 1$. The corresponding y -values are $y = f(-3) = 2$ and $y = f(1) = 4$. Hence the equations of the two tangent lines are

$$y - 2 = -\frac{1}{2}(x + 3) \quad , \quad y - 4 = -\frac{1}{2}(x - 1)$$

W53. Find all points P on the graph of $y = 4x^2$ with the property that the tangent line at P passes through the point $(2, 0)$.

Solution

Let $f(x) = 4x^2$. Denote the unknown point P by (a, b) . Since P lies on the graph of $y = f(x)$, we have $P = (a, f(a)) = (a, 4a^2)$. Now we find an equation of the tangent line at point P . (This equation will depend on a .) The slope of the tangent line is $f'(a)$. Calculating the derivative of $f(x) = 4x^2$ gives $f'(x) = 8x$. Hence $f'(a) = 8a$. The point-slope form of the equation of the tangent line is the following.

$$y - 4a^2 = 8a(x - a)$$

Now we impose the condition that this tangent line must pass through the point $(2, 0)$. That is, substituting $x = 2$ and $y = 0$ into the equation for the tangent line must give a true statement.

$$0 - 4a^2 = 8a(2 - a)$$

Now we solve this equation for a .

$$-4a^2 = 8a(2 - a)$$

$$-4a^2 = 16a - 8a^2$$

$$4a^2 - 16a = 0$$

$$4a(a - 4) = 0$$

The solutions are $a = 0$ and $a = 4$. Thus the corresponding points for which the tangent line passes through the point $(2, 0)$ are $P_1 = (0, 0)$ and $P_2 = (4, 64)$. (Note that the corresponding tangent lines are $y = 0$ and $y = 32x - 64$.)

§3.7: The Chain Rule

*Difficulty guide for this worksheet:**Core or Beyond Core:* 54, 55 (all parts except d), 56*Advanced:* 55d, 57*Removed from syllabus:* none**W54.** Calculate $f'(x)$ for each function below. *After computing the derivative, do not simplify your answer.*

(a) $f(x) = \sqrt{\sin(x)}$

(b) $f(x) = \sin(\sqrt{x})$

(c) $f(x) = \sqrt{\sin(\sqrt{x})}$

(d) $f(x) = (x^3 - 3x + 2)^2$

(e) $f(x) = \frac{1}{(3x+1)^2}$

(f) $f(x) = (2x + \sec(x))^2$

(g) $f(x) = e^{-2x} \sin(x)$

(h) $f(x) = \frac{\ln(2x+1)}{(2x+1)^2}$

(i) $f(x) = (\tan(x) + 1)^4 \cos(2x)$

(j) $f(x) = \left(\frac{6}{9-2x}\right)^8$

(k) $f(x) = (\sin((4x-5)^2))^4$

(Many authors will write this function as $f(x) = \sin^4(4x-5)^2$, despite the ambiguous and inconsistent notation.)

(l) $f(x) = \sqrt[3]{\sin(x) \cos(x)}$

(m) $f(x) = \sqrt{\frac{x^2-1}{x^3+x}}$

(n) $f(x) = \ln(\ln(x))$

(o) $f(x) = \sin(\sin(\sin(x)))$

(p) $f(x) = (x + (x + \sin(x)^2)^3)^4$

(q) $f(x) = |x|$

*(Hint: use the identity $|x| = \sqrt{x^2}$.)***Solution**

(a) $f'(x) = \frac{1}{2} (\sin(x))^{-1/2} \cos(x)$

(b) $f'(x) = \cos(\sqrt{x}) \cdot \frac{1}{2} x^{-1/2}$

(c) $f'(x) = \frac{1}{2} (\sin(\sqrt{x}))^{-1/2} \cos(\sqrt{x}) \cdot \frac{1}{2} x^{-1/2}$

(d) $f'(x) = 2(x^3 - 3x + 2)(3x^2 - 3)$

(e) $f'(x) = -2(3x+1)^{-3} \cdot 3$

(f) $f'(x) = 2(2x + \sec(x))(2 + \sec(x) \tan(x))$

(g) $f'(x) = e^{-2x} \cos(x) - 2e^{-2x} \sin(x)$

(h) $f'(x) = \frac{(2x+1)^2 \cdot \frac{1}{2x+1} \cdot 2 - \ln(2x+1) \cdot 2(2x+1) \cdot 2}{(2x+1)^4}$

(i) $f'(x) = (\tan(x) + 1)^4 (-\sin(2x)) \cdot 2 + \cos(2x) \cdot 4(\tan(x) + 1)^3 \cdot \sec(x)^2$

(j) $f'(x) = 6^8 \cdot (-8) \cdot (9-2x)^{-9} \cdot (-2)$

(k) $f'(x) = 4(\sin((4x-5)^2))^3 \cdot \cos((4x-5)^2) \cdot 2(4x-5) \cdot 4$

(l) $f'(x) = \frac{1}{3} (\sin(x) \cos(x))^{-2/3} \cdot (\sin(x)(-\sin(x)) + \cos(x) \cos(x))$

(m) $f'(x) = \frac{1}{2} \left(\frac{x^2-1}{x^3+x}\right)^{-1/2} \cdot \frac{(x^3+x)(2x) - (x^2-1)(3x^2+1)}{(x^3+x)^2}$

$$(n) f'(x) = \frac{1}{\ln(x)} \cdot \frac{1}{x}$$

$$(o) f'(x) = \cos(\sin(\sin(x))) \cos(\sin(x)) \cos(x)$$

$$(p) f'(x) = 4 \left(x + (x + \sin(x)^2)^3 \right)^3 \cdot \left(1 + 3(x + \sin(x)^2)^2 \cdot (1 + 2 \sin(x) \cos(x)) \right)$$

$$(q) f'(x) = \frac{1}{2}(x^2)^{-1/2} \cdot (2x) = \frac{x}{|x|}$$

W55. Find the x -coordinate of each point at which the graph of $y = f(x)$ has a horizontal tangent line.

$$(a) f(x) = (2x^2 - 7)^3$$

$$(c) f(x) = \ln(3x^4 + 6x^2 - 4x^3 - 12x + 6)$$

$$(b) f(x) = x^2 e^{1-3x}$$

$$(d) f(x) = \frac{(e^{3x} + e^{-3x})^2}{e^{3x}}$$

Solution

- (a) Horizontal lines have slope 0 and the slope of the tangent line is given by the derivative. Hence we must solve the equation $f'(x) = 0$. Computing the derivative requires chain rule.

$$\begin{aligned} f'(x) &= 3(2x^2 - 7)^2 \cdot (4x) \\ 0 &= 12x(2x^2 - 7)^2 \end{aligned}$$

Hence either $12x = 0$ (whence $x = 0$) or $2x^2 - 7 = 0$ (whence $x = -\sqrt{\frac{7}{2}}$ or $x = \sqrt{\frac{7}{2}}$).

- (b) Horizontal lines have slope 0 and the slope of the tangent line is given by the derivative. Hence we must solve the equation $f'(x) = 0$. Computing the derivative requires chain rule and product rule.

$$\begin{aligned} f'(x) &= x^2 e^{1-3x} \cdot (-3) + 2x \cdot e^{1-3x} \\ 0 &= e^{1-3x}(-3x^2 + 2x) \\ 0 &= -3x^2 + 2x = x(-3x + 2) \end{aligned}$$

Hence either $x = 0$ or $-3x + 2 = 0$ (whence $x = \frac{2}{3}$).

- (c) Horizontal lines have slope 0 and the slope of the tangent line is given by the derivative. Hence we must solve the equation $f'(x) = 0$. Computing the derivative requires chain rule.

$$\begin{aligned} f'(x) &= \frac{1}{3x^4 + 6x^2 - 4x^3 - 12x + 6} \cdot (12x^3 + 12x - 12x^2 - 12) \\ 0 &= \frac{12x^3 + 12x - 12x^2 - 12}{3x^4 + 6x^2 - 4x^3 - 12x + 6} \\ 0 &= 12x^3 + 12x - 12x^2 - 12 \\ 0 &= x^3 + x - x^2 - 1 \\ 0 &= x(x^2 + 1) - (x^2 + 1) = (x - 1)(x^2 + 1) \end{aligned}$$

Hence either $x - 1 = 0$ (whence $x = 1$). (The equation $x^2 + 1 = 0$ has no solutions.) However, we see that $x = 1$ is not in the domain of f , since the argument of a logarithm must be a strictly positive number. (Attempting to substitute $x = 1$ into $f(x)$ gives the expression $\ln(-1)$.) So there are no points where the tangent line is horizontal.

- (d) Horizontal lines have slope 0 and the slope of the tangent line is given by the derivative. Hence we must solve the equation $f'(x) = 0$. Before computing the derivative, we will

simplify the function a bit. Combining all terms under one squaring operation gives the following.

$$f(x) = \frac{(e^{3x} + e^{-3x})^2}{e^{3x}} = \frac{(e^{3x} + e^{-3x})^2}{(e^{3x/2})^2} = \left(\frac{e^{3x} + e^{-3x}}{e^{3x/2}} \right)^2 = (e^{3x/2} + e^{-9x/2})^2$$

Computing the derivative now requires just chain rule.

$$f'(x) = 2(e^{3x/2} + e^{-9x/2}) \cdot \left(\frac{3}{2}e^{3x/2} - \frac{9}{2}e^{-9x/2} \right)$$

Now we solve $f'(x) = 0$, which gives us two equations to solve. The first equation, $e^{3x/2} + e^{-9x/2} = 0$, has no solution since e^z is always positive for any z , and so the left-hand side of the equation is the sum of two positive terms (and hence can't equal 0). The second equation we get from $f'(x) = 0$ is the following.

$$\begin{aligned} 0 &= \frac{3}{2}e^{3x/2} - \frac{9}{2}e^{-9x/2} \\ 0 &= e^{3x/2} - 3e^{-9x/2} \\ 3e^{-9x/2} &= e^{3x/2} \\ 3 &= e^{6x} \\ \ln(3) &= 6x \\ \frac{1}{6}\ln(3) &= x \end{aligned}$$

Hence the only horizontal tangent line occurs at $x = \frac{1}{6}\ln(3)$.

W56. It is estimated that t years from now, the population (in thousands of people) of a certain suburban community is modeled by the formula

$$p(t) = 20 - \frac{6}{t+1}$$

A separate environmental study indicates that the average daily level of carbon monoxide in the air (measured in ppm) will be

$$L(p) = 0.5\sqrt{p^2 + p + 58}$$

when the population is p thousand. Find the rate at which the level of carbon monoxide will be changing with respect to time two years from now. (*Make sure to indicate units in your answer.*)

Solution

Note that L is really a composition of functions. That is, $L = L(p(t))$. Hence the chain rule gives us the following.

$$\frac{dL}{dt} = L'(p(t)) \cdot p'(t)$$

We are interested in the value of $\frac{dL}{dt}$ when $t = 2$. Substituting $t = 2$ thus gives us

$$\left. \frac{dL}{dt} \right|_{t=2} = L'(p(2)) \cdot p'(2) = L'(18) \cdot p'(2)$$

(We have used the fact that $p(2) = 18$.) Now we compute derivatives.

$$L'(p) = 0.5 \cdot \frac{1}{2} (p^2 + p + 58)^{-1/2} \cdot (2p + 1) = \frac{2p + 1}{4\sqrt{p^2 + p + 58}}$$

$$p'(t) = -6(-1)(t + 1)^{-2} \cdot (1) = \frac{6}{(t + 1)^2}$$

For both derivatives, we have used chain rule. Hence we have $L'(18) = \frac{37}{80}$ and $p'(2) = \frac{2}{3}$. The desired rate (rate at which L is changing with respect to t) is then

$$\left. \frac{dL}{dt} \right|_{t=2} = \frac{37}{80} \cdot \frac{2}{3} = \frac{37}{120}$$

(The units of this rate are ppm per thousand people.)

W57. Suppose g and h are differentiable functions. Selected values of g , h , and their derivatives are given below.

x	$g(x)$	$g'(x)$	$h(x)$	$h'(x)$
2	1	7	2	3
4	-3	-9	1	5
16	5	-1	1	-6

Define the function f by the formula

$$f(x) = g(\sqrt{x})h(x^2)$$

- (a) Calculate $f(4)$ or explain why there is not enough information to do so.
 (b) Calculate $f'(4)$ or explain why there is not enough information to do so.

Solution

(a) $f(4) = g(\sqrt{4})h(4^2) = g(2)h(16) = 1 \cdot 1 = 1$

(b) First we calculate $f'(x)$ using product rule and chain rule (twice!).

$$f'(x) = g(\sqrt{x})h'(x^2) \cdot 2x + h(x^2)g'(\sqrt{x}) \cdot \frac{1}{2}x^{-1/2}$$

$$f'(x) = 2xg(\sqrt{x})h'(x^2) + \frac{g'(\sqrt{x})h(x^2)}{2\sqrt{x}}$$

Now we substitute $x = 4$ and use the table values.

$$f'(4) = 8g(2)h'(16) + \frac{g'(2)h(16)}{4} = 8 \cdot 1 \cdot (-6) + \frac{7 \cdot 1}{4} = -\frac{185}{4}$$

§3.8: Implicit Differentiation

Difficulty guide for this worksheet:

Core or Beyond Core: 58, 60, 61

Advanced: 59, 62

Removed from syllabus: none

W58. For each of the following parts, calculate $\frac{dy}{dx}$.

If y is given as an explicit function of x , then the derivative must also be an explicit function of x .

(a) $x^2 + y^3 = 12$

(e) $y = x^{\ln(\sqrt{x})}$

(b) $y + \frac{1}{xy} = x^2$

(f) $\sin(x + y) = x + \cos(y)$

(c) $y = \frac{\sqrt[18]{(x^{10} + 1)^3 (x^7 - 3)^8}}{e^{3x^2}}$

(g) $\ln\left(\frac{x - y}{xy}\right) = \frac{1}{y}$

(d) $y = \frac{e^{3x^2}}{(x^3 + 1)^2 (4x - 7)^{-2}}$

(h) $6x^2 + 3xy + 2y^2 + 17y = 6$

Solution

Throughout the solution, y' will denote $\frac{dy}{dx}$.

(a) Differentiating both sides with respect to x gives

$$2x + 3y^2 \cdot y' = 0$$

Solving for y' gives

$$y' = -\frac{2x}{3y^2}$$

(b) First write $\frac{1}{xy} = x^{-1}y^{-1}$. Differentiating both sides with respect to x gives

$$y' + x^{-1} \cdot (-1)y^{-2}y' + y^{-1} \cdot (-1)x^{-2} = 2x$$

Solving for y' gives

$$y' = \frac{2x + x^{-2}y^{-1}}{1 - x^{-1}y^{-2}}$$

(c) We use logarithmic differentiation. Start by taking logarithms of both sides of the equation and simplifying.

$$\begin{aligned} \ln(y) &= \ln\left(\frac{\sqrt[18]{(x^{10} + 1)^3 (x^7 - 3)^8}}{e^{3x^2}}\right) \\ &= \ln\left((x^{10} + 1)^{1/6} (x^7 - 3)^{4/9}\right) \\ &= \frac{1}{6} \ln(x^{10} + 1) + \frac{4}{9} \ln(x^7 - 3) \end{aligned}$$

Differentiating both sides with respect to x gives

$$\frac{1}{y} \cdot y' = \frac{1}{6} \cdot \frac{10x^9}{x^{10} + 1} + \frac{4}{9} \cdot \frac{7x^6}{x^7 - 3}$$

Solving for y' gives

$$y' = y \left(\frac{1}{6} \cdot \frac{10x^9}{x^{10} + 1} + \frac{4}{9} \cdot \frac{7x^6}{x^7 - 3} \right)$$

Replacing y with its explicit definition in terms of x gives

$$y' = \sqrt[18]{(x^{10} + 1)^3 (x^7 - 3)^8} \left(\frac{1}{6} \cdot \frac{10x^9}{x^{10} + 1} + \frac{4}{9} \cdot \frac{7x^6}{x^7 - 3} \right)$$

- (d) We use logarithmic differentiation. Start by taking logarithms of both sides of the equation and simplifying.

$$\begin{aligned} \ln(y) &= \ln \left(\frac{e^{3x^2}}{(x^3 + 1)^2 (4x - 7)^{-2}} \right) \\ &= \ln(e^{3x^2}) - \ln((x^3 + 1)^2) - \ln((4x - 7)^{-2}) \\ &= 3x^2 - 2 \ln(x^3 + 1) + 2 \ln(4x - 7) \end{aligned}$$

Differentiating both sides with respect to x gives

$$\frac{1}{y} \cdot y' = 6x - 2 \cdot \frac{3x^2}{x^3 + 1} + 2 \cdot \frac{4}{4x - 7}$$

Solving for y' gives

$$y' = y \left(6x - 2 \cdot \frac{3x^2}{x^3 + 1} + 2 \cdot \frac{4}{4x - 7} \right)$$

Replacing y with its explicit definition in terms of x gives

$$y' = \frac{e^{3x^2}}{(x^3 + 1)^2 (4x - 7)^{-2}} \left(6x - 2 \cdot \frac{3x^2}{x^3 + 1} + 2 \cdot \frac{4}{4x - 7} \right)$$

- (e) We use logarithmic differentiation. Start by taking logarithms of both sides of the equation and simplifying.

$$\begin{aligned} \ln(y) &= \ln \left(x^{\ln(\sqrt{x})} \right) \\ &= \ln(\sqrt{x}) \ln(x) \\ &= \frac{1}{2} \ln(x) \ln(x) \\ &= \frac{1}{2} (\ln(x))^2 \end{aligned}$$

Differentiating both sides with respect to x gives

$$\frac{1}{y} \cdot y' = \frac{1}{2} \cdot 2 \ln(x) \cdot \frac{1}{x} = \frac{\ln(x)}{x}$$

Solving for y' gives

$$y' = y \left(\frac{\ln(x)}{x} \right)$$

Replacing y with its explicit definition in terms of x gives

$$y' = x^{\ln(\sqrt{x})} \left(\frac{\ln(x)}{x} \right)$$

(f) Differentiating both sides with respect to x gives

$$\cos(x + y) \cdot (1 + y') = 1 - \sin(y)y'$$

Solving for y' gives

$$y' = \frac{1 - \cos(x + y)}{\cos(x + y) + \sin(y)}$$

(g) First simplify the left side of the equation to make the differentiation easier.

$$\ln(x - y) - \ln(x) - \ln(y) = y^{-1}$$

Differentiating both sides of this equation with respect to x gives

$$\frac{1}{x - y} \cdot (1 - y') - \frac{1}{x} - \frac{1}{y} \cdot y' = -y^{-2}y'$$

Now rewrite the equation with negative exponents to make solving for y' easier.

$$(x - y)^{-1}(1 - y') - x^{-1} - y^{-1}y' = -y^{-2}y'$$

Solving for y' gives

$$y' = \frac{(x - y)^{-1} - x^{-1}}{-y^{-2} + (x - y)^{-1} + y^{-1}}$$

(h) Differentiating both sides with respect to x gives

$$12x + 3xy' + 3y + 4yy' + 17y' = 0$$

Solving for y' gives

$$y' = \frac{-12x - 3y}{3x + 4y + 17}$$

W59. Suppose $x^2 + y^2 = R^2$, where R is a constant. Find y'' and fully simplify your answer as much as possible.

Solution

Differentiating both sides with respect to x gives

$$2x + 2y \cdot y' = 0$$

Solving for y' gives

$$y' = -\frac{x}{y}$$

Differentiating with respect to x once more gives

$$y'' = -\frac{y - xy'}{y^2}$$

Now substitute $y' = -\frac{x}{y}$ and simplify.

$$y'' = -\frac{y - x\left(-\frac{x}{y}\right)}{y^2} = -\frac{y^2 + x^2}{y^3} = -\frac{R^2}{y^3}$$

W60. Find an equation of the line tangent to the graph of

$$xe^y = 2xy + y^3$$

at the point $\left(\frac{1}{e-2}, 1\right)$.

Solution

Differentiating both sides with respect to x gives

$$xe^y \cdot y' + e^y = 2xy' + 2y + 3y^2 \cdot y'$$

Now substitute $x = \frac{1}{e-2}$ and $y = 1$.

$$\frac{e}{e-2} \cdot y' + e = \frac{2}{e-2} \cdot y' + 2 + 3y'$$

Solving for y' gives

$$y' = \frac{e-2}{2}$$

The desired tangent line has slope $\frac{e-2}{2}$ and passes through the point $\left(\frac{1}{e-2}, 1\right)$. Hence the tangent line is given by

$$y - 1 = \frac{e-2}{2} \left(x - \frac{1}{e-2}\right)$$

W61. Find an equation of the line tangent to the graph of

$$\sin(x - y) = xy$$

at the point $(0, \pi)$.

Solution

Differentiating both sides with respect to x gives

$$\cos(x - y) \cdot (1 - y') = xy' + y$$

Now substitute $x = 0$ and $y = \pi$.

$$(-1)(1 - y') = \pi$$

Solving for y' gives

$$y' = \pi + 1$$

The desired tangent line has slope $\pi + 1$ and passes through the point $(0, \pi)$. Hence the tangent line is given by

$$y - \pi = (\pi + 1)(x - 0)$$

W62. Suppose x and y satisfy the following equation.

$$x^2 + xy + 3y^2 = 99$$

- Find all points on the graph where the tangent line is horizontal.
- Find all points on the graph where the tangent line is vertical.

Solution

For both parts of the question, we need y' . So first differentiate both sides with respect to x .

$$2x + xy' + y + 6yy' = 0$$

Solving for y' gives

$$y' = -\frac{2x + y}{x + 6y}$$

- (a) The tangent line is horizontal where $y' = 0$. This means the numerator of y' must be equal to 0 and the denominator must be not equal to 0. Setting the numerator of y' equal to 0 gives the equation $2x + y = 0$, or $y = -2x$. Hence any point on the graph where the tangent line is horizontal must satisfy both the equation $x^2 + xy + 3y^2 = 99$ and $y = -2x$. Substitution of the latter into the former gives

$$99 = x^2 + x(-2x) + 3(-2x)^2 = 11x^2$$

Solving for x gives $x = \pm 3$. Hence there are two points on the graph where the tangent line is horizontal.

$$P_1 = (-3, 6)$$

$$P_2 = (3, -6)$$

We may then verify that neither of these points causes the denominator of y' to be equal to 0.

- (b) The tangent line is vertical where y' is infinite. This means the denominator of y' must be equal to 0 and the numerator must be not equal to 0. Setting the denominator of y' equal to 0 gives the equation $x + 6y = 0$, or $x = -6y$. Hence any point on the graph where the tangent line is vertical must satisfy both the equation $x^2 + xy + 3y^2 = 99$ and $x = -6y$. Substitution of the latter into the former gives

$$99 = (-6y)^2 + (-6y)y + 3y^2 = 33y^2$$

Solving for y gives $y = \pm\sqrt{3}$. Hence there are two points on the graph where the tangent line is horizontal.

$$P_1 = (6\sqrt{3}, -\sqrt{3})$$

$$P_2 = (-6\sqrt{3}, \sqrt{3})$$

We may then verify that neither of these points causes the numerator of y' to be equal to 0.

§3.11: Related Rates

*Difficulty guide for this worksheet:**Core or Beyond Core:* 63, 64, 65, 67, 68, 69, 70*Advanced:* 66, 68*Removed from syllabus:* none

- W63.** A rock is dropped into a lake and an expanding circular ripple results. When the radius of the ripple is 8 inches, the radius is increasing at a rate of 3 inches per second. At what rate is the area enclosed by the ripple changing at this time?

Solution

Let r be the radius of the ripple. At any time, the area A enclosed by the ripple is given by

$$A = \pi r^2$$

Differentiating with respect to time gives us the following equation, which also holds for all time.

$$\frac{dA}{dt} = 2\pi r \frac{dr}{dt}$$

We now substitute the information relevant to the desired specific time. We substitute $r = 8$ and $\frac{dr}{dt} = 3$ into both equations.

$$A = 64\pi$$

$$\frac{dA}{dt} = 48\pi$$

Hence the area is increasing at a rate of 48π in²/s.

- W64.** An environmental study of a certain community indicates that there will be

$$Q(p) = 2p^2 + 6p + 1$$

units of a harmful pollutant in the air when the population is p thousand. The population is currently 30,000 and is increasing at a rate of 2,000 per year. At what rate is the level of the air pollution increasing currently?

Solution

Differentiating our equation relating Q and p with respect to time gives

$$\frac{dQ}{dt} = (4p + 6) \frac{dp}{dt}$$

We now substitute the information relevant to the desired specific time. We substitute $p = 30$ and $\frac{dp}{dt} = 2$ into both equations.

$$Q = 2(30)^2 + 6(30) + 1 = 1981$$

$$\frac{dQ}{dt} = (4 \cdot 30 + 6) \cdot 2 = 252$$

Hence the pollutant is increasing at a rate of 252 units per year.

- W65.** Every day, a flight to Los Angeles flies directly over a man's home at a constant altitude of 4 miles. If we assume that the plane is flying at a constant speed of 400 miles per hour, at what rate is the angle of elevation of the man's line of sight changing with respect to time when the horizontal distance between the approaching plane and the man's location is exactly 3 miles?

Solution

Let x be the horizontal distance from the man to the airplane. Let θ be the angle of elevation. Since the height of the airplane is 4 miles, x and θ satisfy the equation

$$\tan(\theta) = \frac{4}{x}$$

See the figure below. (Note that the diagram on the right shows a specific time. The diagram on the left shows a general time.)

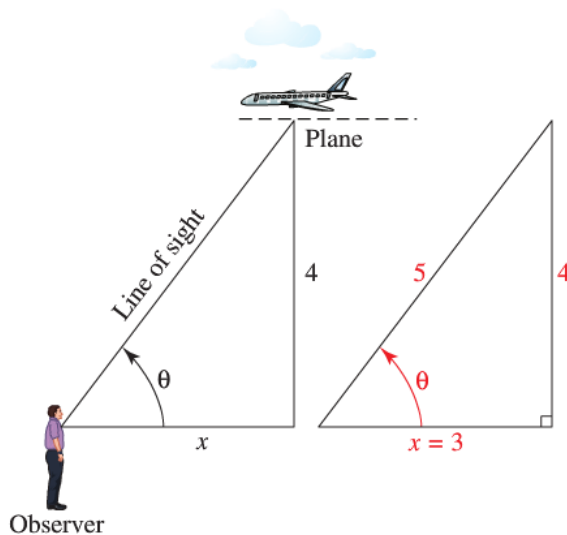

Differentiating with respect to time gives

$$\sec(\theta)^2 \frac{d\theta}{dt} = -\frac{4}{x^2} \frac{dx}{dt}$$

Now we substitute the information relevant to the desired specific time. We substitute $\frac{dx}{dt} = -400$ (negative because the distance x is decreasing since the plane is approaching the man) and $x = 3$.

$$\begin{aligned} \tan(\theta) &= \frac{4}{3} \\ \sec(\theta)^2 \frac{d\theta}{dt} &= \frac{1600}{9} \end{aligned}$$

We want an exact answer, so we use the identity $\sec(\theta)^2 = \tan(\theta)^2 + 1$. Given $\tan(\theta) = \frac{4}{3}$, we obtain $\sec(\theta)^2 = \frac{25}{9}$. Hence our second equation above becomes

$$\frac{25}{9} \frac{d\theta}{dt} = \frac{1600}{9}$$

Solving for $\frac{d\theta}{dt}$ gives

$$\frac{d\theta}{dt} = \frac{1600}{25} = 64$$

Hence the angle of elevation is increasing at a rate of 64 radians per hour.

- W66.** A person 6 feet tall stands 10 feet from point P , which is directly beneath a lantern hanging 30 feet above the ground. The lantern starts to fall, thus causing the person's shadow to lengthen. Given that the lantern falls $16t^2$ feet after t seconds, how fast will the shadow be lengthening exactly 1 second after the lantern has started to fall?

Solution

Let L be the length of the man's shadow and let s be the vertical distance from the lantern to the ground (point P). Using similar triangles, we see that L and s satisfy the equation

$$\frac{s}{6} = \frac{L + 10}{L}$$

(The distances 6 and 10 are constant since they represent the height of the man and the horizontal distance from the man to the lantern, respectively.) See the figure below. (Note that the diagram on the right shows a specific time. The diagram on the left shows a general time.)

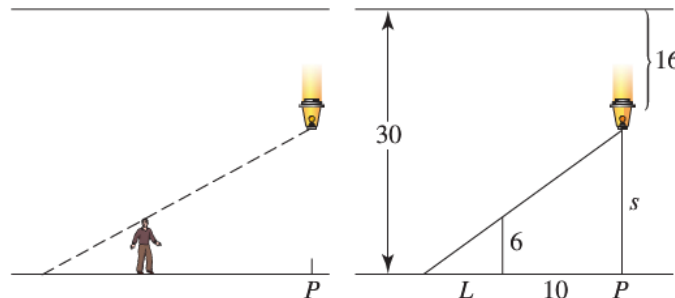

If h is the distance the lantern has already fallen then $s + h = 30$ and $h = 16t^2$. So $s = 30 - 16t^2$. Substituting $s = 30 - 16t^2$ into our previous equation and simplifying gives us the following equation that is true for all time.

$$5 - \frac{8}{3}t^2 = 1 + \frac{10}{L}$$

Differentiating with respect to time gives

$$-\frac{16}{3}t = -\frac{10}{L^2} \frac{dL}{dt}$$

Now we substitute the information relevant to the desired specific time. We substitute $t = 1$.

$$5 - \frac{8}{3} = 1 + \frac{10}{L}$$

$$-\frac{16}{3} = -\frac{10}{L^2} \frac{dL}{dt}$$

The first equation gives $L = \frac{30}{4} = 7.5$. Substituting $L = 7.5$ into the second equation gives

$$-\frac{16}{3} = -\frac{10}{(15/2)^2} \frac{dL}{dt}$$

Solving for $\frac{dL}{dt}$ gives $\frac{dL}{dt} = 30$. Hence the man's shadow is increasing at a rate of 30 feet per second.

...Alternatively, we can solve for L directly from the equation

$$5 - \frac{8}{3}t^2 = 1 + \frac{10}{L}$$

to obtain

$$L = \frac{15}{6 - 4t^2}$$

Differentiating with respect to time then gives

$$\frac{dL}{dt} = \frac{120t}{(6 - 4t^2)^2}$$

Substituting $t = 1$ then gives

$$\frac{dL}{dt} = \frac{120}{(6 - 4)^2} = \frac{120}{4} = 30$$

We recover the same answer using the previous method.

W67. The volume of a spherical balloon is increasing at constant rate of $3 \text{ in}^3/\text{s}$. At what rate is the radius of the balloon changing when the radius is 2 in.?

Solution

Let r be the radius of the balloon and let V be the volume of the balloon. Then r and V satisfy the equation

$$V = \frac{4\pi}{3}r^3$$

Differentiating with respect to time gives

$$\frac{dV}{dt} = 4\pi r^2 \frac{dr}{dt}$$

Now we substitute the information relevant to the desired specific time. We substitute $r = 2$ and $\frac{dV}{dt} = 3$.

$$\begin{aligned} V &= \frac{32\pi}{3} \\ 3 &= 16\pi \frac{dr}{dt} \end{aligned}$$

Hence $\frac{dr}{dt} = \frac{3}{16\pi}$. So the radius of the balloon is increasing at a rate of $\frac{3}{16\pi}$ inches per second.

W68. At noon, a ship sails due north from a point P at 8 knots (nautical miles per hour). Another ship, sailing at 12 knots, leaves the same point 1 hour later on a course due east. How fast is the distance between the ships increasing at 2:00 PM?

Solution

Let y be the distance from P to the ship sailing north and let x be the distance from P to the ship sailing east. If ℓ is the direct distance between the two ships, then Pythagorean theorem shows that x , y , and ℓ satisfy the equation

$$x^2 + y^2 = \ell^2$$

Differentiating with respect to time gives (after canceling a common factor of 2)

$$x \frac{dx}{dt} + y \frac{dy}{dt} = \ell \frac{d\ell}{dt}$$

Now we substitute the information relevant to the desired specific time. At 2:00 PM, the northbound ship is at a distance of $y = 8 \cdot 2 = 16$ nautical miles. At the same time, the eastbound ship is at a distance of $x = 12 \cdot 1 = 12$ nautical miles. (Note that the northbound ship has been traveling for 2 hours, but the eastbound ship has been traveling only for 1 hour.) So into our equations we substitute $x = 12$, $y = 16$, $\frac{dx}{dt} = 12$, and $\frac{dy}{dt} = 8$.

$$\begin{aligned} 12^2 + 16^2 &= \ell^2 \\ 12 \cdot 12 + 16 \cdot 8 &= \ell \frac{d\ell}{dt} \end{aligned}$$

Solving for ℓ in the first equation gives $\ell = 20$. Substituting $\ell = 20$ into the second equation gives

$$144 + 128 = 20 \frac{d\ell}{dt}$$

Hence $\frac{d\ell}{dt} = \frac{68}{5} = 13.6$. The distance between the ships is increasing at a rate of 13.6 nautical miles per hour (or 13.6 knots).

- W69.** Recall that a baseball diamond is a square of side length 90 ft. The corners of the diamond are labeled, in anti-clockwise order, home plate, first base, second base, and third base. Player A runs from home plate to first base at a speed of 20 ft/s. How fast is the player's distance from second base changing when the player is halfway to first base?

Solution

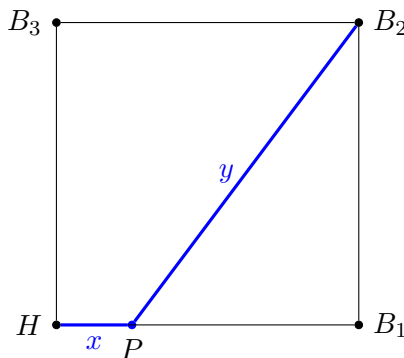

The bases are labeled H , B_1 , B_2 , and B_3 , in order. The player is at point P . The current distance from home plate to the player is x and the current distance from the player to second base is y . Since each side of the square is 90 feet long, Pythagorean theorem gives us

$$y^2 = 90^2 + (90 - x)^2 \quad (5)$$

Differentiating with respect to time gives

$$2y \frac{dy}{dt} = -2(90 - x) \frac{dx}{dt} \quad (6)$$

We are interested in the time when the player is halfway to first base and we know the player runs at a constant speed of 20 ft/s. So we substitute $\frac{dx}{dt} = 20$ and $x = 45$ into equations (5) and

(6).

$$y^2 = 90^2 + 45^2$$
$$2y \frac{dy}{dt} = -1800$$

Solving these equations simultaneously for $\frac{dy}{dt}$ gives

$$\frac{dy}{dt} = -\frac{1800}{\sqrt{90^2 + 45^2}} = -4\sqrt{5} \text{ ft/s}$$

W70. A particle moves along the elliptical path given by $x^2 + 9y^2 = 13$ in such a way that when it is at the point $(-2, 1)$, its x -coordinate is decreasing at the rate of 7 units per second. How fast is the y -coordinate changing at that instant?

Solution

Differentiating the equation $x^2 + 9y^2 = 13$ with respect to time gives

$$2x \frac{dx}{dt} + 18y \frac{dy}{dt} = 0$$

Now we substitute $x = -2$, $y = 1$, and $\frac{dx}{dt} = -7$ to get the following.

$$28 + 18 \frac{dy}{dt} = 0$$

Hence we find $\frac{dy}{dt} = -14/9$ units per second. That is, the y -coordinate is decreasing at a rate of $14/9$ units per second.

2.4 Chapter 4: Applications of the Derivative

§4.1: Maxima and Minima

*Difficulty guide for this worksheet:**Core or Beyond Core:* 71 (all parts except f), 72*Advanced:* none*Removed from syllabus:* 71f

W71. For each part, find the absolute maximum and the absolute minimum of the function f on the given interval. You may use a scientific calculator for parts (k) and (l) only.

- | | |
|---|---|
| (a) $f(x) = x^4 - 8x^2$ on $[-3, 3]$ | (g) $f(x) = 2x^3 - 9x^2 + 12x$ on $[0, 3]$ |
| (b) $f(x) = x^3 + 3x^2 - 24x - 72$ on $[-4, 4]$ | (h) $f(x) = \frac{1-x}{x^2+3x}$ on $[1, 4]$ |
| (c) $f(x) = \sqrt{x}(x-5)^{1/3}$ on $[0, 6]$ | (i) $f(x) = x - 2\sin(x)$ on $[0, 2\pi]$ |
| (d) $f(x) = e^{-x}\sin(x)$ on $[0, 2\pi]$ | (j) $f(x) = (x-x^2)^{1/3}$ on $[-1, 2]$ |
| (e) $f(x) = x(\ln(x) - 5)^2$ on $[e^{-4}, e^4]$ | (k) $f(x) = x^3 - 24\ln(x)$ on $[\frac{1}{2}, 3]$ |
| (f) $f(x) = \begin{cases} 9-4x & , x < 1 \\ -x^2+6x & , x \geq 1 \end{cases}$ on $[0, 4]$ | (l) $f(x) = 3e^x - e^{2x}$ on $[-\frac{1}{2}, 1]$ |

Solution

(a) The function f is differentiable everywhere. So we solve $f'(x) = 0$.

$$0 = f'(x) = 4x^3 - 16x$$

$$0 = 4x(x-2)(x+2)$$

Hence the critical points are $x = -2$, $x = 0$, and $x = 2$. Checking the critical values and the endpoint values gives the following.

$$f(x) = x^4 - 8x^2 = x^2(x^2 - 8)$$

$$f(-3) = 9$$

$$f(-2) = -16$$

$$f(0) = 0$$

$$f(2) = -16$$

$$f(3) = 9$$

The maximum value of f on $[-3, 3]$ is 9 and the minimum value is -16 .

(b) The function f is differentiable everywhere. So we solve $f'(x) = 0$.

$$0 = f'(x) = 3x^2 + 6x - 24$$

$$0 = 3(x-2)(x+4)$$

Hence the critical points are $x = -4$ and $x = 2$. Checking the critical values and the endpoint values gives the following.

$$f(x) = x^3 + 3x^2 - 24x - 72 = (x^2 - 24)(x + 3)$$

$$f(-4) = (-8)(-1) = 8$$

$$f(2) = (-20)(5) = -100$$

$$f(4) = (-8)(7) = -56$$

The maximum value of f on $[-4, 4]$ is 8 and the minimum value is -100 .

- (c) The function f is not differentiable at $x = 5$, hence $x = 5$ is a critical point. To find the other critical points we solve the equation $f'(x) = 0$.

$$\begin{aligned} 0 &= f'(x) = x^{1/2} \cdot \frac{1}{3}(x-5)^{-2/3} + \frac{1}{2}x^{-1/2}(x-5)^{1/3} \\ 0 &= \frac{1}{6}x^{-1/2}(x-5)^{-2/3}(2x+3(x-5)) \\ 0 &= \frac{1}{6}x^{-1/2}(x-5)^{-2/3}(5x-15) \end{aligned}$$

Solving this equation thus gives $5x - 15 = 0$ (that is, $x = 3$). Checking the critical values and the endpoint values gives the following.

$$\begin{aligned} f(x) &= x^{1/2}(x-5)^{1/3} \\ f(0) &= 0 \\ f(3) &= 3^{1/2}(-2)^{1/3} \quad (\text{negative number}) \\ f(5) &= 0 \\ f(6) &= 6^{1/2} \quad (\text{positive number}) \end{aligned}$$

The maximum value of f on $[0, 6]$ is $6^{1/2}$ and the minimum value is $3^{1/2}(-2)^{1/3}$.

- (d) The function f is differentiable everywhere. So we solve $f'(x) = 0$.

$$\begin{aligned} 0 &= f'(x) = e^{-x} \cos(x) - e^{-x} \sin(x) \\ 0 &= e^{-x} (\cos(x) - \sin(x)) \end{aligned}$$

Solving this equation thus gives $\cos(x) - \sin(x) = 0$ (that is, $\tan(x) = 1$). In the interval $[0, 2\pi]$ the equation $\tan(x) = 1$ has solutions $x = \frac{\pi}{4}$ and $\frac{5\pi}{4}$. Checking the critical values and the endpoint values gives the following.

$$\begin{aligned} f(x) &= e^{-x} \sin(x) \\ f(0) &= 0 \\ f\left(\frac{\pi}{4}\right) &= e^{-\pi/4} \cdot \frac{1}{\sqrt{2}} \quad (\text{positive number}) \\ f\left(\frac{5\pi}{4}\right) &= -e^{-5\pi/4} \cdot \frac{1}{\sqrt{2}} \quad (\text{negative number}) \\ f(2\pi) &= 0 \end{aligned}$$

The maximum value of f on $[0, 2\pi]$ is $\frac{e^{-\pi/4}}{\sqrt{2}}$ and the minimum value is $-\frac{e^{-5\pi/4}}{\sqrt{2}}$.

- (e) The function f is differentiable on its domain. So we solve $f'(x) = 0$.

$$\begin{aligned} 0 &= f'(x) = x \cdot 2(\ln(x) - 5) \cdot \frac{1}{x} + (\ln(x) - 5)^2 \\ 0 &= 2(\ln(x) - 5) + (\ln(x) - 5)^2 \\ 0 &= (\ln(x) - 5)(2 + \ln(x) - 5) \\ 0 &= (\ln(x) - 5)(\ln(x) - 3) \end{aligned}$$

Solving this equation thus gives $\ln(x) - 5 = 0$ (that is, $x = e^5$) or $\ln(x) - 3 = 0$ (that is, $x = e^3$). The only critical point is thus $x = e^3$ (e^5 is not in the interval $[e^{-4}, e^4]$). Checking

the critical values and the endpoint values gives the following.

$$\begin{aligned} f(x) &= x(\ln(x) - 5)^2 \\ f(e^{-4}) &= e^{-4}(-4 - 5)^2 = \frac{81}{e^4} \\ f(e^3) &= e^3(3 - 5)^2 = 4e^3 \\ f(e^4) &= e^4(4 - 5)^2 = e^4 \end{aligned}$$

To determine which value is the largest and which is the smallest, we look at the ratios of the above values. We will use the fact that $2 < e < 4$.

$$\frac{f(e^3)}{f(e^4)} = \frac{4e^3}{e^4} = \frac{4}{e} > \frac{e}{e} = 1$$

Hence $f(e^3) > f(e^4)$. We also have

$$\frac{f(e^4)}{f(e^{-4})} = \frac{e^4}{\frac{81}{e^4}} = \frac{e^8}{81} > \frac{2^8}{81} = \frac{256}{81} > 1$$

Hence $f(e^4) > f(e^{-4})$. Putting this all together we find the following.

$$4e^3 > e^4 > \frac{81}{e^4}$$

The maximum value of f on $[e^{-4}, e^4]$ is $4e^3$ and the minimum value is $\frac{81}{e^4}$.

- (f) First observe that f is continuous (the left-limit, right-limit, and function value are all equal to 5 at $x = 1$, the only suspicious point). So the extreme value theorem does apply to f on the interval $[0, 4]$.

The derivative of f is given by

$$f'(x) = \begin{cases} -4 & , x < 1 \\ -2x + 6 & , x > 1 \end{cases}$$

The function f is not differentiable at $x = 1$. We may verify this by computing the following limit.

$$f'(1) = \lim_{h \rightarrow 0} \left(\frac{f(1+h) - f(1)}{h} \right) = \lim_{h \rightarrow 0} \left(\frac{f(1+h) - 5}{h} \right)$$

Since $f(1+h)$ is defined differently depending on whether h is negative or positive, we compute the one-sided limits.

$$\begin{aligned} \lim_{h \rightarrow 0^-} \left(\frac{f(1+h) - 5}{h} \right) &= \lim_{h \rightarrow 0^-} \left(\frac{9 - 4(1+h) - 5}{h} \right) \\ &= \lim_{h \rightarrow 0^-} \left(\frac{-4h}{h} \right) = \lim_{h \rightarrow 0^-} (-4) = -4 \\ \lim_{h \rightarrow 0^+} \left(\frac{f(1+h) - 5}{h} \right) &= \lim_{h \rightarrow 0^+} \left(\frac{-(1+h)^2 + 6(1+h) - 5}{h} \right) \\ &= \lim_{h \rightarrow 0^+} \left(\frac{-h^2 + 4h}{h} \right) = \lim_{h \rightarrow 0^+} (-h + 4) = 4 \end{aligned}$$

Since the two one-sided limits are not equal, $f'(1)$ does not exist. This means $x = 1$ is a critical point of f on the interval $[0, 4]$.

To find any other critical point of f we solve the equation $f'(x) = 0$. Note that the “first piece” of $f'(x)$ (i.e., -4) is never equal to 0. Hence we only set the “second piece” of $f'(x)$ (i.e., $-2x + 6$) equal to 0. The equation $-2x + 6 = 0$ has the solution $x = 3$. (Also observe that $x = 3$ lies in the interval $x > 1$, i.e., the valid x -values for the “second piece” of $f'(x)$.)

Checking the critical values and endpoint values gives the following.

$$f(x) = \begin{cases} 9 - 4x & , \quad x < 1 \\ -x^2 + 6x & , \quad x \geq 1 \end{cases}$$

$$f(0) = 9$$

$$f(1) = 5$$

$$f(3) = 9$$

$$f(4) = 8$$

The maximum value of f on $[0, 4]$ is 9 and the minimum value is 5.

- (g) The function f is differentiable everywhere on $(0, 3)$, so the only critical points are those x -values where f' vanishes.

$$0 = f'(x) = 6x^2 - 18x + 12 = 6(x - 1)(x - 2)$$

Hence the only critical points in $[0, 3]$ are $x = 1, 2$. We now check the values of the function at the critical points and the endpoints.

$$f(0) = 0$$

$$f(1) = 5$$

$$f(2) = 4$$

$$f(3) = 9$$

Hence the minimum value of f is 0 and the maximum value of f is 9.

- (h) The function f is differentiable everywhere on $(1, 4)$, so the only critical points are those x -values where f' vanishes.

$$0 = f'(x) = \frac{(x^2 + 3x)(-1) - (1 - x)(2x + 3)}{(x^2 + 3x)^2} = \frac{(x - 3)(x + 1)}{(x^2 + 3x)^2}$$

Hence the only critical point in $[1, 4]$ is $x = 3$. We now check the values of the function at the critical points and the endpoints.

$$f(1) = 0$$

$$f(3) = -\frac{1}{9}$$

$$f(4) = -\frac{3}{28}$$

Hence the minimum value of f is $-\frac{1}{9}$ and the maximum value of f is 0.

- (i) The function f is differentiable everywhere on $(0, 2\pi)$, so the only critical points are those x -values where f' vanishes.

$$0 = f'(x) = 1 - 2\cos(x)$$

Hence the only critical points in $[0, 2\pi]$ are $x = \frac{\pi}{3}, \frac{5\pi}{3}$. We now check the values of the function at the critical points and the endpoints.

$$\begin{aligned} f(0) &= 0 \\ f\left(\frac{\pi}{3}\right) &= \frac{\pi}{3} - \sqrt{3} < 0 \\ f\left(\frac{5\pi}{3}\right) &= \frac{5\pi}{3} + \sqrt{3} = 2\pi - \left(\frac{\pi}{3} - \sqrt{3}\right) > 2\pi \\ f(2\pi) &= 2\pi \end{aligned}$$

Hence the minimum value of f is $\frac{\pi}{3} - \sqrt{3}$ and the maximum value of f is $\frac{5\pi}{3} + \sqrt{3}$.

- (j) The function f is differentiable everywhere on $(-1, 2)$, except where $x - x^2 = 0$. Hence $x = 0, 1$ are critical points. The only other critical points are those x -values where f' vanishes.

$$0 = f'(x) = \frac{1}{3}(x - x^2)^{-2/3}(1 - 2x)$$

Hence the only other critical point in $[-1, 2]$ is $x = \frac{1}{2}$. We now check the values of the function at the critical points and the endpoints.

$$\begin{aligned} f(-1) &= -2^{1/3} \\ f(0) &= 0 \\ f\left(\frac{1}{2}\right) &= 4^{-1/3} \\ f(1) &= 0 \\ f(2) &= -2^{1/3} \end{aligned}$$

Hence the minimum value of f is $-2^{1/3}$ and the maximum value of f is $4^{-1/3}$.

- (k) The function f is differentiable everywhere on $(\frac{1}{2}, 3)$, so the only critical points are those x -values where f' vanishes.

$$0 = f'(x) = 3x^2 - \frac{24}{x} = \frac{3(x^3 - 8)}{x}$$

Hence the only critical point in $[\frac{1}{2}, 3]$ is $x = 2$. We now check the values of the function at the critical points and the endpoints.

$$\begin{aligned} f\left(\frac{1}{2}\right) &= \frac{1}{8} + 24 \ln(2) \approx 16.76 \\ f(2) &= 8 - 24 \ln(2) \approx -8.635 \\ f(3) &= 27 - 24 \ln(3) \approx 0.633 \end{aligned}$$

Hence the minimum value of f is $8 - 24 \ln(2)$ and the maximum value of f is $\frac{1}{8} + 24 \ln(2)$.

- (l) The function f is differentiable everywhere on $(-\frac{1}{2}, 1)$, so the only critical points are those x -values where f' vanishes.

$$0 = f'(x) = 3e^x - 2e^{2x} = e^x(3 - 2e^x)$$

Hence the only critical point in $[-\frac{1}{2}, 1]$ is $x = \ln(\frac{3}{2})$. We now check the values of the function at the critical points and the endpoints.

$$f(-\frac{1}{2}) = 3e^{-1/2} - e^{-1} \approx 1.45$$

$$f(\ln(\frac{3}{2})) = \frac{9}{4} = 2.25$$

$$f(1) = 3e - e^2 \approx 0.766$$

Hence the minimum value of f is $3e - e^2$ and the maximum value of f is $\frac{9}{4}$.

W72. A particle moves along the x axis with position

$$x(t) = t^4 - 2t^3 - 12t^2 + 60t - 10$$

Find the particle's minimum velocity for $0 \leq t \leq 3$.

Solution

The velocity of the particle is

$$v(t) = \frac{dx}{dt} = 4t^3 - 6t^2 - 24t + 60$$

We must find the maximum value of $v(t)$. Since $v(t)$ is differentiable on all intervals, the critical points of $v(t)$ are those values of t for which $v'(t) = 0$.

$$0 = v'(t) = 12t^2 - 12t - 24$$

$$0 = 12(t^2 - t - 2) = 12(t - 2)(t + 1)$$

The only critical point is $t = 2$ (the value $t = -1$ is not in the interval $[0, 3]$). Now we check the values of v at the critical point and the endpoints of the interval.

$$v(0) = 60$$

$$v(2) = 20$$

$$v(3) = 42$$

Hence the particle's minimum velocity is $v(2) = 20$.

§4.3, 4.4: What Derivatives Tell Us and Graphing Functions

Difficulty guide for this worksheet:

Core or Beyond Core: 73 (all parts except g, j, k, and l), 74, 75

Advanced: 73g, 73j, 73k, 73l

Removed from syllabus: none

This worksheet assumes knowledge of §4.7 (Lôspital's Rule).

W73. For each function, do all of the following.

- Calculate and fully simplify $f'(x)$ and $f''(x)$.
- Find all vertical asymptotes and all horizontal asymptotes.
- Find all first-order critical numbers.
- Find where the function is increasing and where the function is decreasing.
- Classify each critical value as a relative maximum, relative minimum, or neither.
- Find all second-order critical numbers.
- Find where the graph of $y = f(x)$ is concave up and where it is concave down.
- Identify any inflection points.
- Sketch the graph of $y = f(x)$.

(a) $f(x) = \frac{1}{3}x^3 - 9x + 2$

(e) $f(x) = 1 + 2x + 18x^{-1}$

(j) $f(x) = \frac{1}{x^3 + 8}$

(b) $f(x) = (x + 1)^2(x - 5)$

(f) $f(x) = 1 - \frac{x}{4 - x}$

(k) $f(x) = \frac{x^3}{x - 1}$

(c) $f(x) = \frac{x}{x^2 + 1}$

(g) $f(x) = \sqrt[3]{x^3 - 48x}$

(l) $f(x) = \frac{1}{x^3 - 3x}$

(d) $f(x) = x - \sin(2x)$
(on $[0, \pi]$ only)

(h) $f(x) = \ln(4 - x^2)$

(i) $f(x) = 10x^3 - x^5$

Solution

(a) The derivatives of f are

$$f'(x) = x^2 - 9 \quad , \quad f''(x) = 2x$$

(i) *Vertical asymptotes and horizontal asymptotes.*

Since f is a polynomial, there are no asymptotes.

(ii) *Intervals of increase and local extrema.*

Since f is differentiable everywhere, the only first-order critical numbers are solutions to $f'(x) = 0$.

$$x^2 - 9 = 0 \implies x = -3 \text{ or } x = 3$$

(iii) *Intervals of concavity and inflection points.*

We make a sign chart for $f'(x)$.

interval	test point	sign	shape
$(-\infty, -3)$	$f'(-4) = 5$	\oplus	increasing
$(-3, 3)$	$f'(0) = -9$	\ominus	decreasing
$(3, \infty)$	$f'(4) = 5$	\oplus	increasing

(iv) *Sketch of graph.*

There is a local maximum at $(-3, 20)$ and a local minimum at $(3, -16)$.

Since f is twice-differentiable everywhere, the only second-order critical numbers are solutions to $f''(x) = 0$.

$$2x = 0 \implies x = 0$$

We make a sign chart for $f''(x)$.

interval	test point	sign	shape
$(-\infty, 0)$	$f''(-1) = -2$	\ominus	concave down
$(0, \infty)$	$f''(1) = 2$	\oplus	concave up

There is a point of inflection at $(0, 2)$.

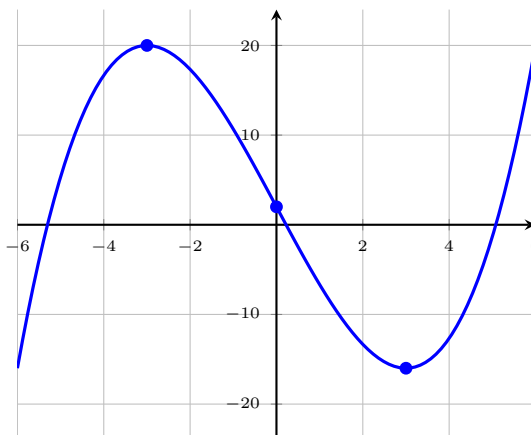

(b) The derivatives of f are

$$f'(x) = 3(x+1)(x-3) \quad , \quad f''(x) = 6(x-1)$$

(i) *Vertical asymptotes and horizontal asymptotes.*

Since f is a polynomial, there are no asymptotes.

(ii) *Intervals of increase and local extrema.*

Since f is differentiable everywhere, the only first-order critical numbers are solutions to $f'(x) = 0$.

$$3(x+1)(x-3) = 0 \implies x = -1 \text{ or } x = 3$$

(iii) *Intervals of concavity and inflection points.*

We make a sign chart for $f'(x)$.

interval	test point	sign	shape
$(-\infty, -1)$	$f'(-2) = 3\ominus\ominus$	\oplus	increasing
$(-1, 3)$	$f'(0) = 3\oplus\ominus$	\ominus	decreasing
$(3, \infty)$	$f'(4) = 3\oplus\oplus$	\oplus	increasing

(iv) *Sketch of graph.*

There is a local maximum at $(-1, 0)$ and a local minimum at $(3, -32)$.

Since f is twice-differentiable everywhere, the only second-order critical numbers are solutions to $f''(x) = 0$.

$$6(x - 1) = 0 \implies x = 1$$

We make a sign chart for $f''(x)$.

interval	test point	sign	shape
$(-\infty, 1)$	$f''(0) = 6\ominus$	\ominus	concave down
$(1, \infty)$	$f''(2) = 6\oplus$	\oplus	concave up

There is a point of inflection at $(1, -16)$.

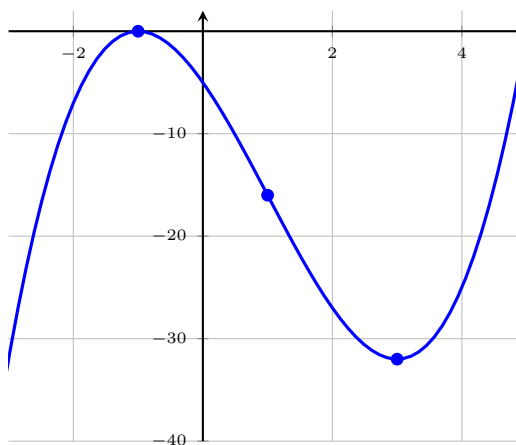

(c) The derivatives of f are

$$f'(x) = \frac{1 - x^2}{(x^2 + 1)^2}, \quad f''(x) = \frac{2x(x^2 - 3)}{(x^2 + 1)^3}$$

(i) *Vertical asymptotes and horizontal asymptotes.*

Since f is continuous for all x , there are no vertical asymptotes. Now we have the following.

$$\lim_{x \rightarrow \pm\infty} \left(\frac{x}{x^2 + 1} \right) \stackrel{H}{=} \lim_{x \rightarrow \pm\infty} \left(\frac{1}{2x} \right) = 0$$

So the only horizontal asymptote is the line $y = 0$.

(ii) *Intervals of increase and local extrema.*

Since f is differentiable everywhere, the only first-order critical numbers are solutions to $f'(x) = 0$.

$$\frac{1 - x^2}{(x^2 + 1)^2} = 0 \implies x = -1 \text{ or } x = 1$$

(iii) *Intervals of concavity and inflection points.*

We make a sign chart for $f'(x)$.

interval	test point	sign	shape
$(-\infty, -1)$	$f'(-2) = \ominus$	\ominus	decreasing
$(-1, 1)$	$f'(0) = \oplus$	\oplus	increasing
$(1, \infty)$	$f'(2) = \ominus$	\ominus	decreasing

(iv) *Sketch of graph.*

There is a local minimum at $(-1, -\frac{1}{2})$ and a local maximum at $(1, \frac{1}{2})$.

Since f is twice-differentiable everywhere, the only second-order critical numbers are solutions to $f''(x) = 0$.

$$\frac{2x(x^2 - 3)}{(x^2 + 1)^3} = 0 \implies x = -\sqrt{3} \text{ or } x = 0 \text{ or } x = \sqrt{3}$$

We make a sign chart for $f''(x)$.

interval	test point	sign	shape
$(-\infty, -\sqrt{3})$	$f''(-2) = \ominus$	\ominus	concave down
$(-\sqrt{3}, 0)$	$f''(-1) = \oplus$	\oplus	concave up
$(0, \sqrt{3})$	$f''(1) = \ominus$	\ominus	concave down
$(\sqrt{3}, \infty)$	$f''(2) = \oplus$	\oplus	concave up

There are points of inflection at $(-\sqrt{3}, -\frac{\sqrt{3}}{4})$, $(0, 0)$, and $(\sqrt{3}, \frac{\sqrt{3}}{4})$.

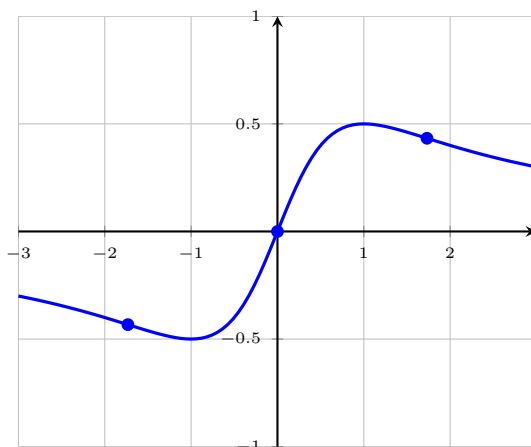

(d) The derivatives of f are

$$f'(x) = 1 - 2\cos(2x) \quad , \quad f''(x) = 4\sin(2x)$$

(i) *Vertical asymptotes and horizontal asymptotes.*

Since f is continuous for all x , there are no vertical asymptotes. Since the domain of f is bounded, it makes no sense to compute the limit of f as $x \rightarrow \pm\infty$, so there are no horizontal asymptotes.

(ii) *Intervals of increase and local extrema.*

Since f is differentiable everywhere, the only first-order critical numbers are solutions to $f'(x) = 0$.

$$1 - 2\cos(2x) = 0 \implies x = \frac{\pi}{6}, \frac{5\pi}{6}, \frac{7\pi}{6}, \frac{11\pi}{6}$$

(iii) *Intervals of concavity and inflection points.*

We make a sign chart for $f'(x)$.

interval	test point	sign	shape
$[0, \frac{\pi}{6})$	$f'(0) = 1 - 2 = -1$	\ominus	decreasing
$(\frac{\pi}{6}, \frac{5\pi}{6})$	$f'(\frac{\pi}{2}) = 1 - (-2) = 3$	\oplus	increasing
$(\frac{5\pi}{6}, \frac{7\pi}{6})$	$f'(\pi) = 1 - 2 = -1$	\ominus	decreasing
$(\frac{7\pi}{6}, \frac{11\pi}{6})$	$f'(\frac{3\pi}{2}) = 1 - (-2) = 3$	\oplus	increasing
$(\frac{11\pi}{6}, 2\pi]$	$f'(2\pi) = 1 - 2 = -1$	\ominus	decreasing

(iv) *Sketch of graph.*

There are local minima at the points $(\frac{\pi}{6}, \frac{\pi}{6} - \frac{\sqrt{3}}{2})$, $(\frac{7\pi}{6}, \frac{7\pi}{6} - \frac{\sqrt{3}}{2})$, and $(2\pi, 2\pi)$. There are local maxima at the points $(0, 0)$, $(\frac{5\pi}{6}, \frac{5\pi}{6} + \frac{\sqrt{3}}{2})$, and $(\frac{11\pi}{6}, \frac{11\pi}{6} + \frac{\sqrt{3}}{2})$.

Since f is twice-differentiable everywhere, the only second-order critical numbers are solutions to $f''(x) = 0$.

$$4 \sin(2x) = 0 \implies x = 0, \frac{\pi}{2}, \pi, \frac{3\pi}{2}$$

We make a sign chart for $f''(x)$.

interval	test point	sign	shape
$(0, \frac{\pi}{2})$	$f''(\frac{\pi}{4}) = 4$	\oplus	concave up
$(\frac{\pi}{2}, \pi)$	$f''(\frac{3\pi}{4}) = -4$	\ominus	concave down
$(\pi, \frac{3\pi}{2})$	$f''(\frac{5\pi}{4}) = 4$	\oplus	concave up
$(\frac{3\pi}{2}, 2\pi)$	$f''(\frac{7\pi}{4}) = -4$	\ominus	concave down

There are points of inflection at $(\frac{\pi}{2}, \frac{\pi}{2})$, (π, π) , and $(\frac{3\pi}{2}, \frac{3\pi}{2})$.

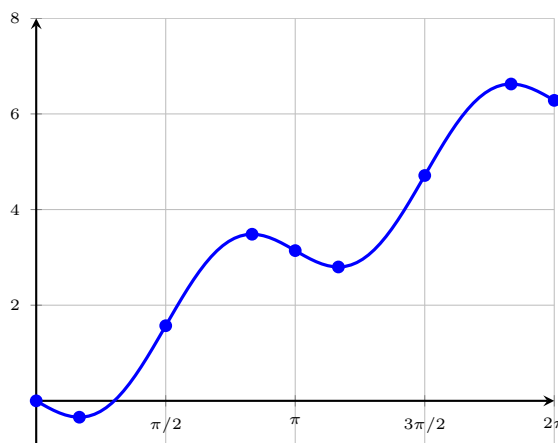

(e) The derivatives of f are

$$f'(x) = 2 - \frac{18}{x^2} = \frac{2(x-3)(x+3)}{x^2}, \quad f''(x) = \frac{36}{x^3}$$

(i) *Vertical asymptotes and horizontal asymptotes.*

Observe that f is continuous on its domain, but is undefined for $x = 0$. Hence our candidate vertical asymptote is the line $x = 0$. Indeed, direct substitution of $x = 0$ into the term $\frac{18}{x}$ gives the expression $\frac{18}{0}$, which indicates that both one-sided limits are infinite. We need only perform a sign analysis to determine the sign of infinity.

$$\lim_{x \rightarrow 0^-} \left(1 + 2x + \frac{18}{x} \right) = \lim_{x \rightarrow 0^-} \left(\frac{x + 2x^2 + 18}{x} \right) = \frac{18}{0^-} = -\infty$$

Note that we have used that fact that if $x \rightarrow 0^-$, then x approaches 0 but remains negative. Similarly, we have

$$\lim_{x \rightarrow 0^+} \left(1 + 2x + \frac{18}{x} \right) = \lim_{x \rightarrow 0^+} \left(\frac{x + 2x^2 + 18}{x} \right) = \frac{18}{0^+} = \infty$$

Hence the line $x = 0$ is a true vertical asymptote.

As for the horizontal asymptotes we have the following.

$$\lim_{x \pm \infty} \left(1 + 2x + \frac{18}{x} \right) = 1 + 2(\pm\infty) + 0 = \pm\infty$$

Since neither limit (as either $x \rightarrow -\infty$ or $x \rightarrow \infty$) is finite, there are no horizontal asymptotes.

(ii) *Intervals of increase and local extrema.*

Since f is differentiable on its domain, the only first-order critical numbers are solutions to $f'(x) = 0$.

$$\frac{2(x-3)(x+3)}{x^2} = 0 \implies x = -3, 3$$

(iii) *Intervals of concavity and inflection points.*

We make a sign chart for $f'(x)$. Recall that since $x = 0$ is not in the domain of f , we must include $x = 0$ on our sign chart.

interval	test point	sign	shape
$(-\infty, -3)$	$f'(-4) = \frac{2\ominus\ominus}{\oplus}$	\oplus	increasing
$(-3, 0)$	$f'(-1) = \frac{2\ominus\oplus}{\oplus}$	\ominus	decreasing
$(0, 3)$	$f'(1) = \frac{2\ominus\oplus}{\oplus}$	\ominus	decreasing
$(3, \infty)$	$f'(4) = \frac{2\oplus\oplus}{\oplus}$	\oplus	increasing

(iv) *Sketch of graph.*

There is a local maximum at $(-3, -11)$ and a local minimum at $(3, 13)$.

Since f is twice-differentiable on its domain, the only second-order critical numbers are solutions to $f''(x) = 0$.

$$\frac{36}{x^3} = 0 \implies \text{no solution}$$

We make a sign chart for $f''(x)$. Recall that since $x = 0$ is not in the domain of f , we must include $x = 0$ on our sign chart.

interval	test point	sign	shape
$(-\infty, 0)$	$f''(-1) = \frac{36}{\ominus}$	\ominus	concave down
$(0, \infty)$	$f''(1) = \frac{36}{\oplus}$	\oplus	concave up

There are no points of inflection.

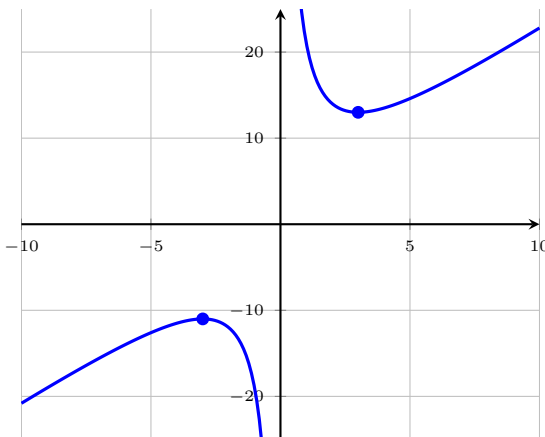

(f) The derivatives of f are

$$f'(x) = \frac{-4}{(x-4)^2}, \quad f''(x) = \frac{8}{(x-4)^3}$$

(i) *Vertical asymptotes and horizontal asymptotes.*

Observe that f is continuous on its domain, but is undefined for $x = 4$. Hence our candidate vertical asymptote is the line $x = 4$. Indeed, direct substitution of $x = 4$ into the second term of f gives the expression $\frac{4}{0}$, which indicates that both one-sided limits are infinite. We need only perform a sign analysis to determine the sign of infinity.

$$\lim_{x \rightarrow 4^-} \left(1 - \frac{x}{4-x}\right) = \lim_{x \rightarrow 0^-} \left(\frac{4-2x}{4-x}\right) = \frac{-8}{0^+} = -\infty$$

Note that we have used that fact that if $x \rightarrow 4^-$, then $4-x$ approaches 0 but remains positive. Similarly, we have

$$\lim_{x \rightarrow 4^+} \left(1 - \frac{x}{4-x}\right) = \lim_{x \rightarrow 0^+} \left(\frac{4-2x}{4-x}\right) = \frac{-8}{0^-} = \infty$$

Hence the line $x = 4$ is a true vertical asymptote.

As for the horizontal asymptotes we have the following.

$$\lim_{x \rightarrow \pm\infty} \left(1 - \frac{x}{4-x}\right) = \lim_{x \rightarrow \pm\infty} \left(\frac{4-2x}{4-x}\right) \stackrel{H}{=} \lim_{x \rightarrow \pm\infty} \left(\frac{-2}{-1}\right) = 2$$

Hence the only horizontal asymptote is the line $y = 2$.

(ii) *Intervals of increase and local extrema.*

Since f is differentiable on its domain, the only first-order critical numbers are solutions to $f'(x) = 0$.

$$\frac{-4}{(x-4)^2} = 0 \implies \text{no solution}$$

(iii) *Intervals of concavity and inflection points.*

We make a sign chart for $f'(x)$. Recall that since $x = 4$ is not in the domain of f , we must include $x = 4$ on our sign chart.

interval	test point	sign	shape
$(-\infty, 4)$	$f'(0) = \frac{-4}{\oplus}$	\ominus	decreasing
$(4, \infty)$	$f'(5) = \frac{-4}{\oplus}$	\ominus	decreasing

(iv) *Sketch of graph.*

There are no local extrema.

Since f is twice-differentiable on its domain, the only second-order critical numbers are solutions to $f''(x) = 0$.

$$\frac{8}{(x-4)^3} = 0 \implies \text{no solution}$$

We make a sign chart for $f''(x)$. Recall that since $x = 4$ is not in the domain of f , we must include $x = 4$ on our sign chart.

interval	test point	sign	shape
$(-\infty, 4)$	$f''(0) = \frac{8}{\ominus}$	\ominus	concave down
$(4, \infty)$	$f''(5) = \frac{8}{\oplus}$	\oplus	concave up

There are no points of inflection.

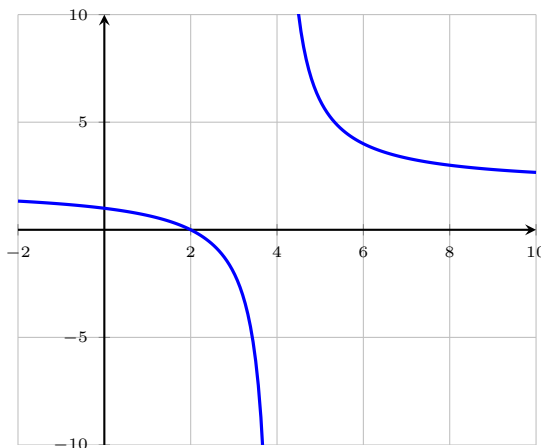

(g) The derivatives of f are

$$f'(x) = \frac{x^2 - 16}{(x^3 - 48x)^{2/3}}, \quad f''(x) = \frac{-32(x^2 + 16)}{(x^3 - 48x)^{5/3}}$$

(i) *Vertical asymptotes and horizontal asymptotes.*

Since f is continuous for all real numbers, there are no vertical asymptotes. As for the horizontal asymptotes, we have

$$\lim_{x \rightarrow \pm\infty} (x^3 - 48x)^{1/3} = \lim_{x \rightarrow \pm\infty} \left(x \cdot \left(1 - \frac{48}{x^2} \right)^{1/3} \right) = \pm\infty \cdot (1 - 0)^{1/3} = \pm\infty$$

Hence there are no horizontal asymptotes.

(ii) *Intervals of increase and local extrema.*

First observe that f is not differentiable when $x^3 - 48x = 0$, or at $x = -\sqrt{48}, 0, \sqrt{48}$. So these three numbers are first-order critical numbers. We also get first-order critical numbers as solutions to $f'(x) = 0$.

$$\frac{x^2 - 16}{(x^3 - 48x)^{2/3}} = 0 \implies x = -4, 4$$

(iii) *Intervals of concavity and inflection points.*

We make a sign chart for $f'(x)$.

interval	test point	sign	shape
$(-\infty, -\sqrt{48})$	$f'(-7) = \frac{\oplus}{\oplus}$	\oplus	increasing
$(-\sqrt{48}, -4)$	$f'(-5) = \frac{\oplus}{\oplus}$	\oplus	increasing
$(-4, 0)$	$f'(-3) = \frac{\ominus}{\oplus}$	\ominus	decreasing
$(0, 4)$	$f'(3) = \frac{\ominus}{\oplus}$	\ominus	decreasing
$(4, \sqrt{48})$	$f'(5) = \frac{\oplus}{\oplus}$	\oplus	increasing
$(\sqrt{48}, \infty)$	$f'(7) = \frac{\oplus}{\oplus}$	\oplus	increasing

(iv) *Sketch of graph.*

There is a local maximum at $(-4, 4\sqrt[3]{2})$ and a local minimum at $(4, -4\sqrt[3]{2})$.

First observe that f is not twice-differentiable when $x^3 - 48x = 0$, or at $x = -\sqrt{48}, 0, \sqrt{48}$. So these three numbers are second-order critical numbers. We also get second-order critical numbers as solutions to $f''(x) = 0$.

$$\frac{-32(x^2 + 16)}{(x^3 - 48x)^{5/3}} = 0 \implies \text{no solution}$$

We make a sign chart for $f''(x)$.

interval	test point	sign	shape
$(-\infty, -\sqrt{48})$	$f''(-7) = \frac{-32\oplus}{\oplus}$	\ominus	concave up
$(-\sqrt{48}, 0)$	$f''(-1) = \frac{-32\oplus}{\ominus}$	\oplus	concave down
$(0, \sqrt{48})$	$f''(1) = \frac{-32\oplus}{\oplus}$	\ominus	concave up
$(\sqrt{48}, \infty)$	$f''(7) = \frac{-32\oplus}{\ominus}$	\oplus	concave down

There are points of inflection at $(-\sqrt{48}, 0)$, $(0, 0)$, and $(\sqrt{48}, 0)$. We have not covered this in class, but note the following

$$\lim_{x \rightarrow 0^-} f'(x) = -\infty, \quad \lim_{x \rightarrow 0^+} f'(x) = -\infty$$

Since the derivative has an infinite limit and it is the same sign of infinity for both one-sided limits, there is a vertical tangent at $x = 0$. Similarly, there is a vertical tangent at both $x = -\sqrt{48}$ and $x = \sqrt{48}$ also.

If this were a quiz or exam problem, a graph sketch would not be asked, but the other parts of this problem are perfectly acceptable problems.

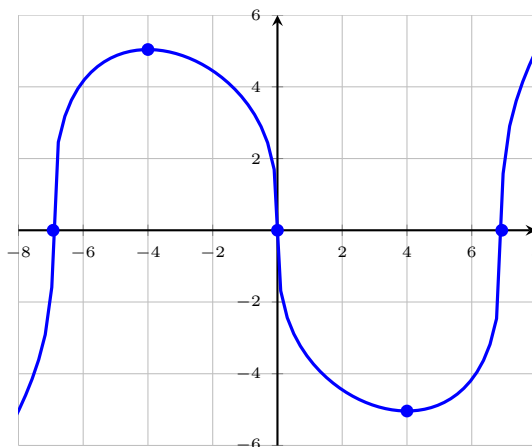

(h) The derivatives of f are

$$f'(x) = \frac{-2x}{4-x^2}, \quad f''(x) = \frac{-2(x^2+4)}{(x^2-4)^2}$$

(i) *Vertical asymptotes and horizontal asymptotes.*

The domain of f is all x -values such that $4 - x^2 > 0$; the domain is thus $(-2, 2)$. So there are candidate vertical asymptotes at $x = -2$ and $x = 2$. Since $x = -2$ is the left endpoint of the domain, it makes sense only to compute the one-sided limit $x \rightarrow -2^+$.

$$\lim_{x \rightarrow -2^+} \ln(4 - x^2) = \lim_{x \rightarrow -2^+} (\ln(2 - x) + \ln(2 + x)) = \ln(4) + \lim_{x \rightarrow -2^+} \ln(2 + x)$$

Now we use the fact that

$$\lim_{x \rightarrow 0^+} \ln(x) = -\infty$$

Note that as $x \rightarrow -2^+$, this is the same as $2 + x \rightarrow 0^+$. So now we have

$$\lim_{x \rightarrow -2^+} \ln(2 + x) = \lim_{u \rightarrow 0^+} \ln(u) = -\infty$$

This implies that

$$\lim_{x \rightarrow -2^+} \ln(4 - x^2) = -\infty$$

By a similar calculation, we find that

$$\lim_{x \rightarrow 2^-} \ln(4 - x^2) = -\infty$$

(Again, note that since $x = 2$ is the right endpoint of the domain, it makes sense only to take the limit $x \rightarrow 2^-$.) Hence the vertical asymptotes are the lines $x = -2$ and $x = 2$.

Since the domain of f is bounded, it makes no sense to compute the limit of f as $x \rightarrow \pm\infty$, so there are no horizontal asymptotes.

(ii) *Intervals of increase and local extrema.*

Since f is differentiable on its domain, the only first-order critical numbers are solutions to $f'(x) = 0$.

$$\frac{-2x}{4 - x^2} = 0 \implies x = 0$$

(iii) *Intervals of concavity and inflection points.*

We make a sign chart for $f'(x)$.

interval	test point	sign	shape
$(-2, 0)$	$f'(-1) = \frac{\oplus}{\oplus}$	\oplus	increasing
$(0, 2)$	$f'(1) = \frac{\ominus}{\oplus}$	\ominus	decreasing

(iv) *Sketch of graph.*

There is a local maximum at $(0, \ln(4))$ and no local minimum.

Since f is twice-differentiable on its domain, the only second-order critical numbers are solutions to $f''(x) = 0$.

$$\frac{-2(x^2 + 4)}{(x^2 - 4)^2} = 0 \implies \text{no solution}$$

We make a sign chart for $f''(x)$.

interval	test point	sign	shape
$(-2, 2)$	$f''(0) = \frac{-2\oplus}{\oplus}$	\ominus	concave down

There are no points of inflection.

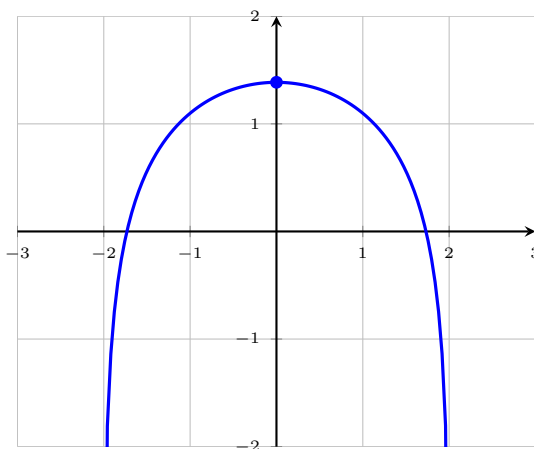

(i) The derivatives of f are

$$f'(x) = 5x^2(6 - x^2) \quad , \quad f''(x) = 20x(3 - x^2)$$

(i) *Vertical asymptotes and horizontal asymptotes.*

Since f is a polynomial, there are no asymptotes.

(ii) *Intervals of increase and local extrema.*

Since f is differentiable everywhere, the only first-order critical numbers are solutions to $f'(x) = 0$.

$$5x^2(6 - x^2) = 0 \implies x = 0 \text{ or } x = -\sqrt{6} \text{ or } x = \sqrt{6}$$

(iii) *Intervals of concavity and inflection points.*

We make a sign chart for $f'(x)$.

interval	test point	sign	shape
$(-\infty, -\sqrt{6})$	$f'(-3) = \oplus\ominus$	\ominus	decreasing
$(-\sqrt{6}, 0)$	$f'(-1) = \oplus\oplus$	\oplus	increasing
$(0, \sqrt{6})$	$f'(1) = \oplus\oplus$	\oplus	increasing
$(\sqrt{6}, \infty)$	$f'(3) = \oplus\ominus$	\ominus	decreasing

(iv) *Sketch of graph.*

There is a local maximum at $(\sqrt{6}, 24\sqrt{6})$ and a local minimum at $(-\sqrt{6}, -24\sqrt{6})$.

Since f is twice-differentiable everywhere, the only second-order critical numbers are solutions to $f''(x) = 0$.

$$20x(3 - x^2) = 0 \implies x = 0 \text{ or } x = -\sqrt{3} \text{ or } x = \sqrt{3}$$

We make a sign chart for $f''(x)$.

interval	test point	sign	shape
$(-\infty, -\sqrt{3})$	$f''(-3) = \ominus\ominus$	\oplus	concave up
$(-\sqrt{3}, 0)$	$f''(-1) = \ominus\oplus$	\ominus	concave down
$(0, \sqrt{3})$	$f''(1) = \oplus\oplus$	\oplus	concave up
$(\sqrt{3}, \infty)$	$f''(3) = \oplus\ominus$	\ominus	concave down

There are points of inflection at $(-\sqrt{3}, 21\sqrt{3})$, $(0, 0)$, and $(\sqrt{3}, 21\sqrt{3})$.

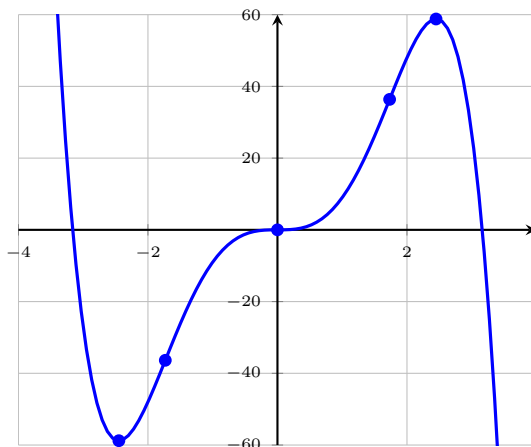

(j) The derivatives of f are

$$f'(x) = \frac{-3x^2}{(x^3 + 8)^2} \quad , \quad f''(x) = \frac{12x(x^3 - 4)}{(x^3 + 8)^3}$$

(i) *Vertical asymptotes and horizontal asymptotes.*

Observe that f is continuous on its domain, but is undefined for $x = -2$. Hence our candidate vertical asymptote is the line $x = -2$. Indeed, direct substitution of $x = -2$ into f gives the expression $\frac{1}{0}$, which indicates that both one-sided limits are infinite. We need only perform a sign analysis to determine the sign of infinity.

$$\lim_{x \rightarrow -2^-} \left(\frac{1}{x^3 + 8} \right) = \frac{1}{0^-} = -\infty$$

Note that we have used that fact that if $x \rightarrow -2^-$, then $x^3 + 8$ approaches 0 but remains negative. Similarly, we have

$$\lim_{x \rightarrow -2^+} \left(\frac{1}{x^3 + 8} \right) = \frac{1}{0^+} = \infty$$

Hence the line $x = -2$ is a true vertical asymptote.

As for the horizontal asymptotes we have the following.

$$\lim_{x \rightarrow \pm\infty} \left(\frac{1}{x^3 + 8} \right) = \frac{1}{\pm\infty} = 0$$

Hence the only horizontal asymptote is the line $y = 0$.

(ii) *Intervals of increase and local extrema.*

Since f is differentiable on its domain, the only first-order critical numbers are solutions to $f'(x) = 0$.

$$\frac{-3x^2}{(x^3 + 8)^2} = 0 \implies x = 0$$

(iii) *Intervals of concavity and inflection points.*

We make a sign chart for $f'(x)$.

interval	test point	sign	shape
$(-\infty, -2)$	$f'(-3) = \frac{\ominus}{\oplus}$	\ominus	decreasing
$(-2, 0)$	$f'(-1) = \frac{\ominus}{\oplus}$	\ominus	decreasing
$(0, \infty)$	$f'(1) = \frac{\ominus}{\oplus}$	\ominus	decreasing

(iv) *Sketch of graph.*

There are no local extrema.

Since f is twice-differentiable on its domain, the only second-order critical numbers are solutions to $f''(x) = 0$.

$$\frac{12x(x^3 - 4)}{(x^3 + 8)^3} = 0 \implies x = 0 \text{ or } x = 4^{1/3}$$

We make a sign chart for $f''(x)$.

interval	test point	sign	shape
$(-\infty, -2)$	$f''(-3) = \frac{\ominus\ominus}{\oplus}$	\oplus	concave down
$(-2, 0)$	$f''(-1) = \frac{\oplus\oplus}{\oplus}$	\oplus	concave up
$(0, 4^{1/3})$	$f''(1) = \frac{\oplus\ominus}{\oplus}$	\ominus	concave down
$(4^{1/3}, \infty)$	$f''(2) = \frac{\oplus\oplus}{\oplus}$	\oplus	concave up

There are points of inflection at $(0, \frac{1}{8})$ and $(4^{1/3}, \frac{1}{12})$.

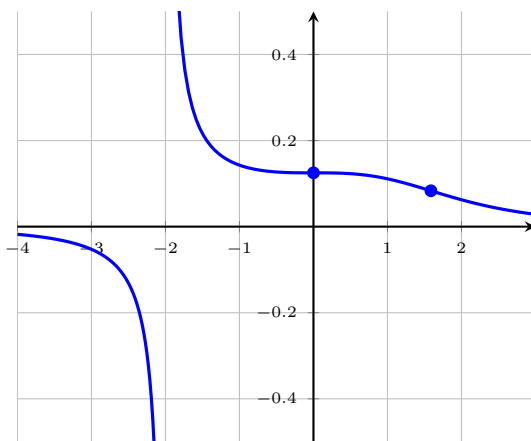

(k) The derivatives of f are

$$f'(x) = \frac{x^2(2x-3)}{(x-1)^2}, \quad f''(x) = \frac{2x(x^2-3x+3)}{(x-1)^3}$$

(i) *Vertical asymptotes and horizontal asymptotes.*

Observe that f is continuous on its domain, but is undefined for $x = 1$. Hence our candidate vertical asymptote is the line $x = 1$. Indeed, direct substitution of $x = 1$ into f gives the expression $\frac{1}{0}$, which indicates that both one-sided limits are infinite. We need only perform a sign analysis to determine the sign of infinity.

$$\lim_{x \rightarrow 1^-} \left(\frac{x^3}{x-1} \right) = \frac{1}{0^-} = -\infty$$

Note that we have used that fact that if $x \rightarrow 1^-$, then $x - 1$ approaches 0 but remains negative. Similarly, we have

$$\lim_{x \rightarrow 1^+} \left(\frac{x^3}{x-1} \right) = \frac{1}{0^+} = \infty$$

Hence the line $x = 1$ is a true vertical asymptote.

As for the horizontal asymptotes we have the following.

$$\lim_{x \rightarrow \pm\infty} \left(\frac{x^3}{x-1} \right) \stackrel{H}{=} \lim_{x \rightarrow \pm\infty} \left(\frac{3x^2}{1} \right) = \infty$$

So there is no horizontal asymptote.

(ii) *Intervals of increase and local extrema.*

Since f is differentiable on its domain, the only first-order critical numbers are solutions to $f'(x) = 0$.

$$\frac{x^2(2x-3)}{(x-1)^2} = 0 \implies x = 0 \text{ or } x = \frac{3}{2}$$

(iii) *Intervals of concavity and inflection points.*

We make a sign chart for $f'(x)$.

interval	test point	sign	shape
$(-\infty, 0)$	$f'(-1) = \frac{\oplus\ominus}{\oplus}$	\ominus	decreasing
$(0, 1)$	$f'(0.5) = \frac{\oplus\ominus}{\oplus}$	\ominus	decreasing
$(1, 1.5)$	$f'(1.25) = \frac{\oplus\ominus}{\oplus}$	\ominus	decreasing
$(1.5, \infty)$	$f'(2) = \frac{\oplus\oplus}{\oplus}$	\oplus	increasing

(iv) *Sketch of graph.*

There is a local maximum at $(1.5, 6.75)$ and no local minimum.

Since f is twice-differentiable on its domain, the only second-order critical numbers are solutions to $f''(x) = 0$.

$$\frac{2x(x^2 - 3x + 3)}{(x - 1)^3} = 0 \implies x = 0$$

Note: The quadratic $x^2 - 3x + 3$ has discriminant $\Delta = (-3)^2 - 4(1)(3) = -3 < 0$, and so $x^2 - 3x + 3 = 0$ has no solution. Since $x^2 - 3x + 3$ passes through the point $(0, 3)$, we see that $x^2 - 3x + 3 > 0$ for all x . We make a sign chart for $f''(x)$.

interval	test point	sign	shape
$(-\infty, 0)$	$f''(-1) = \frac{\ominus\oplus}{\ominus}$	\oplus	concave up
$(0, 1)$	$f''(0.5) = \frac{\oplus\oplus}{\ominus}$	\ominus	concave down
$(1, \infty)$	$f''(2) = \frac{\oplus\oplus}{\oplus}$	\oplus	concave up

There is an inflection point at $(0, 0)$.

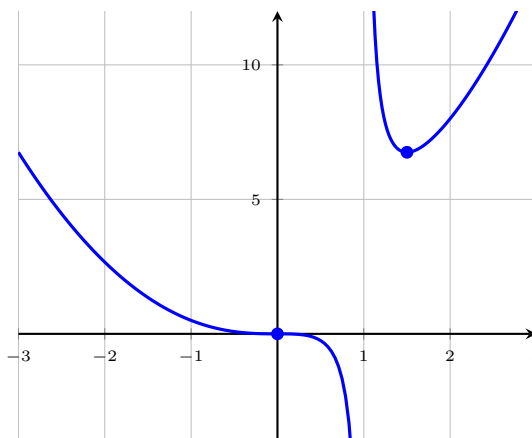

(l) The derivatives of f are

$$f'(x) = \frac{3(1-x^2)}{(x^3-3x)^2}, \quad f''(x) = \frac{6(2x^4-3x^2+3)}{(x^3-3x)^3}$$

(i) *Vertical asymptotes and horizontal asymptotes.*

Observe that f is continuous on its domain, but is undefined if $x^3 - 3x = 0$, or for $x = -\sqrt{3}$, $x = 0$, and $x = \sqrt{3}$. Hence our candidate vertical asymptotes are the lines $x = -\sqrt{3}$, $x = 0$, and $x = \sqrt{3}$. Indeed, direct substitution of any of these x -values into f gives the expression $\frac{1}{0}$, which indicates that both one-sided limits for each x -value are infinite. Hence all three lines $x = -\sqrt{3}$, $x = 0$, and $x = \sqrt{3}$ are true vertical asymptotes.

As for the horizontal asymptotes we have the following.

$$\lim_{x \rightarrow \pm\infty} \left(\frac{1}{x^3 - 3x} \right) = \frac{1}{\infty} = 0$$

Hence the only horizontal asymptote is the line $y = 0$.

(ii) *Intervals of increase and local extrema.*

Since f is differentiable on its domain, the only first-order critical numbers are solutions to $f'(x) = 0$.

$$\frac{3(1-x^2)}{(x^3-3x)^2} = 0 \implies x = -1 \text{ or } x = 1$$

(iii) *Intervals of concavity and inflection points.*

We make a sign chart for $f'(x)$.

interval	test point	sign	shape
$(-\infty, -\sqrt{3})$	$f'(-2) = \frac{\ominus}{\oplus}$	\ominus	decreasing
$(-\sqrt{3}, -1)$	$f'(-1.5) = \frac{\ominus}{\oplus}$	\ominus	decreasing
$(-1, 0)$	$f'(-0.5) = \frac{\oplus}{\oplus}$	\ominus	increasing
$(0, 1)$	$f'(0.5) = \frac{\oplus}{\oplus}$	\ominus	increasing
$(1, \sqrt{3})$	$f'(1.5) = \frac{\ominus}{\oplus}$	\oplus	decreasing
$(\sqrt{3}, \infty)$	$f'(2) = \frac{\ominus}{\oplus}$	\ominus	decreasing

(iv) *Sketch of graph.*

There is a local maximum at $(1, -\frac{1}{2})$ and a local minimum at $(-1, \frac{1}{2})$.

Since f is twice-differentiable on its domain, the only second-order critical numbers are solutions to $f''(x) = 0$.

$$\frac{6(2x^4 - 3x^2 + 3)}{(x^3 - 3x)^3} = 0 \implies \text{no solution}$$

Note: To solve the equation $2x^4 - 3x^2 + 3 = 0$, we let $u = x^2$ and write the equation as $2u^2 - 3u + 3 = 0$. The discriminant of this quadratic is $\Delta = (-3)^2 - 4(2)(3) = -15 < 0$, and so there are no values of u that satisfy the equation, and hence no values of x that satisfy $2x^4 - 3x^2 + 3 = 0$. Since the graph of $y = 2x^4 - 3x^2 + 3$ passes through $(0, 3)$, we see that $2x^4 - 3x^2 + 3 > 0$ for all x . We make a sign chart for $f''(x)$.

interval	test point	sign	shape
$(-\infty, -\sqrt{3})$	$f''(-2) = \frac{\oplus}{\ominus}$	\ominus	concave down
$(-\sqrt{3}, 0)$	$f''(-1) = \frac{\oplus}{\oplus}$	\oplus	concave up
$(0, \sqrt{3})$	$f''(1) = \frac{\oplus}{\ominus}$	\ominus	concave down
$(\sqrt{3}, \infty)$	$f''(2) = \frac{\oplus}{\oplus}$	\oplus	concave up

There are no inflection points.

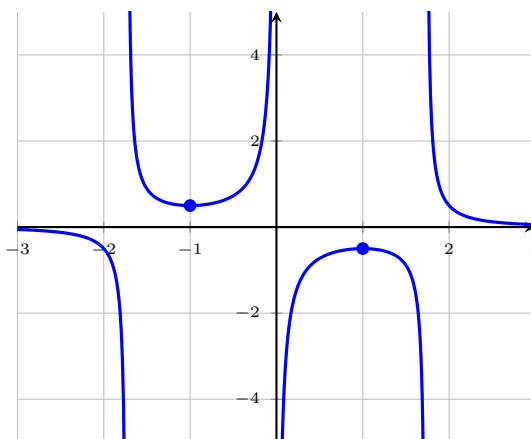

W74. Sketch the graph of a function f that satisfies all of the following conditions.

- $f'(x) > 0$ when $x < 2$ and when $2 < x < 5$
- $f'(x) < 0$ when $x > 5$
- $f'(2) = 0$
- $f''(x) < 0$ when $x < 2$ and when $4 < x < 7$
- $f''(x) > 0$ when $2 < x < 4$ and when $x > 7$

Solution

There are many possible solutions. Here is one.

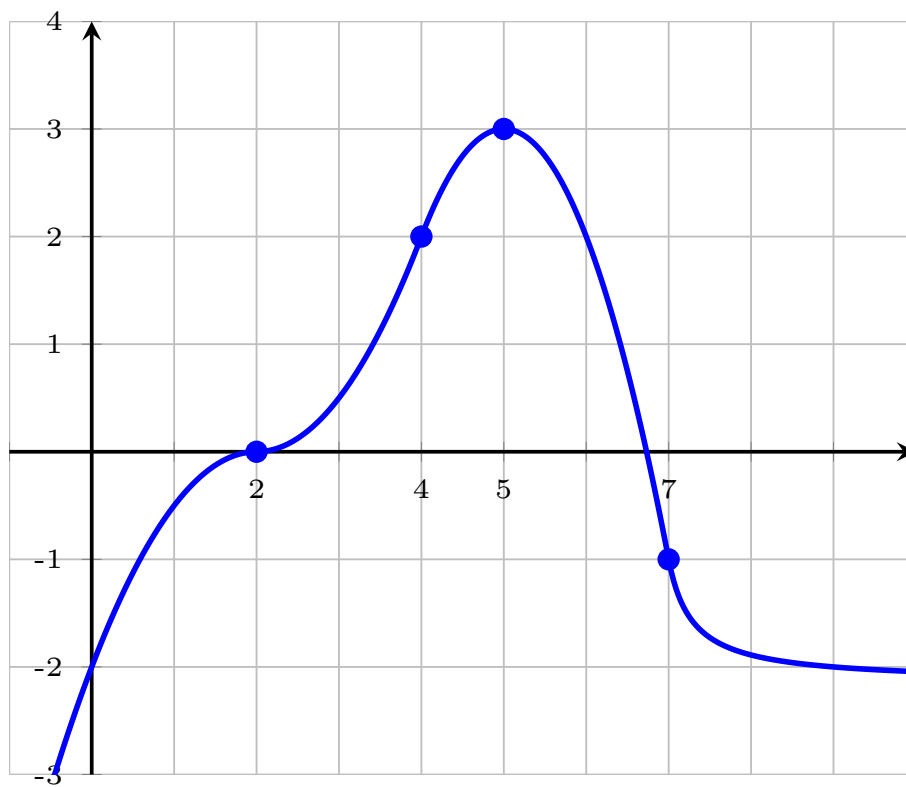

W75. Sketch the graph of a function f that satisfies all of the following conditions.

- the lines $y = 1$ and $x = 3$ are asymptotes
- f is increasing for $x < 3$ and $3 < x < 5$, and f is decreasing elsewhere
- the graph of $y = f(x)$ is concave up for $x < 3$ and for $x > 7$
- the graph of $y = f(x)$ is concave down for $3 < x < 7$
- $f(0) = f(5) = 4$ and $f(7) = 2$

Solution

There are many possible solutions. Here is one.

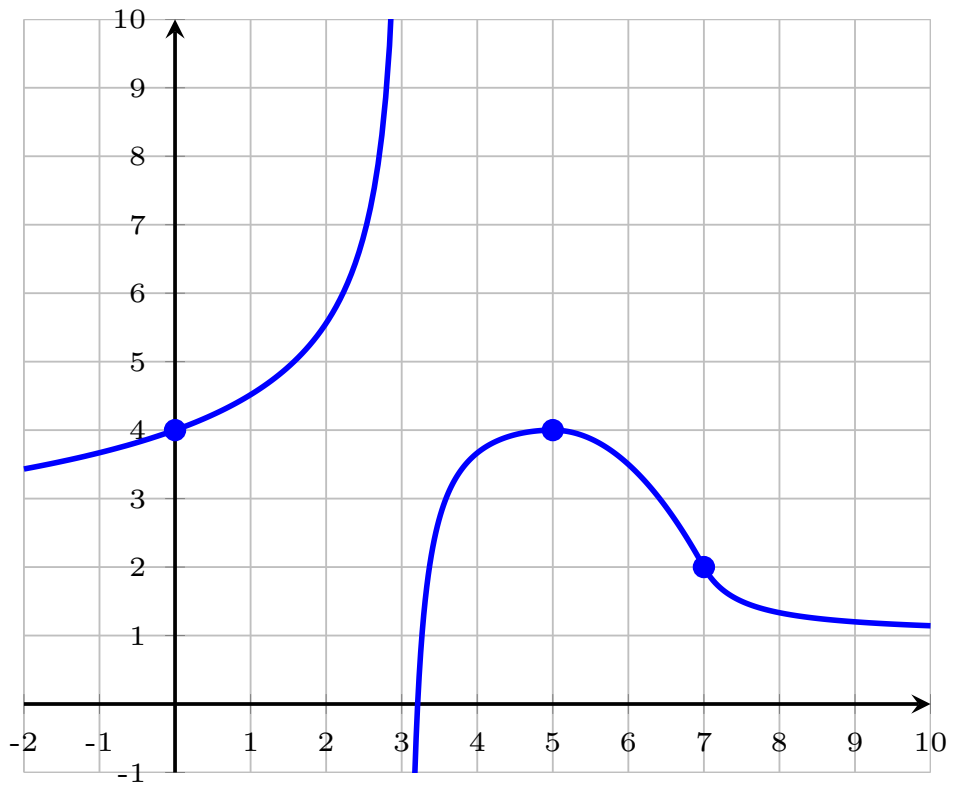

§4.5: Optimization Problems

Difficulty guide for this worksheet:

Core or Beyond Core: 76, 77, 78, 79, 80, 81, 84, 85, 86, 88, 89

Advanced: 82, 83, 87

Removed from syllabus: none

W76. The sum of two numbers is 80. Find the largest possible product.

Solution

We want to maximize $P(x, y) = xy$ subject to the constraint $x + y = 80$. Hence $y = 80 - x$, and we have to maximize the function

$$P(x) = x(80 - x) = 80x - x^2$$

on the interval $(-\infty, \infty)$. Since P is differentiable everywhere, the only critical numbers are solutions to $P'(x) = 0$.

$$P'(x) = 80 - 2x = 0 \implies x = 40$$

Now observe that $P''(x) = -2$, which is negative for all x . This means the graph of $P(x)$ is concave down on the interval $(-\infty, \infty)$. Hence $x = 40$ gives the global maximum of P .

The maximum product is $P(40) = 1600$.

W77. The sum of two numbers is 10. Find the smallest possible value for the sum of their squares.

Solution

We want to minimize $S(x, y) = x^2 + y^2$ subject to the constraint $x + y = 10$. Hence $y = 10 - x$, and we have to minimize the function

$$S(x) = x^2 + (10 - x)^2$$

on the interval $(-\infty, \infty)$. Since S is differentiable everywhere, the only critical numbers are solutions to $S'(x) = 0$.

$$S'(x) = 2x - 2(10 - x) = 0 \implies 4x - 20 = 0 \implies x = 5$$

Now observe that $S''(x) = 4$, which is positive for all x . This means the graph of $S(x)$ is concave up on the interval $(-\infty, \infty)$. Hence $x = 5$ gives the global minimum of S .

The minimum sum of squares is $S(5) = 50$.

W78. Find the dimensions of the rectangle of largest area that can be inscribed in a semicircle of radius 4, assuming that one side of the rectangle lies on the diameter of the semicircle.

Solution

Let x be the half-length of the rectangle and let y be the height. Then we want to maximize the function $A(x, y) = 2xy$. See the figure below.

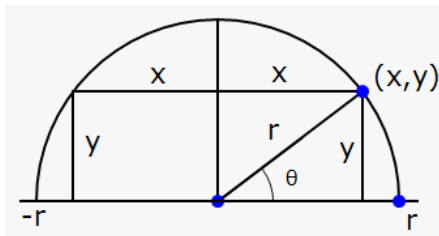

By Pythagorean theorem, $x^2 + y^2 = r^2$ (with $r = 4$), whence $y = \sqrt{16 - x^2}$. So we want to maximize the function

$$A(x) = 2x\sqrt{16 - x^2}$$

on the interval $[0, 4]$. Since A is differentiable on $(0, 4)$, the only critical numbers are the endpoints $x = 0$ and $x = 4$, and solutions to $A'(x) = 0$.

$$A'(x) = 2x \cdot \frac{-2x}{2\sqrt{16 - x^2}} + 2\sqrt{16 - x^2} = \frac{32 - 4x^2}{\sqrt{16 - x^2}} = 0 \implies x = \sqrt{8}$$

We now use the closed bounded interval test to verify $x = \sqrt{8}$ gives the maximum. Observe that $A(0) = A(4) = 0$ and $A(\sqrt{8})$ is clearly a positive number. Hence the maximum of A occurs at $x = \sqrt{8}$.

The dimensions of the rectangle of maximum area are $2\sqrt{8}$ (length) by $\sqrt{8}$ (height).

W79. Find the dimensions of the rectangle of largest area whose lower vertices lie on the x -axis and whose upper vertices lie on the graph of $y = e^{-x^2}$.

Solution

Let x be the half-length of the rectangle and let y be the height. (This means the upper left vertex has coordinates $(-x, y)$ and the upper right vertex has coordinates (x, y) .) Then we want to maximize the function $A(x, y) = 2xy$. Since the upper vertices of the rectangle lie on the given graph, we must have $y = e^{-x^2}$. Hence we want to maximize the function

$$A(x) = 2xe^{-x^2}$$

on the interval $[0, \infty)$. Since A is differentiable everywhere, the only critical numbers are the endpoint $x = 0$ and solutions to $A'(x) = 0$.

$$A'(x) = 2xe^{-x^2}(-2x) + 2e^{-x^2} = 2e^{-x^2}(1 - 2x^2) = 0 \implies x = \frac{1}{\sqrt{2}}$$

We will use first derivative test to verify we have found the x -value that gives the maximum. Note that $A'(0) = 2 > 0$ and $A'(1) = -\frac{2}{e} < 0$. Hence $A(x)$ is increasing on $[0, \frac{1}{\sqrt{2}})$ and decreasing on $(\frac{1}{\sqrt{2}}, \infty)$. Hence $A(x)$ has a global maximum at $x = \frac{1}{\sqrt{2}}$ on the interval $[0, \infty)$.

The dimensions of the rectangle of maximum area are $\sqrt{2}$ (length) by $\frac{1}{\sqrt{e}}$ (height).

W80. A farmer is constructing a rectangular fence on a straight river. The side of the rectangle bordering the river does not need any fencing. If the farmer has 1000 feet of fencing, what is the largest possible area he may enclose?

Solution

Let x be the length of the plot perpendicular to the river and let y be the length parallel to the river. We want to maximize the function $A(x, y) = xy$. See the figure below.

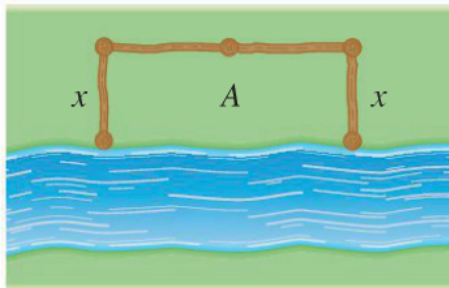

We must maximize the area subject to the constraint $2x + y = 1000$, whence $y = 1000 - 2x$. So we want to maximize the function

$$A(x) = x(1000 - 2x) = 1000x - 2x^2$$

on the interval $[0, \infty)$. Since A is differentiable on $(0, \infty)$, the only critical numbers are the endpoint $x = 0$ and solutions to $A'(x) = 0$.

$$A'(x) = 1000 - 4x = 0 \implies x = 250$$

Now observe that $A''(x) = -4$, which is negative for all x . Hence $x = 250$ gives a global maximum of $A(x)$ on the interval $[0, \infty)$.

The maximum possible area is $A(250) = 125,000 \text{ ft}^2$.

- W81.** A farmer with 1600 feet of fencing wants to enclose a rectangular area and then divide it into four equal-area pens with fencing parallel to one side of the rectangle. What is the largest possible area that a single pen can enclose?

Solution

Let x be the length of each pen (so the length of the entire enclosure is $4x$) and let y be the width of each pen (the widths are parallel to each other, so the width of the entire enclosure is also y). We want to maximize the function $A(x, y) = xy$. See the figure below.

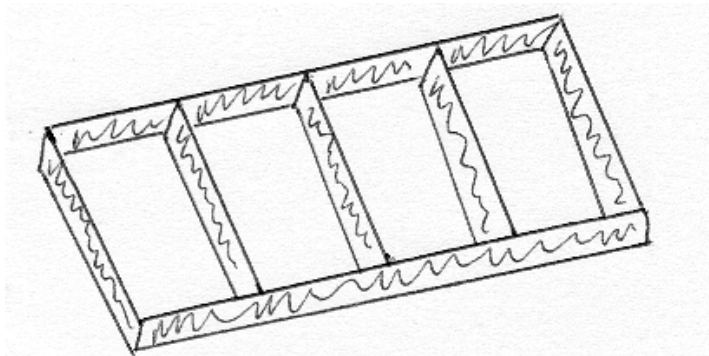

We must maximize the area subject to the constraint $8x + 5y = 1600$, whence $y = \frac{1}{5}(1600 - 8x)$. So we want to maximize the function

$$A(x) = x \cdot \frac{1}{5}(1600 - 8x) = \frac{1}{5}(1600x - 8x^2)$$

on the interval $[0, 200]$. (These endpoints correspond, respectively, to the degenerate cases $x = 0$ and $y = 0$.) Since A is differentiable on $(0, 200)$ the only critical numbers are the endpoints $x = 0$ and $x = 200$ and solutions to $A'(x) = 0$.

$$A'(x) = \frac{1}{5}(1600 - 16x) = 0 \implies x = 100$$

We now use the closed bounded interval test to verify $x = 100$ gives the maximum. Observe that $A(0) = A(200) = 0$ and $A(100)$ is clearly a positive number. Hence the maximum of A occurs at $x = 100$.

The maximum area of a single pen is $A(100) = 16,000 \text{ ft}^2$.

- W82.** A truck is 250 miles east of a sports car and is traveling west at a constant speed of 60 miles per hour. Meanwhile, the sports car is going north at 80 miles per hour. When will the truck and car be closest to each other? What is the minimum distance between them?

Solution

We consider a coordinate system in which the sports car is initially at the origin. The truck travels along the x -axis, whence the coordinates of its position are $(x(t), 0)$. We know that $x(0) = 250$ and $\frac{dx}{dt} = -60$ for all t . Hence $x(t) = 250 - 60t$. The car travels along the y -axis, whence the coordinates of its position are $(0, y(t))$. We know that $y(0) = 0$ and $\frac{dy}{dt} = 80$ for all t . Hence $y(t) = 80t$. In summary, the coordinates of each vehicle at time t are given by

$$\begin{aligned} \text{truck} & : T = (250 - 60t, 0) \\ \text{car} & : C = (0, 80t) \end{aligned}$$

The distance D between the car and truck at time t is thus

$$D(t) = \sqrt{(250 - 60t)^2 + (80t)^2}$$

We want to minimize $D(t)$ on the interval $[0, \infty)$. Since D is differentiable everywhere, the only critical numbers of D are the endpoint $t = 0$ and solutions to $D'(t) = 0$.

$$D'(t) = \frac{2(250 - 60t)(-60) + 2(80t)(80)}{2\sqrt{(250 - 60t)^2 + (80t)^2}} = \frac{10,000t - 15,000}{\sqrt{(250 - 60t)^2 + (80t)^2}} = 0 \implies t = 1.5$$

We will use first derivative test to verify we have found the t -value that gives the minimum. Note that $D'(0) = \frac{\ominus}{\oplus} < 0$ and $D'(2) = \frac{\oplus}{\oplus} > 0$. Hence $D(t)$ is decreasing on $[0, 1.5)$ and increasing on $(1.5, \infty)$. Hence $D(t)$ has a global minimum at $t = 1.5$ on the interval $[0, \infty)$.

The truck and car are closest to each other 1.5 hours later, and their minimum separation is $D(1.5) = 200$ miles.

- W83.** Suppose we want to construct a rectangular aquarium that must hold a volume of 4000 in^3 . The length of the base will be twice the width of the base. The top and bottom bases of the tank cost $\$1.50/\text{in}^2$. Each of the sides of the tank costs $\$3/\text{in}^2$. Find the dimensions (length, width, height) of the cheapest tank.

Solution

Let ℓ , w , and h denote the length, width, and height of the aquarium. The cost of the top and bottom bases is $1.5(2\ell w) = 3\ell w$. The cost of the sides is $3(2\ell h + 2wh) = 6h(\ell + w)$. So we want to minimize the total cost function

$$C(\ell, w, h) = 3\ell w + 6h(\ell + w)$$

One constraint is that $\ell = 2w$, and the second constraint is that $\ell wh = 4000$. Substituting $\ell = 2w$ into the volume constraint and solving for h gives $h = \frac{2000}{w^2}$. Now writing ℓ and h in terms of w in the cost function shows that we have to minimize the function

$$C(w) = 6w^2 + \frac{36,000}{w}$$

on the interval $(0, \infty)$. Since C is differentiable on $(0, \infty)$, the only critical numbers are solutions to $C'(w) = 0$.

$$C'(w) = 12w - \frac{36,000}{w^2} = 0 \implies w = \sqrt[3]{3000} = 10\sqrt[3]{3}$$

Now observe that $C''(w) = 12 + \frac{72,000}{w^3}$, which is positive for all w in $(0, \infty)$. This means the graph of $S(w)$ is concave up on the interval $(0, \infty)$. Hence $w = 10\sqrt[3]{3}$ gives the global minimum of C . The dimensions of the cheapest tank are $\ell = 20\sqrt[3]{3}$ in. (length), $w = 10\sqrt[3]{3}$ in. (width), and $h = \frac{20}{\sqrt[3]{9}}$ in. (height).

W84. The total cost of producing x widgets is

$$C(x) = x^3 + 9x^2 + 18x + 200$$

and the selling price per unit is

$$p(x) = 45 - 2x^2$$

What is the optimal price? (That is, what price maximizes total profit?)

Solution

The total revenue is $R(x) = xp(x) = 45x - 2x^3$. Thus the marginal cost and marginal revenue are

$$MC(x) = 3x^2 + 18x + 18$$

$$MR(x) = 45 - 6x^2$$

Profit is maximized when $MC = MR$.

$$3x^2 + 18x + 18 = 45 - 6x^2$$

$$9x^2 + 18x - 27 = 0$$

$$9(x+3)(x-1) = 0$$

The only solution is $x = 1$ (production cannot be negative). Thus the optimal price is $p(1) = 43$. (Verification that $x = 1$ gives maximum profit is not required for cost-revenue problems.)

W85. Suppose the total cost of producing x units is

$$C(x) = 2x^4 - 10x^3 - 18x^2 + x + 5$$

Find the smallest and largest values of marginal cost for $0 \leq x \leq 5$.

Solution

The marginal cost is

$$MC(x) = 8x^3 - 30x^2 - 36x + 1$$

To find the local extrema of $MC(x)$, we find the critical numbers of $MC(x)$. Since $MC(x)$ is a polynomial (and hence differentiable for all x), the only critical numbers are solutions to the equation $MC'(x) = 0$.

$$0 = MC'(x) = 24x^2 - 60x - 36 = 12(2x + 1)(x - 3) \implies x = 3$$

The minimum and maximum of $MC'(x)$ on the interval $[0, 5]$ must occur at either $x = 3$ or the endpoints.

$$MC(x) = 8x^3 - 30x^2 - 36x + 1 = (4x - 15)(2x^2 - 9) - 134$$

$$MC(0) = 1$$

$$MC(3) = -161$$

$$MC(5) = 71$$

Hence the minimum marginal cost is -161 and the maximum marginal cost is 71 .

W86. Suppose the total cost of manufacturing x widgets is

$$C(x) = 3x^2 + 5x + 75$$

What level of production minimizes the average cost per unit?

Solution

The average cost per unit is

$$AC(x) = \frac{C(x)}{x} = 3x + 5 + \frac{75}{x}$$

To minimize the average cost on the interval $(0, \infty)$, we find the critical numbers. Since $AC(x)$ is differentiable on $(0, \infty)$, the critical numbers are solutions to $AC'(x) = 0$.

$$0 = AC'(x) = 3 - \frac{75}{x^2} \implies x = 5$$

Now observe that $AC''(x) = \frac{150}{x^3} > 0$ for all $x > 0$. Hence the graph of $AC(x)$ is concave up on $(0, \infty)$, whence $x = 5$ gives the global minimum of $AC(x)$.

W87. A tour agency is booking a tour and has 100 people signed up. The price of a ticket is \$2000 per person. The agency has booked a plane seating 150 people at a cost of \$125,000. Additional costs to the agency are incidental fees of \$500 per person. For each \$10 that the price is lowered, a new person will sign up. How much should the price be lowered for all participants to maximize the profit to the tour agency?

Solution

Let x be the number of people signed up and let p be the price of a ticket. Then p is a linear function of x (note the phrase “for each” in the problem). We know that $p = 2000$ if $x = 100$ and that $\Delta x = 1$ if $\Delta p = -10$. This means if we write $p(x) = p_0 + m(x - x_0)$, we have the point $(x_0, p_0) = (100, 2000)$ and the slope $m = -10$. Hence

$$p(x) = 2000 - 10(x - 100) = 3000 - 10x$$

The total revenue and total cost for the agency are thus

$$\begin{aligned} R(x) &= xp(x) = 3000x - 10x^2 \\ C(x) &= 125000 + 500x \end{aligned}$$

The total profit is maximized when marginal cost is equal to marginal revenue.

$$MR = MC \implies 3000 - 20x = 500 \implies x = 125$$

Note that we are maximizing the profit on the interval $x \in [0, 150]$ since the plane holds at most 150 people. Since $x = 125$ is in the valid interval, $x = 125$ gives the maximum profit. (Cost-revenue problems do not require verification as long as the candidate level of production is in the valid interval.)

The optimal price is thus $p(125) = 3000 - 1250 = 1750$. So the price should be lowered by \$250.

W88. The total cost of producing x widgets is

$$C(x) = x^3 - 6x^2 + 15x$$

and the selling price per unit is fixed at $p(x) = 6$. Show that if you want to set a level of production to maximize total profit, the best you can do is break even.

Solution

The total revenue from selling x widgets is $R(x) = 6x$, and so the total profit is

$$P(x) = R(x) - C(x) = -9x + 6x^2 - x^3$$

If the profit P has a local maximum at x , then $P'(x) = 0$.

$$P'(x) = -9 + 12x - 3x^2 = -3(x - 1)(x - 3)$$

Solving $P'(x) = 0$ shows that the only candidate levels of production for maximum profit are $x = 1$ and $x = 3$. Note that $P(1) = -4$ (so we lose money if produce 1 unit) and $P(3) = 0$ (so we break even if we produce 3 units). Since $P(x) \rightarrow -\infty$ as $x \rightarrow \infty$ and $P(0) = 0$, we see that the maximum value of $P(x)$ on the interval $[0, \infty)$ is 0. So the best we can do is break even.

W89. The reaction of the body to a dose of medicine can sometimes be represented by an equation of the form

$$R = M^2 \left(\frac{C}{2} - \frac{M}{3} \right)$$

where C is a positive constant and M is the amount of medicine absorbed in the blood. If the reaction is a change in blood pressure, R is measure in millimeters of mercury. If the reaction is a change in temperature, R is measured in degrees, and so on.

The quantity $\frac{dR}{dM}$ is called the *sensitivity* of the body to the medicine. Find the amount of medicine to which the body is most sensitive.

Solution

First note that the sensitivity is

$$S(M) = \frac{dR}{dM} = M^2 \left(-\frac{1}{3}\right) + 2M \left(\frac{C}{2} - \frac{M}{3}\right) = CM - M^2$$

Our goal is to find the maximum value of $S(M)$. The maximum value must occur at a critical number, which, since S is differentiable for all M , a solution to the equation $S'(M) = 0$. Note that $S'(M) = C - 2M$, and so the only critical number is $M = C/2$. Observe that $S''(M) = -2 < 0$ for all M , and so $M = C/2$ does, indeed, give a global maximum. The body is most sensitive to medicine when $M = C/2$.

§4.6: Linear Approximation and Differentials

Difficulty guide for this worksheet:

Core or Beyond Core: 90, 91, 92

Advanced: none

Removed from syllabus: 93

W90. Use a linear approximation to estimate the value of each of the following.

You must express your answer as a single exact rational number.

(a) $e^{0.1}$

(c) $\frac{1}{\sqrt[3]{25}}$

(e) $\sqrt{96}$

(b) $\ln(1.04)$

(d) $(\sec(\frac{\pi}{4} - 0.02))^2$

(f) $(5.01)^3 - 2(5.01) + 3$

Solution

(a) Let $f(x) = e^x$. Our goal is to estimate $f(0.1)$ using the tangent line to $f(x)$ at $x = 0$.

$$f(0) = e^0 = 1$$

$$f'(x) = e^x$$

$$f'(0) = e^0 = 1$$

Hence an equation of the tangent line to $f(x)$ at $x = 0$ is

$$y = 1 + x$$

Substituting $x = 0.1$ into the tangent line gives the desired approximation.

$$e^{0.1} = f(0.1) \approx 1 + 0.1 = 1.1$$

(b) Let $f(x) = \ln(x)$. Our goal is to estimate $f(1.04)$ using the tangent line to $f(x)$ at $x = 1$.

$$f(1) = \ln(1) = 0$$

$$f'(x) = \frac{1}{x}$$

$$f'(1) = \frac{1}{1} = 1$$

Hence an equation of the tangent line to $f(x)$ at $x = 1$ is

$$y = x - 1$$

Substituting $x = 1.04$ into the tangent line gives the desired approximation.

$$\ln(1.04) = f(1.04) \approx 0.04$$

(c) Let $f(x) = x^{-1/3}$. Our goal is to estimate $f(25)$ using the tangent line to $f(x)$ at $x = 27$.

$$\begin{aligned} f(27) &= 27^{-1/3} = \frac{1}{3} \\ f'(x) &= -\frac{1}{3}x^{-4/3} \\ f'(27) &= -\frac{1}{3} \cdot 27^{-4/3} = -\frac{1}{3} \cdot \frac{1}{3^4} = -\frac{1}{243} \end{aligned}$$

Hence an equation of the tangent line to $f(x)$ at $x = 27$ is

$$y = \frac{1}{3} - \frac{1}{243}(x - 27)$$

Substituting $x = 25$ into the tangent line gives the desired approximation.

$$\frac{1}{\sqrt[3]{25}} = f(25) \approx \frac{1}{3} - \frac{1}{243}(-2) = \frac{81}{243} + \frac{2}{243} = \frac{83}{243}$$

(d) Let $f(x) = \sec(x)^2$. Our goal is to estimate $f\left(\frac{\pi}{4} - 0.02\right)$ using the tangent line to $f(x)$ at $x = \frac{\pi}{4}$.

$$\begin{aligned} f\left(\frac{\pi}{4}\right) &= \sec\left(\frac{\pi}{4}\right)^2 = (\sqrt{2})^2 = 2 \\ f'(x) &= 2 \sec(x) \cdot \sec(x) \tan(x) = 2 \sec(x)^2 \tan(x) \\ f'\left(\frac{\pi}{4}\right) &= 2 \sec\left(\frac{\pi}{4}\right)^2 \tan\left(\frac{\pi}{4}\right) = 2 \cdot 2 \cdot 1 = 4 \end{aligned}$$

Hence an equation of the tangent line to $f(x)$ at $x = \frac{\pi}{4}$ is

$$y = 2 + 4\left(x - \frac{\pi}{4}\right)$$

Substituting $x = \frac{\pi}{4} - 0.02$ into the tangent line gives the desired approximation.

$$\left(\sec\left(\frac{\pi}{4} - 0.02\right)\right)^2 = f\left(\frac{\pi}{4} - 0.02\right) \approx 2 + 4(-0.02) = 2 - 0.08 = 1.92$$

(e) Let $f(x) = \sqrt{x}$. Our goal is to estimate $f(96)$ using the tangent line to $f(x)$ at $x = 100$.

$$\begin{aligned} f(100) &= \sqrt{100} = 10 \\ f'(x) &= \frac{1}{2\sqrt{x}} \\ f'(100) &= \frac{1}{2\sqrt{100}} = \frac{1}{20} \end{aligned}$$

Hence an equation of the tangent line to $f(x)$ at $x = 100$ is

$$y = 10 + \frac{1}{20}(x - 100)$$

Substituting $x = 96$ into the tangent line gives the desired approximation.

$$f(96) \approx 10 + \frac{1}{20}(96 - 100) = 10 + \frac{-4}{20} = 9.8$$

- (f) Let $f(x) = x^3 - 2x + 3$. Our goal is to estimate $f(5.01)$ using the tangent line to $f(x)$ at $x = 5$.

$$f(5) = 5^3 - 2 \cdot 5 + 3 = 118$$

$$f'(x) = 3x^2 - 2$$

$$f'(5) = 3 \cdot 25 - 2 = 73$$

Hence an equation of the tangent line to $f(x)$ at $x = 5$ is

$$y = 118 + 73(x - 5)$$

Substituting $x = 5.01$ into the tangent line gives the desired approximation.

$$f(5.01) \approx 118 + 73(5.01 - 5) = 118.73$$

- W91.** A manufacturer's total cost (in dollars) when the level of production is q units is

$$C(q) = q^5 - 2q^3 + 3q^2 - 2$$

The current level of production is 3 units, and the manufacturer is planning to increase this to 3.01 units. Estimate how the total cost will change as a result.

Solution

The exact change in cost is

$$\Delta C = C(3.01) - C(3)$$

But using a linear approximation, this change can be estimated using the marginal cost.

$$\Delta C = C(3.01) - C(3) \approx C'(3) \cdot (0.01)$$

(Alternatively, $C(3.01)$ is estimated using the tangent line to $C(q)$ at $q = 3$.)

$$C'(q) = 5q^4 - 6q^2 + 6q$$

$$C'(3) = 5 \cdot 3^4 - 6 \cdot 3^2 + 6 \cdot 3 = 405 - 54 + 6 = 369$$

Hence our estimation of the change in cost is

$$\Delta C \approx (369)(0.01) = 3.69$$

The cost will increase by approximately 3.69 dollars.

- W92.** A manufacturer's total cost (in dollars) when the level of production is q units is

$$C(q) = 3q^2 + q + 500$$

- (a) What is the exact cost of manufacturing the 41st unit?
 (b) Use marginal analysis to estimate the cost of manufacturing the 41st unit.

Solution

(a) The exact cost is

$$\begin{aligned}\Delta C &= C(41) - C(40) = 3 \cdot (41^2 - 40^2) + (41 - 40) \\ &= 3(41 - 40)(41 + 40) + 1 = 3(81) + 1 = 244\end{aligned}$$

dollars.

(b) The exact cost of producing one more unit is estimated using the marginal cost. That is,

$$\Delta C = C(41) - C(40) \approx C'(40) \cdot 1$$

(Alternatively, $C(41)$ is estimated using the tangent line to $C(q)$ at $q = 40$.)

$$C'(q) = 6q + 1$$

$$C'(40) = 241$$

Hence our estimation of the cost of producing the 41st unit is

$$\Delta C \approx 241$$

dollars.

W93. You measure the radius of a sphere to be 6 inches, and then you use your measurement to calculate the volume of the sphere with the formula $V = \frac{4\pi}{3}r^3$. If your measurement of the radius is accurate to within 1%, approximately how accurate (to the nearest percent) is your calculation of the volume?

Solution

Let r_0 denote the measured radius and let V_0 denote the volume as calculated from the measured radius. (That is, $r_0 = 6$ and $V_0 = \frac{4\pi}{3}r_0^3 = 288\pi$ in this problem.) Let r and V denote the exact radius and volume of the sphere. (So $V = \frac{4\pi}{3}r^3$.)

Recall that the error between the measured volume and the exact volume is defined as

$$\Delta V = V - V_0$$

If we let $f(r) = \frac{4\pi}{3}r^3$, note that this error can be written as

$$\Delta V = f(r) - f(r_0)$$

Using a linear approximation (i.e., tangent line approximation), this error is estimated as

$$\Delta V \approx f'(r_0)\Delta r$$

where we have defined $\Delta r = r - r_0$, which is the error in the radius. Calculating the derivative gives

$$\Delta V \approx 4\pi r_0^2 \Delta r$$

We are interested in the relative error in the volume, which is $\frac{\Delta V}{V_0}$. So dividing our approximation by V gives the following.

$$\frac{\Delta V}{V_0} \approx \frac{4\pi r_0^2 \Delta r}{V_0} = \frac{4\pi r_0^2 \Delta r}{\frac{4\pi}{3}r_0^3} = 3 \frac{\Delta r}{r_0}$$

Observe that $\frac{\Delta r}{r_0}$ is the relative error in the radius (which is 1% for this problem). Hence we have found that the relative error in the volume is about 3 times as large as the relative error in the radius. So the relative error in the volume is about 3%.

§4.7: L'Hôpital's Rule

*Difficulty guide for this worksheet:**Core or Beyond Core:* 94 (all parts except e, g, k, m, and p)*Advanced:* 94e, 94g, 94k, 94m, 94p*Removed from syllabus:* none**W94.** For each part, calculate the limit or show that it does not exist. Show all work.*If you use L'Hospital's Rule, you must justify its use.*

- | | |
|--|--|
| (a) $\lim_{x \rightarrow 0} \left(\frac{e^{2x} - 1 - 2x - 2x^2}{x^3} \right)$ | (j) $\lim_{x \rightarrow 3} \left(\frac{\sqrt{x+1} - 2}{x^3 - 7x - 6} \right)$ |
| (b) $\lim_{x \rightarrow 1} \left(\frac{x^3 - 1}{x^4 - x} \right)$ | (k) $\lim_{x \rightarrow \infty} \left(\sqrt{x^2 + x} - x \right)$ |
| (c) $\lim_{x \rightarrow 2} \left(\frac{x^3 - 8}{x^4 - x} \right)$ | (l) $\lim_{x \rightarrow 0} \left(\frac{1}{\sin(x)} - \frac{1}{x} \right)$ |
| (d) $\lim_{x \rightarrow \infty} \left(\frac{x-1}{x+2} \right)$ | (m) $\lim_{x \rightarrow 0} (\cos(x))^{3/x^2}$ |
| (e) $\lim_{x \rightarrow \infty} \left(\frac{x-1}{x+2} \right)^x$ | (n) $\lim_{x \rightarrow \infty} \left(\frac{x}{\sqrt{3x^2 + 4}} \right)$ |
| (f) $\lim_{x \rightarrow \pi/2} \left(\frac{\sec(x)}{\tan(x)} \right)$ | (o) $\lim_{x \rightarrow \infty} \left(\frac{e^x - e^{-x}}{e^x + e^{-x}} \right)$ |
| (g) $\lim_{x \rightarrow 0^+} (\sin(2x) \ln(x))$ | (p) $\lim_{x \rightarrow 0} (1 - \sin(2x))^{1/\tan(3x)}$ |
| (h) $\lim_{x \rightarrow 0^+} (x^{-4} \ln(x))$ | (q) $\lim_{x \rightarrow 0} \left(\frac{x \sin(x)}{1 - \cos(x)} \right)$ |
| (i) $\lim_{x \rightarrow 4} \left(\frac{1}{\sqrt{x} - 2} - \frac{4}{x - 4} \right)$ | (r) $\lim_{x \rightarrow \pi/2} \left((x - \frac{\pi}{2}) \tan(x) \right)$ |

Solution

Recall that L'Hospital's Rule (LR) can be used only for indeterminate quotients of the form $\frac{0}{0}$ or $\frac{\infty}{\infty}$. With some algebra, we can transform indeterminate products ($0 \cdot \infty$), indeterminate exponents (1^∞ , 0^0 , or ∞^0), and indeterminate differences ($\infty - \infty$ or $-\infty + \infty$) into indeterminate quotients. We must justify use of LR by verifying which indeterminate form we have at each step. This verification will be shown at each step.

In all of the work below, the notation "H" will denote that LR has been used in that step. Consider the following expressions.

$$\lim_{x \rightarrow 0^+} \underbrace{(x \ln(x))}_{0 \cdot (-\infty)} = \lim_{x \rightarrow 0^+} \underbrace{\left(\frac{\ln(x)}{1/x} \right)}_{\frac{0}{0}} \stackrel{H}{=} \lim_{x \rightarrow 0^+} \left(\frac{1/x}{-1/x^2} \right) = \lim_{x \rightarrow 0^+} (-x) = 0$$

Note that the indeterminate form is noted at each step. LR is used in the second step only; all other steps follow from algebra or computing simple limits.

Note that not every problem will use L'Hospital's Rule.

(a) Standard applications of LR.

$$\begin{aligned} \lim_{x \rightarrow 0} \underbrace{\left(\frac{e^{2x} - 1 - 2x - 2x^2}{x^3} \right)}_{\frac{0}{0}} &\stackrel{H}{=} \lim_{x \rightarrow 0} \underbrace{\left(\frac{2e^{2x} - 2 - 4x}{3x^2} \right)}_{\frac{0}{0}} \stackrel{H}{=} \lim_{x \rightarrow 0} \underbrace{\left(\frac{4e^{2x} - 4}{6x} \right)}_{\frac{0}{0}} \\ &\stackrel{H}{=} \lim_{x \rightarrow 0} \left(\frac{8e^{2x}}{6} \right) = \frac{8}{6} \end{aligned}$$

(b) Factor and cancel.

$$\lim_{x \rightarrow 1} \left(\frac{x^3 - 1}{x^4 - x} \right) = \lim_{x \rightarrow 1} \left(\frac{x^3 - 1}{x(x^3 - 1)} \right) = \lim_{x \rightarrow 1} \left(\frac{1}{x} \right) = 1$$

(c) Direct substitution.

$$\lim_{x \rightarrow 2} \left(\frac{x^3 - 8}{x^4 - x} \right) = \frac{0}{14} = 0$$

(d) Standard application of LR.

$$\lim_{x \rightarrow \infty} \underbrace{\left(\frac{x-1}{x+2} \right)}_{\frac{\infty}{\infty}} \stackrel{H}{=} \lim_{x \rightarrow \infty} \left(\frac{1}{1} \right) = 1$$

(e) We use the result of part (d) to determine the indeterminate form.

$$\lim_{x \rightarrow \infty} \underbrace{\left(\frac{x-1}{x+2} \right)^x}_{1^\infty} := L$$

Now consider $\ln(L)$.

$$\begin{aligned} \ln(L) &= \lim_{x \rightarrow \infty} \underbrace{\left(x \ln \left(\frac{x-1}{x+2} \right) \right)}_{\infty \cdot 0} = \lim_{x \rightarrow \infty} \underbrace{\left(\frac{\ln \left(\frac{x-1}{x+2} \right)}{1/x} \right)}_{\frac{0}{0}} \\ &\stackrel{H}{=} \lim_{x \rightarrow \infty} \left(\frac{\frac{x+2}{x-1} \cdot \frac{(x+2) \cdot 1 - (x-1) \cdot 1}{(x+2)^2}}{-1/x^2} \right) = \lim_{x \rightarrow \infty} \left(\frac{-3x^2}{(x-1)(x+2)} \right) \\ &= \lim_{x \rightarrow \infty} \left(\frac{x^2}{x^2} \cdot \frac{-3}{\left(1 - \frac{1}{x}\right) \left(1 + \frac{2}{x}\right)} \right) = \lim_{x \rightarrow \infty} \left(\frac{-3}{\left(1 - \frac{1}{x}\right) \left(1 + \frac{2}{x}\right)} \right) \\ &= \frac{-3}{(1-0)(1+0)} = -3 \end{aligned}$$

Since $\ln(L) = -3$, it follows that $L = e^{-3}$.

(f) Simplify and cancel. (LR is applicable, but you will get caught in an endless loop.)

$$\lim_{x \rightarrow \pi/2} \left(\frac{\sec(x)}{\tan(x)} \right) = \lim_{x \rightarrow \pi/2} \left(\frac{1/\cos(x)}{\sin(x)/\cos(x)} \right) = \lim_{x \rightarrow \pi/2} \left(\frac{1}{\sin(x)} \right) = 1$$

(g) Write the product as a quotient, then use LR.

$$\begin{aligned}\lim_{x \rightarrow 0^+} \underbrace{(\sin(2x) \ln(x))}_{0 \cdot (-\infty)} &= \lim_{x \rightarrow 0^+} \underbrace{\left(\frac{\ln(x)}{\csc(2x)}\right)}_{\frac{-\infty}{\infty}} \stackrel{H}{=} \lim_{x \rightarrow 0^+} \left(\frac{1/x}{-2 \csc(2x) \cot(2x)}\right) \\ &= \lim_{x \rightarrow 0^+} \left(-\frac{\sin(2x)}{2x} \cdot \tan(2x)\right) = -1 \cdot 0 = 0\end{aligned}$$

(h) LR is not applicable here.

$$\lim_{x \rightarrow 0^+} (x^{-4} \ln(x)) = (+\infty)(-\infty) = -\infty$$

(i) Find a common denominator and fully simplify. No need for LR.

$$\begin{aligned}\lim_{x \rightarrow 4} \left(\frac{1}{\sqrt{x}-2} - \frac{4}{x-4}\right) &= \lim_{x \rightarrow 4} \left(\frac{\sqrt{x}+2}{x-4} - \frac{4}{x-4}\right) = \lim_{x \rightarrow 4} \left(\frac{\sqrt{x}-2}{x-4}\right) \\ &= \lim_{x \rightarrow 4} \left(\frac{x-4}{(x-4)(\sqrt{x}+2)}\right) = \lim_{x \rightarrow 4} \left(\frac{1}{\sqrt{x}+2}\right) \\ &= \frac{1}{2+2} = \frac{1}{4}\end{aligned}$$

(j) Standard application of LR.

$$\lim_{x \rightarrow 3} \underbrace{\left(\frac{\sqrt{x+1}-2}{x^3-7x-6}\right)}_{\frac{0}{0}} \stackrel{H}{=} \lim_{x \rightarrow 3} \left(\frac{\frac{1}{2\sqrt{x+1}}}{3x^2-7}\right) = \frac{\frac{1}{2 \cdot 2}}{3 \cdot 9 - 7} = \frac{1}{80}$$

(k) First determine the indeterminate exponent.

$$\lim_{x \rightarrow 0} \underbrace{(\cos(x))^{3/x^2}}_{1^\infty} := L$$

Now consider $\ln(L)$.

$$\begin{aligned}\ln(L) &= \lim_{x \rightarrow 0} \underbrace{\left(\frac{3 \ln(\cos(x))}{x^2}\right)}_{\frac{0}{0}} \stackrel{H}{=} \lim_{x \rightarrow 0} \left(\frac{3 \cdot \frac{1}{\cos(x)} \cdot (-\sin(x))}{2x}\right) \\ &= \lim_{x \rightarrow 0} \left(-\frac{\sin(x)}{x} \cdot \frac{3 \cos(x)}{2}\right) = -1 \cdot \frac{3 \cdot 1}{2} = -\frac{3}{2}\end{aligned}$$

Since $\ln(L) = -\frac{3}{2}$, it follows that $L = e^{-3/2}$.

(l) Factor out dominant terms. (LR is applicable, but you will get caught in an endless loop.)

$$\begin{aligned}\lim_{x \rightarrow \infty} \left(\frac{x}{\sqrt{3x^2 + 4}} \right) &= \lim_{x \rightarrow \infty} \left(\frac{x}{\sqrt{x^2 \left(3 + \frac{4}{x^2} \right)}} \right) = \lim_{x \rightarrow \infty} \left(\frac{x}{|x|} \cdot \frac{1}{\sqrt{3 + \frac{4}{x^2}}} \right) \\ &= \lim_{x \rightarrow \infty} \left(\frac{x}{x} \cdot \frac{1}{\sqrt{3 + \frac{4}{x^2}}} \right) = \lim_{x \rightarrow \infty} \left(1 \cdot \frac{1}{\sqrt{3 + \frac{4}{x^2}}} \right) \\ &= 1 \cdot \frac{1}{\sqrt{3 + 0}} = \frac{1}{\sqrt{3}}\end{aligned}$$

(m) Factor out dominant terms. (LR is applicable, but you will get caught in an endless loop.)

$$\lim_{x \rightarrow \infty} \left(\frac{e^x - e^{-x}}{e^x + e^{-x}} \right) = \lim_{x \rightarrow \infty} \left(\frac{e^x}{e^x} \cdot \frac{1 - e^{-2x}}{1 + e^{-2x}} \right) = \lim_{x \rightarrow \infty} \left(\frac{1 - e^{-2x}}{1 + e^{-2x}} \right) = 1 \cdot \frac{1 - 0}{1 + 0} = 1$$

(n) First determine the indeterminate exponent.

$$\lim_{x \rightarrow 0} \underbrace{(1 - \sin(2x))^{1/\tan(3x)}}_{1^{\pm\infty}} := L$$

Now consider $\ln(L)$.

$$\begin{aligned}\ln(L) &= \lim_{x \rightarrow 0} \underbrace{(\cot(3x) \cdot \ln(1 - \sin(2x)))}_{\pm\infty \cdot 0} = \lim_{x \rightarrow 0} \underbrace{\left(\frac{\ln(1 - \sin(2x))}{\tan(3x)} \right)}_{\frac{0}{0}} \\ &\stackrel{H}{=} \lim_{x \rightarrow 0} \left(\frac{\frac{1}{1 - \sin(2x)} \cdot (-2 \cos(2x))}{3 \sec(3x)^2} \right) = \frac{\frac{1}{1-0} \cdot (-2)}{3 \cdot 1} = -\frac{2}{3}\end{aligned}$$

Since $\ln(L) = -\frac{2}{3}$, it follows that $L = e^{-2/3}$.

(o) Standard application of LR.

$$\lim_{x \rightarrow 0} \underbrace{\left(\frac{x \sin(x)}{1 - \cos(x)} \right)}_{\frac{0}{0}} \stackrel{H}{=} \lim_{x \rightarrow 0} \underbrace{\left(\frac{x \cos(x) + \sin(x)}{\sin(x)} \right)}_{\frac{0}{0}} = \lim_{x \rightarrow 0} \left(\frac{x}{\sin(x)} \cdot \cos(x) + 1 \right) = 1 \cdot 1 + 1 = 2$$

(p) Write the product as a quotient, then use LR.

$$\begin{aligned}\lim_{x \rightarrow \pi/2} \underbrace{\left(\left(x - \frac{\pi}{2} \right) \tan(x) \right)}_{0 \cdot (\pm\infty)} &= \lim_{x \rightarrow \pi/2} \underbrace{\left(\frac{\left(x - \frac{\pi}{2} \right) \sin(x)}{\cos(x)} \right)}_{\frac{0}{0}} \\ &\stackrel{H}{=} \lim_{x \rightarrow \pi/2} \left(\frac{\left(x - \frac{\pi}{2} \right) \cos(x) + \sin(x)}{-\sin(x)} \right) = \frac{0 \cdot 0 + 1}{-1} = -1\end{aligned}$$

§4.9: Antiderivatives

Difficulty guide for this worksheet:*Core or Beyond Core:* 95, 96, 97*Advanced:* none*Removed from syllabus:* none**W95.** Find each of the following antiderivatives.

(a) $\int \frac{\cos(\theta)}{4} d\theta$

(e) $\int (86t^7 - \sqrt[3]{t}) dt$

(b) $\int (4 - 9x + x^2) dx$

(f) $\int \frac{3t^3 - 6\sqrt{t} - \frac{9}{t}}{t} dt$

(c) $\int (12e^x + \sin(x)) dx$

(d) $\int (6y - y^3)^2 dy$

(g) $\int \left(1 - \frac{1}{u}\right) \left(2 + \frac{3}{\sqrt{u}}\right) du$

Solution

(a) Use trigonometric derivative rules backwards.

$$\int \frac{\cos(\theta)}{4} d\theta = \frac{\sin(\theta)}{4} + C$$

(b) Use power rule backwards.

$$\int (4 - 9x + x^2) dx = 4x - \frac{9}{2}x^2 + \frac{1}{3}x^3 + C$$

(c) Use exponential and trigonometric derivative rules backwards.

$$\int (12e^x + \sin(x)) dx = 12e^x - \cos(x) + C$$

(d) Expand the integrand, then antidifferentiate.

$$\int (6y - y^3)^2 dy = \int (36y^2 - 12y^4 + y^6) dy = 12y^3 - \frac{12}{5}y^5 + \frac{1}{7}y^7 + C$$

(e) Use power rule backwards.

$$\int (86t^7 - \sqrt[3]{t}) dt = \frac{86}{8}t^8 - \frac{3}{4}t^{4/3} + C$$

(f) Write the integrand as a sum of power functions then antidifferentiate.

$$\int \frac{3t^3 - 6\sqrt{t} - \frac{9}{t}}{t} dt = \int \left(3t^2 - 6t^{-1/2} - 9t^{-2}\right) dt = t^3 - 12t^{1/2} + 9t^{-1} + C$$

(g) Expand the integrand, then antidifferentiate.

$$\begin{aligned} \int \left(1 - \frac{1}{u}\right) \left(2 + \frac{3}{\sqrt{u}}\right) du &= \int \left(2 + 3u^{-1/2} - 2u^{-1} - 3u^{-3/2}\right) du \\ &= 2u + 6u^{1/2} - 2\ln(|u|) + 6u^{-1/2} + C \end{aligned}$$

W96. The marginal revenue of a certain commodity is

$$MR(x) = -9x^2 + 24x + 48$$

Find the price that maximizes total revenue. (Assume that $R(0) = 0$.)

Solution

Revenue is maximized when $MR(x) = 0$ (since $MR(x) = R'(x)$).

$$0 = MR(x) = -9(3x + 4)(x - 4) \implies x = 4$$

So revenue is maximized when $x = 4$. To find the price, we first need to find the total revenue, which we obtain by antidifferentiation.

$$R(x) = \int MR(x) dx = \int (-9x^2 + 24x + 48) dx = -3x^3 + 12x^2 + 48x + C$$

Since $R(0) = 0$, we find that $C = 0$. So the total revenue is

$$R(x) = -3x^3 + 12x^2 + 48x$$

Since revenue is generally $R(x) = xp(x)$, it follows that the price is

$$p(x) = \frac{R(x)}{x} = -3x^2 + 12x + 48$$

Hence the price that maximizes the revenue is $p(4) = 48$.

W97. A particle moves along the x -axis in such a way that its acceleration at time $t > 0$ is

$$a(t) = 1 - \frac{1}{t^2}$$

The particle's velocity at time $t = 2$ is $v(2) = 5.5$. What is the net distance the particle travels between the times $t = 3$ and $t = 6$?

Solution

First we find the particle's velocity by anti-differentiating $a(t)$.

$$v(t) = \int a(t) dt = \int (1 - t^{-2}) dt = t + t^{-1} + C$$

Now we find the value of C by using the fact that $v(2) = 5.5$.

$$5.5 = 2 + \frac{1}{2} + C \implies C = 3$$

Hence the velocity of the particle is

$$v(t) = t + \frac{1}{t} + 3$$

Now we find the position of the particle by anti-differentiating $v(t)$.

$$x(t) = \int v(t) dt = \int \left(t + \frac{1}{t} + 3 \right) dt = \frac{1}{2}t^2 + \ln(|t|) + 3t + C$$

The value of C is not needed since we are only interested in a difference of position. The net distance traveled between $t = 3$ and $t = 6$ is

$$\begin{aligned} \Delta x &= x(6) - x(3) \\ &= \left(\frac{1}{2} \cdot 36 + \ln(6) + 18 + C \right) - \left(\frac{1}{2} \cdot 9 + \ln(3) + 9 + C \right) \\ &= 22.5 + \ln(2) \end{aligned}$$

2.5 Chapter 5: Integration

§5.1, 5.2: Introduction to the Integral

*Difficulty guide for this worksheet:**Core or Beyond Core:* 99, 100*Advanced:* none*Removed from syllabus:* 98

W98. For each part, first sketch the region under the graph of $y = f(x)$ on the given interval. Then approximate the area of each region by using a Riemann sum with right endpoints and the indicated number of rectangles.

(a) $f(x) = \frac{1}{x+4}$ on $[0, 2]$ for $n = 4$

(b) $f(x) = \sqrt{3+x^2}$ on $[1, 4]$ for $n = 6$

Solution

(a) The width of each rectangle is $\Delta x = \frac{2-0}{4} = 0.5$. The approximate area is calculated below.

Rectangle #	Width	Right endpoint (x -value)	Height (y -value)	Area
1	0.5	0.5	$1/4.5$	$1/9$
2	0.5	1	$1/5$	$1/10$
3	0.5	1.5	$1/5.5$	$1/11$
4	0.5	2	$1/6$	$1/12$

The total approximate area is

$$A = \frac{1}{9} + \frac{1}{10} + \frac{1}{11} + \frac{1}{12}$$

(b) The width of each rectangle is $\Delta x = \frac{4-1}{6} = 0.5$. The approximate area is calculated below.

Rectangle #	Width	Right endpoint (x -value)	Height (y -value)	Area
1	0.5	1.5	$\sqrt{5.25}$	$0.5\sqrt{5.25}$
2	0.5	2	$\sqrt{7}$	$0.5\sqrt{7}$
3	0.5	2.5	$\sqrt{9.25}$	$0.5\sqrt{9.25}$
4	0.5	3	$\sqrt{12}$	$0.5\sqrt{12}$
5	0.5	3.5	$\sqrt{15.25}$	$0.5\sqrt{15.25}$
6	0.5	4	$\sqrt{19}$	$0.5\sqrt{19}$

The total approximate area is

$$A = 0.5 \cdot \left(\sqrt{5.25} + \sqrt{7} + \sqrt{9.25} + \sqrt{12} + \sqrt{15.25} + \sqrt{19} \right)$$

W99. Use geometry to calculate each integral.

(a) $\int_{-1}^9 (27 - 3x) dx$

(d) $\int_{-3}^5 (|x| - 1) dx$

(b) $\int_{-2}^4 (3x + 15) dx$

(e) $\int_{-4}^0 \sqrt{16 - x^2} dx$

(c) $\int_0^{12} (2x - 10) dx$

(f) $\int_2^{10} \sqrt{64 - (x - 10)^2} dx$

W100. Use the graph below to calculate the following integrals. Write your answer in terms of a , b , and c , if necessary. If there is not information to calculate the integral, explain why.

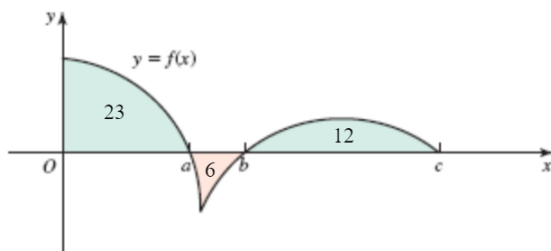

(a) $\int_0^a f(x) dx$

(d) $\int_0^c |f(x)| dx$

(g) $\int_c^a |f(x)| dx$

(b) $\int_0^b f(x) dx$

(e) $\int_0^c (2|f(x)| + 3f(x)) dx$

(h) $\int_0^c (2f(x) + 3) dx$

(c) $\int_a^c f(x) dx$

(f) $\int_a^0 f(x) dx$

(i) $\int_0^a f(x)^2 dx$

§5.3: Fundamental Theorem of Calculus

Difficulty guide for this worksheet:

Core or Beyond Core: 101 (all parts except j), 102 (all parts except b and c), 103, 104

Advanced: 101j

Removed from syllabus: 102b, 102c

W101. Evaluate each of the following integrals.

(a) $\int_{-3}^5 (-8) dx$

(d) $\int_0^9 \sqrt{x}(x^2 - x + 1) dx$

(h) $\int_{-\pi}^{\pi/2} \sin(x) dx$

(b) $\int_4^{36} \sqrt{2x} dx$

(e) $\int_9^{10} \frac{a}{x} dx$

(i) $\left| \int_{-\pi}^{\pi/2} \sin(x) dx \right|$

(c) $\int_{-\ln(3)}^{\ln(8)} 5e^x dx$

(f) $\int_{-4}^4 \sqrt{16 - x^2} dx$

(g) $\int_{-2}^5 (2x - |x|) dx$

(j) $\int_{-\pi}^{\pi/2} |\sin(x)| dx$

Solution

(a) Use FTC part 1.

$$\int_{-3}^5 (-8) dx = (-8x)|_{-3}^5 = (-40) - (24) = -64$$

(b) Use FTC part 1.

$$\begin{aligned} \int_4^{36} \sqrt{2x} dx &= \int_4^{36} \sqrt{2}x^{1/2} dx = \sqrt{2} \cdot \frac{2}{3}x^{3/2} \Big|_4^{36} \\ &= \left(\frac{2\sqrt{2}}{3} \cdot 216 \right) - \left(\frac{2\sqrt{2}}{3} \cdot 8 \right) = \frac{416\sqrt{2}}{3} \end{aligned}$$

(c) Use FTC part 1.

$$\int_{-\ln(3)}^{\ln(8)} 5e^x dx = 5e^x \Big|_{-\ln(3)}^{\ln(8)} = (5 \cdot 8) - \left(5 \cdot \frac{1}{3} \right) = \frac{115}{3}$$

(d) Use FTC part 1.

$$\begin{aligned} \int_0^9 \sqrt{x}(x^2 - x + 1) dx &= \int_0^9 \left(x^{5/2} - x^{3/2} + x^{1/2} \right) dx \\ &= \left(\frac{2}{7}x^{7/2} - \frac{2}{5}x^{5/2} + \frac{2}{3}x^{3/2} \right) \Big|_0^9 \\ &= \left(\frac{2}{7} \cdot 3^7 - \frac{2}{5} \cdot 3^5 + \frac{2}{3} \cdot 3^3 \right) - 0 = \frac{19,098}{35} \end{aligned}$$

(e) Use FTC part 1.

$$\int_9^{10} \frac{a}{x} dx = a \ln(|x|) \Big|_9^{10} = a \ln(10) - a \ln(9) = a \ln \left(\frac{10}{9} \right)$$

- (f) The integral represents the area under the curve $y = \sqrt{16 - x^2}$ and above the interval $[-4, 4]$ on the x -axis. This region is a half-disc centered at the origin with radius $r = 4$. Therefore the area (and the integral) is

$$\int_{-4}^4 \sqrt{16 - x^2} dx = \frac{1}{2} \pi \cdot 4^2 = 8\pi$$

- (g) First we write the integrand $y = 2x - |x|$ as a piecewise function.

$$2x - |x| = \begin{cases} 2x - (-x) & , \quad x < 0 \\ 2x - x & , \quad x \geq 0 \end{cases} = \begin{cases} 3x & , \quad x < 0 \\ x & , \quad x \geq 0 \end{cases}$$

Now we split the integral into two separate integrals.

$$\begin{aligned} \int_{-2}^5 (2x - |x|) dx &= \int_{-2}^0 (2x - |x|) dx + \int_0^5 (2x - |x|) dx = \int_{-2}^0 3x dx + \int_0^5 x dx \\ &= \left(\frac{3}{2} x^2 \Big|_{-2}^0 \right) + \left(\frac{1}{2} x^2 \Big|_0^5 \right) = (0 - \frac{3}{2}(-2)^2) + (\frac{1}{2} \cdot 5^2 - 0) = \frac{13}{2} \end{aligned}$$

- (h) Use FTC part 1.

$$\int_{-\pi}^{\pi/2} \sin(x) dx = -\cos(x) \Big|_{-\pi}^{\pi/2} = -\cos\left(\frac{\pi}{2}\right) - (-\cos(\pi)) = 0 - 1 = -1$$

- (i) Use the previous part.

$$\left| \int_{-\pi}^{\pi/2} \sin(x) dx \right| = |-1| = 1$$

- (j) Let $f(x) = \sin(x)$. Note that in the interval $[-\pi, \frac{\pi}{2}]$, we have that $f(x) = 0$ when $x = -\pi$ and $x = 0$. Sign analysis of f shows the following.

Interval	Test point	Sign of f
$(-\pi, 0)$	$\sin(-\frac{\pi}{2}) = -1$	\ominus
$(0, \frac{\pi}{2})$	$\sin(\frac{\pi}{4}) = \frac{1}{\sqrt{2}}$	\oplus

Hence we may write the integrand $y = |\sin(x)|$ as the following piecewise function.

$$|\sin(x)| = \begin{cases} -\sin(x) & , \quad -\pi \leq x \leq 0 \\ \sin(x) & , \quad 0 < x \leq \frac{\pi}{2} \end{cases}$$

Now we split the integral into two separate integrals.

$$\begin{aligned} \int_{-\pi}^{\pi/2} |\sin(x)| dx &= \int_{-\pi}^0 (-\sin(x)) dx + \int_0^{\pi/2} \sin(x) dx \\ &= \left(\cos(x) \Big|_{-\pi}^0 \right) + \left(-\cos(x) \Big|_0^{\pi/2} \right) \\ &= (\cos(0) - \cos(-\pi)) + (-\cos(\frac{\pi}{2}) - (-\cos(0))) \\ &= (1 - (-1)) + (0 - (-1)) = 3 \end{aligned}$$

W102. Find the derivative of each function.

$$(a) F(x) = \int_{-3}^x \frac{t^4 - t^2 + 1}{\sqrt{t^6 + 1}} dt$$

$$(c) F(t) = \int_1^{t^2} \frac{\sin(x)}{x} dx$$

$$(b) F(u) = \int_u^0 \frac{\ln(|y| + 4)}{e^y} dy$$

$$(d) F(x) = \int_{-\pi}^x \sqrt[3]{w}(w^2 - 2w + 5) dw$$

Solution

(a) Use FTC part 2.

$$F'(x) = \frac{x^4 - x^2 + 1}{\sqrt{x^6 + 1}}$$

(b) First switch the limits of integration and use integral identities.

$$F(u) = - \int_0^u \frac{\ln(|y| + 4)}{e^y} dy$$

Now use FTC part 2.

$$F'(u) = - \frac{\ln(|u| + 4)}{e^u}$$

(c) Use FTC part 2 and chain rule.

$$F'(t) = \frac{\sin(t^2)}{t^2} \cdot 2t$$

(d) Use FTC part 2.

$$F'(x) = \sqrt[3]{x}(x^2 - 2x + 5)$$

W103. Let $f(x)$ be the function below.

$$f(x) = \begin{cases} 4x - x^2 & , \quad x \leq 2 \\ \frac{8}{x} & , \quad x > 2 \end{cases}$$

(a) Show that f is continuous on the interval $[-1, 4]$.

(b) Draw a sketch of a region whose area is given by the integral $\int_{-1}^4 f(x) dx$.

(c) Evaluate the integral $\int_{-1}^4 f(x) dx$.

Solution

(a) Each “piece” of $f(x)$ is continuous on the respective domain. Hence the only point of possible discontinuity is $x = 2$. Now observe that

$$\lim_{x \rightarrow 2^-} f(x) = \lim_{x \rightarrow 2^-} (4x - x^2) = 8 - 4 = 4$$

$$\lim_{x \rightarrow 2^+} f(x) = \lim_{x \rightarrow 2^+} \left(\frac{8}{x} \right) = \frac{8}{2} = 4$$

$$f(2) = (4x - x^2)|_{x=2} = 4$$

Since these three numbers are all equal, $f(x)$ is continuous at $x = 2$.

(b) Graph each piece separately.

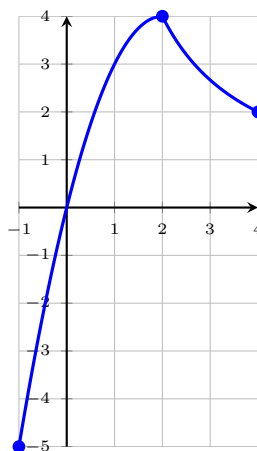

- (c) Since the definition of $f(x)$ changes at $x = 2$, we split the integral into two separate integrals.

$$\begin{aligned} \int_{-1}^4 f(x) dx &= \int_{-1}^2 f(x) dx + \int_2^4 f(x) dx = \int_{-1}^2 (4x - x^2) dx + \int_2^4 \frac{8}{x} dx \\ &= \left(2x^2 - \frac{1}{3}x^3\right)\Big|_{-1}^2 + 8\ln(|x|)\Big|_2^4 \\ &= \left(\left(8 - \frac{8}{3}\right) - \left(2 + \frac{1}{3}\right)\right) + (8\ln(4) - 8\ln(2)) = 3 + 8\ln(2) \end{aligned}$$

W104. The graph of the function f is given below. The graph consists of line segments and a semicircle.

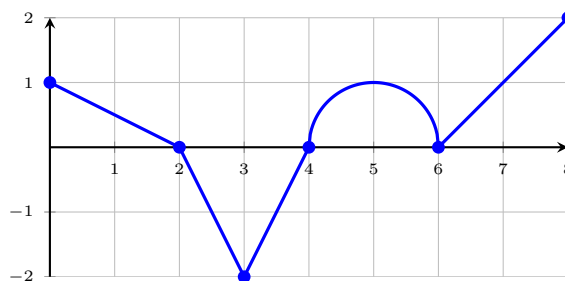

Define $g(x) = \int_0^x f(t) dt$.

- Where is g increasing?
- At what x -values does g have a local extremum in $(0, 8)$? Classify each as either a local maximum or a local minimum.
- Where is the graph of g concave down?
- At what x -values does g have an inflection point?
- Evaluate $g(8)$.
- Is the statement " $g(4) > g(2)$ " true or false? Explain your answer?

Solution

Note that the graph given is that of $y = f(x)$, *not* $y = g(x)$. When we analyze $g(x)$ we will need its derivatives. So observe that by the FTC part 2, we have

$$g'(x) = f(x) \quad , \quad g''(x) = f'(x)$$

So asking questions about $g'(x)$ is equivalent to asking the same questions of $f(x)$.

- (a) The first-order critical numbers are where $g'(x) = f(x)$ does not exist (nowhere) or $g'(x) = f(x) = 0$ ($x = 2, 4, 6$). Now we make a sign chart for $g' = f$.

interval	test point	sign	shape of g
$(0, 2)$	$g'(1) = f(1)$	\oplus	increasing
$(2, 4)$	$g'(3) = f(3)$	\ominus	decreasing
$(4, 6)$	$g'(5) = f(5)$	\oplus	increasing
$(6, 8)$	$g'(7) = f(7)$	\oplus	increasing

Hence g is increasing on $(0, 2)$ and $(4, 8)$.

- (b) The sign chart in part (a) shows that g has a local minimum at $x = 4$ and a local maximum at $x = 2$.
- (c) The second-order critical numbers are where $g''(x) = f'(x)$ does not exist ($x = 2, 3, 4, 6$) or $g''(x) = f'(x) = 0$ ($x = 5$). Now we make a sign chart for $g'' = f'$. (Recall that f' is the slope of the given graph.)

interval	test point	sign	shape of g
$(0, 2)$	$g''(1) = f'(1)$	\ominus	concave down
$(2, 3)$	$g''(2.5) = f'(2.5)$	\ominus	concave down
$(3, 4)$	$g''(3.5) = f'(3.5)$	\oplus	concave up
$(4, 5)$	$g''(4.5) = f'(4.5)$	\oplus	concave up
$(5, 6)$	$g''(5.5) = f'(5.5)$	\ominus	concave down
$(6, 8)$	$g''(7) = f'(7) = \oplus$	\oplus	concave up

Hence g is concave down on $(0, 3)$ and $(5, 6)$.

- (d) The sign chart in part (c) shows that g has inflection points at $x = 3$, $x = 5$, and $x = 6$.
- (e) The number $g(8)$ is the area “under” the graph of $y = f(x)$ and over the interval $[0, 8]$. This region consists of three triangles and a half-disc. Area above the x -axis is positive and area below the x -axis is negative.

$$g(8) = \frac{1}{2} \cdot 2 \cdot 1 - \frac{1}{2} \cdot 2 \cdot 2 + \frac{1}{2}\pi \cdot 1^2 + \frac{1}{2} \cdot 2 \cdot 2 = 1 + \frac{\pi}{2}$$

- (f) The statement is false. The sign chart in part (a) shows that g is decreasing on the interval $(2, 4)$. Hence $g(4) < g(2)$.

§5.5: Substitution Rule

Difficulty guide for this worksheet:

Core or Beyond Core: 105 (all parts except d), 106 (all parts except f), 107 (all parts except b)

Advanced: 105d, 106f, 107b

Removed from syllabus: none

W105. Find the following antiderivatives.

$$(a) \int (5x - 7)^{14} dx \qquad (c) \int \cos(4 - x) dx \qquad (e) \int \frac{1}{x \ln(x) \ln(\ln(x))} dx$$

$$(b) \int \frac{x^3}{\sqrt{9 - x^4}} dx \qquad (d) \int x\sqrt{2x + 1} dx \qquad (f) \int \frac{1}{\sqrt{w}(\sqrt{w} + 7)} dw$$

Solution

(a) Substitute $u = 5x - 7$.

$$\begin{aligned} u &= 5x - 7 \\ du &= 5 dx \\ dx &= \frac{du}{5} \end{aligned}$$

$$\int (5x - 7)^{14} dx = \int \frac{1}{5} u^{14} du = \frac{1}{75} u^{15} + C = \frac{1}{75} (5x - 7)^{15} + C$$

(b) Substitute $u = 9 - x^4$.

$$\begin{aligned} u &= 9 - x^4 \\ du &= -4x^3 dx \\ dx &= \frac{du}{-4x^3} \end{aligned}$$

$$\int \frac{x^3}{\sqrt{9 - x^4}} dx = \int \frac{x^3}{\sqrt{u}} \cdot \frac{du}{-4x^3} = \int \left(\frac{-1}{4} u^{-1/2} \right) du = \frac{-1}{2} u^{1/2} + C = -\frac{1}{2} \sqrt{9 - x^4} + C$$

(c) Substitute $u = 4 - x$.

$$\begin{aligned} u &= 4 - x \\ du &= -dx \\ dx &= -du \end{aligned}$$

$$\int \cos(4 - x) dx = \int (-\cos(u)) du = -\sin(u) + C = -\sin(4 - x) + C$$

(d) Substitute $u = 2x + 1$.

$$\begin{aligned} u &= 2x + 1 \\ x &= \frac{u - 1}{2} \\ du &= 2 dx \\ dx &= \frac{du}{2} \end{aligned}$$

$$\begin{aligned} \int x\sqrt{2x+1} dx &= \int \frac{u-1}{2} \cdot \sqrt{u} \cdot \frac{du}{2} = \int \frac{1}{4}(u^{3/2} - u^{1/2}) du \\ &= \frac{1}{4} \left(\frac{2}{5}u^{5/2} - \frac{2}{3}u^{3/2} \right) + C = \frac{1}{10}(2x+1)^{5/2} - \frac{1}{6}(2x+1)^{3/2} + C \end{aligned}$$

(e) Substitute $u = \ln(x)$.

$$\begin{aligned} u &= \ln(x) \\ du &= \frac{1}{x} dx \\ dx &= x du \end{aligned}$$

$$\int \frac{1}{x \ln(x) \ln(\ln(x))} dx = \int \frac{1}{xu \ln(u)} \cdot x du = \int \frac{1}{u \ln(u)} du$$

Now make a second substitution of $w = \ln(u)$.

$$\begin{aligned} w &= \ln(u) \\ dw &= \frac{1}{u} du \\ du &= u dw \end{aligned}$$

$$\int \frac{1}{u \ln(u)} du = \int \frac{1}{uw} \cdot u dw = \int \frac{1}{w} dw = \ln|w| + C = \ln|\ln(u)| + C = \ln|\ln(\ln(x))| + C$$

(f) Substitute $u = \sqrt{w} + 7$.

$$\begin{aligned} u &= \sqrt{w} + 7 \\ du &= \frac{1}{2\sqrt{w}} dw \\ dw &= 2\sqrt{w} du \end{aligned}$$

$$\int \frac{1}{\sqrt{w}(\sqrt{w} + 7)} dw = \int \frac{1}{\sqrt{w}u} \cdot 2\sqrt{w} du = \int \frac{2}{u} du = 2 \ln|u| + C = 2 \ln|\sqrt{w} + 7| + C$$

W106. Calculate the following integrals.

(a) $\int_0^1 \frac{5x^2}{3x^3 + 2} dx$

(c) $\int_0^2 (e^{3x} - e^{-3x})^2 dx$

(e) $\int_1^{e^3} \frac{\ln(x)}{x} dx$

(b) $\int_{\pi/4}^{\pi/3} \tan(3\theta) d\theta$

(d) $\int_0^{\ln(2)} \frac{1}{1 + e^{-t}} dt$

(f) $\int_{-1}^1 \frac{2x}{2x - 9} dx$

Solution

(a) Substitute $u = 3x^3 + 2$

$u = 3x^3 + 2$	$x = 0 \implies u = 2$ $x = 1 \implies u = 5$
$du = 9x^2 dx$	
$dx = \frac{du}{9x^2}$	

$$\int_0^1 \frac{5x^2}{3x^3 + 2} dx = \int_2^5 \frac{5x^2}{u} \cdot \frac{du}{9x^2} = \int_2^5 \frac{5}{9} \frac{1}{u} du = \frac{5}{9} \ln(u) \Big|_2^5 = \frac{5}{9} (\ln(5) - \ln(2))$$

(b) Substitute $u = \cos(3\theta)$ and write $\tan(3\theta) = \frac{\sin(3\theta)}{\cos(3\theta)}$.

$u = \cos(3\theta)$	$\theta = \frac{\pi}{4} \implies u = -\frac{1}{\sqrt{2}}$ $\theta = \frac{\pi}{3} \implies u = -1$
$du = -3 \sin(3\theta) d\theta$	
$d\theta = \frac{du}{-3 \sin(3\theta)}$	

$$\begin{aligned} \int_{-\pi/4}^{\pi/3} \tan(3\theta) d\theta &= \int_{-1/\sqrt{2}}^{-1} \frac{\sin(3\theta)}{u} \cdot \frac{du}{-3 \sin(3\theta)} = \int_{-1/\sqrt{2}}^{-1} \left(-\frac{1}{3} \cdot \frac{1}{u} \right) du \\ &= -\frac{1}{3} \ln|u| \Big|_{-1/\sqrt{2}}^{-1} = -\frac{1}{3} (\ln(1) - \ln(1/\sqrt{2})) = -\frac{\ln(2)}{6} \end{aligned}$$

(c) First expand the integrand.

$$\int_0^2 (e^{3x} - e^{-3x})^2 dx = \int_0^2 (e^{6x} - 2 + e^{-6x}) dx$$

Observe the following simple antiderivatives.

$$\int e^{6x} dx = \frac{e^{6x}}{6} + C \quad , \quad \int e^{-6x} dx = -\frac{e^{-6x}}{6} + C$$

(These antiderivatives can be determined by inspection or by substitution of $u = 6x$ or $u = -6x$.) So now we have the following.

$$\int_0^2 (e^{6x} - 2 + e^{-6x}) dx = \left(\frac{e^{6x}}{6} - 2x - \frac{e^{-6x}}{6} \right) \Big|_0^2 = \frac{e^{12}}{6} - 4 - \frac{e^{-12}}{6}$$

(d) First rewrite the integrand using algebra.

$$\frac{1}{1 + e^{-t}} = \frac{e^t}{e^t + 1}$$

Now substitute $u = e^t + 1$.

$$\begin{array}{l} u = e^t + 1 \\ du = e^t dt \\ dt = \frac{du}{e^t} \end{array} \quad \begin{array}{l} t = 0 \implies u = 2 \\ t = \ln(2) \implies u = 3 \end{array}$$

$$\int_0^{\ln(2)} \frac{e^t}{e^t + 1} dt = \int_2^3 \frac{e^t}{u} \cdot \frac{du}{e^t} = \int_2^3 \frac{1}{u} du = \ln(u) \Big|_2^3 = \ln(3) - \ln(2)$$

(e) Substitute $u = \ln(x)$.

$$\begin{array}{l} u = \ln(x) \\ du = \frac{1}{x} dx \\ dx = x du \end{array} \quad \begin{array}{l} x = 1 \implies u = 0 \\ x = e^3 \implies u = 3 \end{array}$$

$$\int_1^{e^3} \frac{\ln(x)}{x} dx = \int_0^3 \frac{u}{x} \cdot x du = \int_0^3 u du = \frac{1}{2} u^2 \Big|_0^3 = \frac{9}{2}$$

(f) Substitute $u = 2x - 9$.

$$\begin{array}{l} u = 2x - 9 \\ u + 9 = 2x \\ du = 2 dx \\ dx = \frac{du}{2} \end{array} \quad \begin{array}{l} x = -1 \implies u = -11 \\ x = 1 \implies u = -7 \end{array}$$

$$\begin{aligned} \int_{-1}^1 \frac{2x}{2x-9} dx &= \int_{-11}^{-7} \frac{u+9}{u} \cdot \frac{du}{2} = \int_{-11}^{-7} \frac{1}{2} \left(1 + \frac{9}{u} \right) du = \frac{1}{2} (u + 9 \ln|u|) \Big|_{-11}^{-7} \\ &= \frac{1}{2} (-7 + 9 \ln(7)) - \frac{1}{2} (-11 + 9 \ln(11)) = 2 + \frac{9}{2} \ln \left(\frac{7}{11} \right) \end{aligned}$$

W107. Find the area of the region under the given curve.

(a) $y = t\sqrt{t^2 + 9}$ on $[0, 4]$

(c) $y = \sin(2x)^2 \cos(2x)$ on $[0, \frac{\pi}{4}]$

(b) $y = x(x-3)^{1/3}$ on $[3, 11]$

(d) $y = \frac{e^{\sqrt{x}}}{\sqrt{x}}$ on $[1, 9]$

Solution

(a) Substitute $u = t^2 + 9$.

$$\begin{array}{l} u = t^2 + 9 \\ du = 2t dt \\ dt = \frac{du}{2t} \end{array} \quad \begin{array}{l} t = 0 \implies u = 9 \\ t = 4 \implies u = 25 \end{array}$$

$$A = \int_0^4 t\sqrt{t^2+9} dt = \int_9^{25} t\sqrt{u} \frac{du}{2t} = \int_9^{25} \frac{1}{2}u^{1/2} du = \frac{1}{3}u^{3/2} \Big|_9^{25} = \frac{1}{3}(125 - 27) = \frac{98}{3}$$

(b) Substitute $u = x - 3$.

$\begin{aligned} u &= x - 3 \\ xu + 3 & \\ du &= dx \end{aligned}$	$\begin{aligned} x = 3 &\implies u = 0 \\ x = 11 &\implies u = 8 \end{aligned}$
--	---

$$\begin{aligned} A &= \int_3^{11} x(x-3)^{1/3} dx = \int_0^8 (u+3)u^{1/3} du = \int_0^8 (u^{4/3} + 3u^{1/3}) du \\ &= \left(\frac{3}{7}u^{7/3} + \frac{9}{4}u^{4/3} \right) \Big|_0^8 = \frac{3}{7} \cdot 128 + \frac{9}{4} \cdot 16 - 0 = \frac{636}{7} \end{aligned}$$

(c) Substitute $u = \sin(2x)$.

$\begin{aligned} u &= \sin(2x) \\ du &= 2 \cos(2x) dx \\ dx &= \frac{du}{2 \cos(2x)} \end{aligned}$	$\begin{aligned} x = 0 &\implies u = 0 \\ x = \frac{\pi}{4} &\implies u = 1 \end{aligned}$
---	--

$$A = \int_0^{\pi/4} \sin(2x)^2 \cos(2x) dx = \int_0^1 u^2 \cos(2x) \cdot \frac{du}{2 \cos(2x)} = \int_0^1 \frac{1}{2}u^2 du = \frac{1}{6}u^3 \Big|_0^1 = \frac{1}{6}$$

(d) Substitute $u = \sqrt{x}$.

$\begin{aligned} u &= \sqrt{x} \\ du &= \frac{1}{2\sqrt{x}} dx \\ dx &= 2\sqrt{x} du \end{aligned}$	$\begin{aligned} x = 1 &\implies u = 1 \\ x = 9 &\implies u = 3 \end{aligned}$
---	--

$$A = \int_1^9 \frac{e^{\sqrt{x}}}{\sqrt{x}} dx = \int_1^3 \frac{e^u}{\sqrt{x}} \cdot 2\sqrt{x} du = \int_1^3 2e^u du = 2e^u \Big|_1^3 = 2e^3 - 2e$$

2.6 Unit Review

Unit #2 Review: Limits and Continuity (2.1 – 2.6, 3.5)

Difficulty guide for this worksheet:

Core or Beyond Core: 108, 109, 110, 111, 112, 113, 114

Advanced: none

Removed from syllabus: none

W108. For each part, calculate the limit or show that it does not exist.

(a) $\lim_{x \rightarrow 0} \left(\frac{\sin(5x)}{3x} \cos(4x) \right)$ (b) $\lim_{x \rightarrow -2} \left(\frac{x^2 + 3x + 2}{x^2 + x - 2} \right)$ (c) $\lim_{x \rightarrow 0} \left(\frac{1}{x} - \frac{1}{x^2 + x} \right)$

Solution

(a) Recall that $\lim_{x \rightarrow 0} \frac{\sin(ax)}{ax} = 1$ for any $a \neq 0$. Hence we have

$$\lim_{x \rightarrow 0} \left(\frac{\sin(5x)}{3x} \cos(4x) \right) = \lim_{x \rightarrow 0} \left(\frac{5}{3} \cdot \frac{\sin(5x)}{5x} \cdot \cos(4x) \right) = \frac{5}{3} \cdot 1 \cdot 1 = \frac{5}{3}$$

(b) Cancel common factors, and then use direct substitution.

$$\lim_{x \rightarrow -2} \left(\frac{x^2 + 3x + 2}{x^2 + x - 2} \right) = \lim_{x \rightarrow -2} \left(\frac{(x+2)(x+1)}{(x+2)(x-1)} \right) = \lim_{x \rightarrow -2} \left(\frac{x+1}{x-1} \right) = \frac{-2+1}{-2-1} = \frac{1}{3}$$

(c) Find a common denominator, cancel common factors, and then use direct substitution.

$$\lim_{x \rightarrow 0} \left(\frac{1}{x} - \frac{1}{x^2 + x} \right) = \lim_{x \rightarrow 0} \left(\frac{x+1-1}{x^2 + x} \right) = \lim_{x \rightarrow 0} \left(\frac{1}{x+1} \right) = \frac{1}{0+1} = 1$$

W109. The graph of $f(x)$ is given below. Find all values of x in the interval $(-4, 4)$ for which f is not continuous.

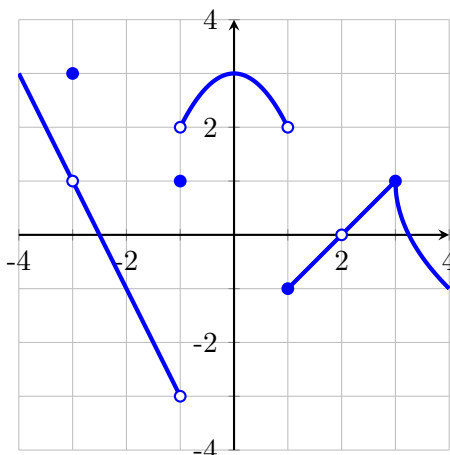

Solution

The function $f(x)$ is discontinuous at $x = -3$, $x = -1$, $x = 1$, and $x = 2$.

W110. Find the values of the constants a and b that make f continuous at $x = 9$.

$$f(x) = \begin{cases} \sin(2\pi x) - 2ax & , x < 9 \\ b & , x = 9 \\ \frac{x-9}{\sqrt{x}-3} & , x > 9 \end{cases}$$

You must use proper calculus and notation to give a complete and clear justification for your answer.

Solution

If f is to be continuous at $x = 9$, then the left-limit, right-limit, and function value must all be equal at $x = 9$. So we first calculate each of these values.

$$\lim_{x \rightarrow 9^-} f(x) = \lim_{x \rightarrow 9^-} (\sin(2\pi x) - 2ax) = \sin(18\pi) - 18a = -18a$$

$$\lim_{x \rightarrow 9^+} f(x) = \lim_{x \rightarrow 9^+} \left(\frac{x-9}{\sqrt{x}-3} \right) = \lim_{x \rightarrow 9^+} (\sqrt{x} + 3) = 6$$

$$f(9) = b$$

These three values must be equal, so that $-18a = 6 = b$, whence $a = -1/3$ and $b = 6$.

W111. Find the equation of each horizontal asymptote of $f(x) = \frac{2e^x - 5}{3e^x + 2}$. Write "NONE" as your answer if appropriate.

Solution

We calculate the limits of f at infinity. For the limit $x \rightarrow \infty$, we have the indeterminate form $\frac{\infty}{\infty}$, so we use L'Hôpital's Rule.

$$\lim_{x \rightarrow \infty} \left(\frac{2e^x - 5}{3e^x + 2} \right) \stackrel{H}{=} \lim_{x \rightarrow \infty} \left(\frac{2e^x}{3e^x} \right) = \frac{2}{3}$$

For the limit $x \rightarrow -\infty$ recall that $e^x \rightarrow 0$, and so

$$\lim_{x \rightarrow -\infty} \left(\frac{2e^x - 5}{3e^x + 2} \right) = \frac{0 - 5}{0 + 2} = -\frac{5}{2}$$

So the two horizontal asymptotes of $f(x)$ are $y = 2/3$ and $y = -5/2$.

W112. Find all vertical asymptotes of $f(x) = \frac{x^2 + x - 2}{x^2 - 4x + 3}$. Justify your answer. At each vertical asymptote, also calculate the corresponding one-sided limits.

Solution

Since $f(x)$ is a rational function, it is continuous on its domain, and so a vertical asymptote can occur only where the denominator vanishes. Solving $x^2 - 4x + 3 = (x-1)(x-3) = 0$, we find that a vertical asymptote can occur only at $x = 1$ or $x = 3$. Now we check each of these x -values individually.

For $x = 1$, we observe the following:

$$\lim_{x \rightarrow 1} f(x) = \lim_{x \rightarrow 1} \left(\frac{(x-1)(x+2)}{(x-1)(x-3)} \right) = \lim_{x \rightarrow 1} \left(\frac{x+2}{x-3} \right) = -\frac{3}{2}$$

Since this limit is not infinite, there is no vertical asymptote at $x = 1$.

For $x \neq 1$, we have already observed that we may write

$$f(x) = \frac{x+2}{x-3}$$

For $x = 3$ in particular, we see that direct substitution gives the (undefined) expression " $\frac{5}{0}$ ", a nonzero number divided by zero. Hence both the left- and right-limit at $x = 3$ are infinite, and so $x = 3$ is a true vertical asymptote. As for those one-sided limits, we observe that if $x \rightarrow 3$, then $(x+2) \rightarrow 5$, and so the numerator of $f(x)$ remains positive. However, the denominator $(x-3)$ remains negative if $x \rightarrow 3^-$ and remains positive if $x \rightarrow 3^+$. In summary,

$$\begin{aligned} \lim_{x \rightarrow 3^-} f(x) &= \lim_{x \rightarrow 3^-} \left(\frac{x+2}{x-3} \right) = \frac{\oplus}{\ominus} \infty = -\infty \\ \lim_{x \rightarrow 3^+} f(x) &= \lim_{x \rightarrow 3^+} \left(\frac{x+2}{x-3} \right) = \frac{\oplus}{\oplus} \infty = +\infty \end{aligned}$$

W113. For what values of a and b is the following function continuous for all x ?

$$g(x) = \begin{cases} ax + 2b & , \quad x \leq 0 \\ x^2 + 3a - b & , \quad 0 < x \leq 2 \\ 3x - 5 & , \quad x > 2 \end{cases}$$

Solution

Any values of a and b make each individual piece continuous for all real numbers. Hence we need only force continuity at $x = 0$ and $x = 2$. For $x = 0$, we have:

$$\begin{aligned} \lim_{x \rightarrow 0^-} f(x) &= \lim_{x \rightarrow 0^-} (ax + 2b) = 2b \\ \lim_{x \rightarrow 0^+} f(x) &= \lim_{x \rightarrow 0^+} (x^2 + 3a - b) = 3a - b \\ f(0) &= 2b \end{aligned}$$

Hence we must have $2b = 3a - b$ (equivalently, $a = b$) to have continuity at $x = 0$. For $x = 2$, we have:

$$\begin{aligned} \lim_{x \rightarrow 2^-} f(x) &= \lim_{x \rightarrow 2^-} (x^2 + 3a - b) = 4 + 3a - b \\ \lim_{x \rightarrow 2^+} f(x) &= \lim_{x \rightarrow 2^+} (3x - 5) = 1 \\ f(2) &= 4 + 3a - b \end{aligned}$$

Hence we must have $4 + 3a - b = 1$ to have continuity at $x = 2$. We already have that $a = b$, and so our condition for continuity at $x = 2$ becomes $4 + 2a = 1$, or $a = -3/2$. Hence for g to be continuous for all x , we must have $a = b = -3/2$.

W114. Let $f(x) = \frac{2e^x + 3}{1 - e^x}$.

- (a) Find all horizontal asymptotes of f , if any.
 (b) Find all vertical asymptotes of f . Then at each vertical asymptote, find both corresponding one-sided limits.

Solution

- (a) Recall that $e^x \rightarrow 0$ as $x \rightarrow -\infty$. So we have the following.

$$\lim_{x \rightarrow -\infty} \left(\frac{2e^x + 3}{1 - e^x} \right) = \frac{0 + 3}{1 - 0} = 3$$

Recall that $e^x \rightarrow \infty$ as $x \rightarrow \infty$. So we have the following.

$$\lim_{x \rightarrow \infty} f(x) = \lim_{x \rightarrow \infty} \left(\frac{e^x}{e^x} \cdot \frac{2 + 3e^{-x}}{e^{-x} - 1} \right) = \lim_{x \rightarrow \infty} \left(\frac{2 + 3e^{-x}}{e^{-x} - 1} \right) = \frac{2 + 0}{0 - 1} = -2$$

Hence the horizontal asymptotes are the lines $y = -2$ and $y = 3$.

- (b) Candidate vertical asymptotes occur at x -values where $1 - e^x = 0$. Hence the only candidate vertical asymptote is the line $x = 0$. (In the following work, we verify that $x = 0$ really is a vertical asymptote.)

Note that if x is a small negative number (i.e., $x \rightarrow 0^-$), then e^x is slightly less than 1, and so $1 - e^x$ is slightly positive. Hence we have

$$\lim_{x \rightarrow 0^-} \left(\frac{2e^x + 3}{1 - e^x} \right) = \frac{5}{0^+} = +\infty$$

Similarly, if x is a small positive number (i.e., $x \rightarrow 0^+$), then e^x is slightly greater than 1, and so $1 - e^x$ is slightly negative. Hence we have

$$\lim_{x \rightarrow 0^+} \left(\frac{2e^x + 3}{1 - e^x} \right) = \frac{5}{0^-} = -\infty$$

Unit #3 Review: Derivatives and Tangent Lines (3.1 – 3.9)

Difficulty guide for this worksheet:

Core or Beyond Core: 115, 116, 117, 118, 119, 120, 121, 123a, 124, 125, 126, 127

Advanced: 122, 123b

Removed from syllabus: none

W115. For each part, calculate $f'(x)$. Do not simplify your answer after computing the derivative.

(a) $f(x) = \frac{\tan(x)}{\pi - \sec(x)}$

(c) $f(x) = \sqrt{\ln(x^2 + 4) + x \sin(2x)}$

(b) $f(x) = \cos(e^{-3x})$

(d) $f(x) = \frac{e^{1/x}}{x^{2/3} + x^{1/3}}$

Solution

(a) Use quotient rule.

$$f'(x) = \frac{(\pi - \sec x)(\sec^2 x) - (\tan x)(-\sec x \tan x)}{(\pi - \sec x)^2}$$

(b) Use the chain rule twice.

$$f'(x) = -\sin(e^{-3x}) \cdot e^{-3x} \cdot (-3)$$

(c) Use chain rule first on the outermost square root function. Then use chain rule and product rule to compute the derivative of the inner function.

$$f'(x) = \frac{1}{2} (\ln(x^2 + 4) + x \sin(2x))^{-1/2} \cdot \left(\frac{2x}{x^2 + 4} + \sin(2x) + 2x \cos(2x) \right)$$

(d) Start with quotient rule. When differentiating the numerator, use chain rule.

$$f'(x) = \frac{e^{1/x} \cdot \left(\frac{-1}{x^2}\right) \cdot (x^{2/3} + x^{1/3}) - e^{1/x} \cdot \left(\frac{2}{3}x^{-1/3} + \frac{1}{3}x^{-2/3}\right)}{(x^{2/3} + x^{1/3})^2}$$

W116. Some values of g , h , g' , and h' are given below. Use this table to answer parts (a) and (b).

x	$g(x)$	$g'(x)$	$h(x)$	$h'(x)$
0	1	7	2	3
2	-3	-9	1	5
4	5	-1	1	-6

(a) Let $f(x) = 3g(x)h(x)$. Calculate $f'(2)$.

(b) Let $F(x) = g(\sqrt{x})$. Calculate $F'(4)$.

Solution

(a) Use product rule.

$$f'(x) = 3g'(x)h(x) + 3g(x)h'(x)$$

Then substitute $x = 2$ and use the table of values.

$$f'(2) = 3(-9)(1) + 3(-3)(5) = -72$$

(b) Use chain rule.

$$F'(x) = g'(\sqrt{x}) \cdot \frac{1}{2\sqrt{x}}$$

Then substitute $x = 4$ and use the table of values.

$$F'(4) = g'(2) \cdot \frac{1}{2 \cdot 2} = -\frac{9}{4}$$

W117. Find an equation of the line normal to the graph of $f(x) = 2x^2 - \ln(x) + 3$ at $x = 1$. (Recall that the normal line is perpendicular to the tangent line.)

Solution

The derivative at a general point is

$$f'(x) = 4x - \frac{1}{x}$$

Hence $f'(1) = 3$, and so the slope of the normal line is $-1/3$. The normal line must pass through $(1, f(1)) = (1, 5)$. Hence the equation of the normal line is

$$y - 5 = -\frac{1}{3}(x - 1)$$

W118. Let $f(x) = 3\sqrt{x}$. Use the limit definition of the derivative to find $f'(x)$. Show all work.

Solution

We have the following work.

$$\begin{aligned} f'(x) &= \lim_{h \rightarrow 0} \frac{f(x+h) - f(x)}{h} = \lim_{h \rightarrow 0} \frac{3\sqrt{x+h} - 3\sqrt{x}}{h} \\ &= \lim_{h \rightarrow 0} \frac{9(x+h) - 9x}{h(3\sqrt{x+h} + 3\sqrt{x})} = \lim_{h \rightarrow 0} \frac{9h}{h(3\sqrt{x+h} + 3\sqrt{x})} \\ &= \lim_{h \rightarrow 0} \frac{9}{3\sqrt{x+h} + 3\sqrt{x}} = \frac{9}{3\sqrt{x+0} + 3\sqrt{x}} = \frac{3}{2\sqrt{x}} \end{aligned}$$

W119. Find the x -coordinate of each point on the graph of $y = \frac{1}{\sqrt{x}}(x^3 + 15)$ where the tangent line is perpendicular to the line $x + 5y = 1$.

Solution

The slope of the given line $x + 5y = 1$ is $-\frac{1}{5}$, whence we want to find all tangent lines with slope 5. Let $f(x) = \frac{1}{\sqrt{x}}(x^3 + 15)$. So we must solve the equation $f'(x) = 5$. First we calculate $f'(x)$ by rewriting $f(x)$ in terms of power functions and using power rule.

$$f(x) = x^{5/2} + 15x^{-1/2} \implies f'(x) = \frac{5}{2}x^{3/2} - \frac{15}{2}x^{-3/2}$$

Now we set up and solve the equation $f'(x) = 5$.

$$\begin{aligned}\frac{5}{2}x^{3/2} - \frac{15}{2}x^{-3/2} &= 5 \\ 5x^{3/2} - 15x^{-3/2} &= 10 \\ x^{3/2} - 3x^{-3/2} &= 2 \\ x^3 - 3 &= 2x^{3/2} \\ x^3 - 2x^{3/2} - 3 &= 0 \\ (x^{3/2} + 1)(x^{3/2} - 3) &= 0\end{aligned}$$

The equation $x^{3/2} + 1 = 0$ has no solution since $x^{3/2} \geq 0$ for all x . The equation $x^{3/2} - 3 = 0$ has the unique solution $x = 3^{2/3}$ (which can also be written as $x = 9^{1/3}$). Hence the only solution to $f'(x) = 5$, and thus the only x -coordinate at which the tangent line is perpendicular to $x + 5y = 1$, is $x = 9^{1/3}$.

W120. Find the slope of the tangent line to the curve $x^3 - y^3 = y - 1$ at the point $(1, 1)$.

Solution

Implicitly differentiate the equation with respect to x to obtain

$$3x^2 - 3y^2 \cdot \frac{dy}{dx} = \frac{dy}{dx}$$

Substituting the point $(x, y) = (1, 1)$ gives

$$3 - 3\frac{dy}{dx} = \frac{dy}{dx}$$

Finally solving for $\frac{dy}{dx}$ gives the slope of the desired tangent line: $\frac{dy}{dx} = \frac{3}{4}$.

W121. Calculate the derivative of $f(x) = x^x$. Your final answer must contain only x .

Solution

Let $y = x^x$, so that $\ln(y) = x \ln(x)$. Implicitly differentiating this last equation gives

$$\frac{1}{y} \frac{dy}{dx} = 1 + \ln(x)$$

Solving for $\frac{dy}{dx}$ and substituting $y = x^x$ gives

$$f'(x) = \frac{dy}{dx} = x^x (1 + \ln(x))$$

W122. Suppose x and y satisfy the following equation.

$$x^2 + xy + 3y^2 = 99$$

- Find all points on the graph where the tangent line is horizontal.
- Find all points on the graph where the tangent line is vertical.

Solution

For both parts of the question, we need y' . So first differentiate both sides with respect to x .

$$2x + xy' + y + 6yy' = 0$$

Solving for y' gives

$$y' = -\frac{2x + y}{x + 6y}$$

- (a) The tangent line is horizontal where $y' = 0$. This means the numerator of y' must be equal to 0 and the denominator must be not equal to 0. Setting the numerator of y' equal to 0 gives the equation $2x + y = 0$, or $y = -2x$. Hence any point on the graph where the tangent line is horizontal must satisfy both the equation $x^2 + xy + 3y^2 = 99$ and $y = -2x$. Substitution of the latter into the former gives

$$99 = x^2 + x(-2x) + 3(-2x)^2 = 11x^2$$

Solving for x gives $x = \pm 3$. Hence there are two points on the graph where the tangent line is horizontal.

$$P_1 = (-3, 6)$$

$$P_2 = (3, -6)$$

We may then verify that neither of these points causes the denominator of y' to be equal to 0.

- (b) The tangent line is vertical where y' is infinite. This means the denominator of y' must be equal to 0 and the numerator must be not equal to 0. Setting the denominator of y' equal to 0 gives the equation $x + 6y = 0$, or $x = -6y$. Hence any point on the graph where the tangent line is vertical must satisfy both the equation $x^2 + xy + 3y^2 = 99$ and $x = -6y$. Substitution of the latter into the former gives

$$99 = (-6y)^2 + (-6y)y + 3y^2 = 33y^2$$

Solving for y gives $y = \pm\sqrt{3}$. Hence there are two points on the graph where the tangent line is horizontal.

$$P_1 = (6\sqrt{3}, -\sqrt{3})$$

$$P_2 = (-6\sqrt{3}, \sqrt{3})$$

We may then verify that neither of these points causes the numerator of y' to be equal to 0.

W123. For each part, find $f'(x)$ as a function of x only. Do not simplify your answer.

(a) $f(x) = (x^3 + x)^{10}$

(b) $f(x) = x^{\sin(2x)}$

Solution

(a) $f'(x) = 10(x^3 + x)^9(3x^2 + 1)$

(b) Let $y = x^{\sin(2x)}$, so that $\ln(y) = \sin(2x) \ln(x)$. Now implicitly differentiate.

$$\frac{1}{y} \cdot y' = \sin(2x) \cdot \frac{1}{x} + 2 \cos(2x) \ln(x)$$

Solving for y' and substituting $y = x^{\sin(2x)}$ gives

$$f'(x) = x^{\sin(2x)} \cdot \left(\frac{\sin(2x)}{x} + 2 \cos(2x) \ln(x) \right)$$

W124. If $x^3 + xy + y^2 = 7$, find $\frac{dy}{dx}$ at $(1, 2)$.

Solution

Implicitly differentiating with respect to x gives

$$3x^2 + xy' + y + 2yy' = 0$$

Substituting $(x, y) = (1, 2)$ gives $5 + 5y' = 0$, whence $y' = -1$.

W125. Let $f(x) = \frac{x+2}{x-3}$. Use the limit definition of derivative to find $f'(2)$.

Solution

Start with the definition of the derivative and then use algebra to eliminate the indeterminate form.

$$\begin{aligned} f'(2) &= \lim_{h \rightarrow 0} \left(\frac{f(2+h) - f(2)}{h} \right) = \lim_{h \rightarrow 0} \left(\frac{\frac{h+4}{h-1} - (-4)}{h} \right) = \lim_{h \rightarrow 0} \left(\frac{h+4+4(h-1)}{h(h-1)} \right) \\ &= \lim_{h \rightarrow 0} \left(\frac{h+4+4h-4}{h(h-1)} \right) = \lim_{h \rightarrow 0} \left(\frac{5h}{h(h-1)} \right) = \lim_{h \rightarrow 0} \left(\frac{5}{h-1} \right) = \frac{5}{0-1} = -5 \end{aligned}$$

W126. Find the derivative of each function.

(a) $f(x) = \tan(3x^2 + e)$

(b) $f(x) = e^{x/(x+1)}$

Solution

(a) $f'(x) = \sec(3x^2 + e)^2 \cdot 6x$

(b) $f'(x) = e^{x/(x+1)} \cdot \left(\frac{(x+1) \cdot 1 - x \cdot 1}{(x+1)^2} \right) = e^{x/(x+1)} \cdot \frac{1}{(x+1)^2}$

W127. Find the equation of the line normal to the curve $5x^2y + 2y^3 = 22$ at the point $(2, 1)$.

Solution

Implicitly differentiating with respect to x gives us

$$5x^2y' + 10xy + 6y^2y' = 0$$

Substituting $(x, y) = (2, 1)$ gives $26y' + 20 = 0$, whence $y' = -\frac{10}{13}$. Hence the normal line has a slope of $m = \frac{13}{10}$ and passes through the point $(2, 1)$. An equation for the normal line is thus

$$y = 1 + \frac{13}{10}(x - 2)$$

Unit #4 Review: Applications of the Derivative (3.11, 4.1, 4.3 – 4.7, 4.9)

Difficulty guide for this worksheet:

Core or Beyond Core: all except 131b, 141, and 150

Advanced: 131b, 141, 150

Removed from syllabus: none

- W128.** The total revenue from selling x units of a certain product is $R(x) = 40 - \frac{200}{x+5}$. Using marginal analysis, estimate the revenue from selling the 6th unit.

Solution

The revenue from the 6th item is $MR(5)$, which may be approximated by $R'(5)$.

$$R'(x) = \frac{200}{(x+5)^2} \implies MR(5) \approx R'(5) = \frac{200}{(5+5)^2} = 2$$

- W129.** Use a linear approximation to estimate the value of $(16.32)^{1/4}$.

Solution

We put $f(x) = x^{1/4}$ and find the linearization (tangent line) of $f(x)$ at $x = 16$. Observe that $f(16) = 2$ and $f'(16) = \frac{1}{4} \cdot 16^{-3/4} = \frac{1}{32}$. So the desired linearization is

$$x^{1/4} \approx 2 + \frac{1}{32}(x - 16)$$

which is a valid approximation if x is close to 16. Hence

$$(16.32)^{1/4} \approx 2 + \frac{1}{32}(16.32 - 16) = 2.01$$

- W130.** The surface area of a sphere is changing at a rate of 16π in²/s when its radius is 3 in. At what rate is the volume of the sphere changing at that time?

You must include correct units as part of your answer.

Hint: If a sphere has radius R , then its surface area A and volume V are given by

$$A = 4\pi R^2 \quad , \quad V = \frac{4\pi}{3} R^3$$

Solution

Implicitly differentiating each of the given formulas with respect to time t gives

$$\frac{dA}{dt} = 8\pi R \frac{dR}{dt} \quad , \quad \frac{dV}{dt} = 4\pi R^2 \frac{dR}{dt}$$

We are given that $\frac{dA}{dt} = 16\pi$ when $R = 3$, and substituting this information into this last pair of equations gives

$$16\pi = 24\pi \frac{dR}{dt} \quad , \quad \frac{dV}{dt} = 36\pi \frac{dR}{dt}$$

Solving for $\frac{dR}{dt}$ in the first of this last pair of equations gives $\frac{dR}{dt} = \frac{2}{3}$, and substituting this value into the second of this last pair of equations gives $\frac{dV}{dt} = 24\pi$. Hence the volume of the sphere is changing at a rate of $24\pi \text{ in}^3/\text{s}$.

W131. For each part, calculate the limit or show that it does not exist. If the limit is infinite, write “ ∞ ” or “ $-\infty$ ” as your answer, as appropriate.

(a) $\lim_{x \rightarrow 3^-} \left(\frac{x^2 + 6}{3 - x} \right)$ (b) $\lim_{x \rightarrow 0} (1 - \sin(3x))^{1/x}$ (c) $\lim_{x \rightarrow -3} \left((x + 3) \tan \left(\frac{\pi x}{2} \right) \right)$

Solution

- (a) Direct substitution of $x = 3$ gives the expression “ $\frac{15}{0}$ ”, which is not indeterminate, but instead indicates that the one-sided limit is infinite. Observe that the denominator $3 - x$ approaches 0 as $x \rightarrow 3^-$, but remains positive. (Recall that the notation $x \rightarrow 3^-$ implies $x < 3$.) Hence we have

$$\lim_{x \rightarrow 3^-} \left(\frac{x^2 + 6}{3 - x} \right) = \frac{\oplus}{\oplus} \infty = +\infty$$

- (b) Direct substitution of $x = 0$ gives the indeterminate exponent $1^{\pm\infty}$. So we will ultimately use L'Hôpital's Rule, but we must perform some algebra first to get the expression into the form of a quotient. Put

$$L = \lim_{x \rightarrow 0} (1 - \sin(3x))^{1/x}$$

and consider $\ln(L)$.

$$\ln(L) = \lim_{x \rightarrow 0} \ln \left[(1 - \sin(3x))^{1/x} \right] = \lim_{x \rightarrow 0} \left(\frac{\ln(1 - \sin(3x))}{x} \right)$$

Direct substitution of $x = 0$ now gives the indeterminate form $\frac{0}{0}$, and so we may use L'Hôpital's Rule.

$$\ln(L) = \lim_{x \rightarrow 0} \left(\frac{\frac{1}{1 - \sin(3x)} \cdot (-3 \cos(3x))}{1} \right) = \frac{1}{1 - 0} \cdot (-3 \cdot 1) = -3$$

(We have used direct substitution in the last step.) We have determined that $\ln(L) = -3$, whence we find that $L = e^{-3}$.

- (c) Direct substitution of $x = -3$ gives the indeterminate product $0 \cdot \infty$. So we will ultimately use L'Hôpital's Rule, but we must perform some algebra first to get the expression into the form of a quotient.

$$\lim_{x \rightarrow -3} \left((x + 3) \tan \left(\frac{\pi x}{2} \right) \right) = \lim_{x \rightarrow -3} \left(\frac{(x + 3) \sin(\pi x/2)}{\cos(\pi x/2)} \right)$$

Direct substitution of $x = -3$ now gives the indeterminate form $\frac{0}{0}$, and so we may use

L'Hôpital's Rule.

$$\begin{aligned}\lim_{x \rightarrow -3} \left(\frac{(x+3) \sin(\pi x/2)}{\cos(\pi x/2)} \right) &= \lim_{x \rightarrow -3} \left(\frac{(x+3) \cos(\pi x/2) \cdot (\pi/2) + \sin(\pi x/2)}{-\sin(\pi x/2) \cdot (\pi/2)} \right) \\ &= \frac{0 + (-1)}{-(-1) \cdot (\pi/2)} = -\frac{2}{\pi}\end{aligned}$$

(We have used direct substitution in the last step.)

- W132.** The position of a particle on the x -axis (measured in meters) at time t (measured in seconds) is modeled by the equation $f(t) = 100 + 8t^{3/4} - 5t$. Use a linear approximation to estimate the change in the particle's position between $t = 81$ and $t = 83$.

Solution

We want to estimate the difference $\Delta f = f(83) - f(81)$ using a tangent line approximation to $x(t)$, based at $t = 81$. Observe that $f'(t) = 6t^{-1/4} - 5$, whence $f'(81) = -3$, and so the tangent line to $f(t)$ at $t = 81$ is

$$y - f(81) = -3(t - 81)$$

This means that if t is close to 81, we may use the approximation

$$f(t) - f(81) \approx -3(t - 81)$$

Substituting $t = 83$ gives

$$\Delta f = f(83) - f(81) \approx -3(83 - 81) = -6$$

So the particle's position decreases by about 6 meters.

- W133.** A hot-air balloon flying at 10 ft/sec. and traveling in a straight line at a constant elevation of 400 ft passes directly over a spectator at an air show. How quickly is the angle of elevation (between the ground and the line from the spectator to balloon) changing 40 seconds later?

Solution

Let x be the horizontal distance on the ground from the spectator to the balloon and let θ be the angle of elevation. The height of the balloon is a constant 400 ft, and so, by elementary geometry, we have

$$x \tan(\theta) = 400$$

for all time t . Implicitly differentiating this equation with respect to time t gives

$$\frac{dx}{dt} \tan(\theta) + x \sec^2(\theta) \cdot \frac{d\theta}{dt} = 0$$

We are ultimately interested in the quantity $\frac{d\theta}{dt}$ at the moment 40 seconds after the balloon flies over the spectator. Since the balloon travels at a constant horizontal speed, at that time we have $x = (10 \text{ ft/sec}) \cdot (40 \text{ sec}) = 400 \text{ ft}$. Now we substitute $x = 400$ and $\frac{dx}{dt} = 10$ into our two

equations.

$$\begin{aligned}400 \tan(\theta) &= 400 \\10 \tan(\theta) + 400 \sec^2(\theta) \cdot \frac{d\theta}{dt} &= 0\end{aligned}$$

The first equation gives us $\theta = \pi/4$, and putting this into the second equation gives:

$$10 \cdot 1 + 400 \cdot 2 \cdot \frac{d\theta}{dt} = 0$$

Hence $\frac{d\theta}{dt} = \frac{-1}{80}$. That is, at that moment, the angle of elevation is decreasing at a rate of $\frac{1}{80}$ radians per second.

W134. If x units are produced, then the total cost is $C(x) = x^3 + 4x^2 + 60x + 200$ and the selling price per unit is $p(x) = 100 - 3x$. Find the level of production that maximizes the total profit.

Solution

We use the principle that profit is maximized when marginal cost and marginal revenue are equal. The total revenue is $R(x) = xp(x) = 100x - 3x^2$. Thus we have the following:

$$R'(x) = C'(x) \implies 100 - 6x = 3x^2 + 8x + 60 \implies 3x^2 + 14x - 40 = (3x + 20)(x - 2) = 0$$

Thus profit is maximized when $x = 2$. (We reject the solution $x = -20/3$ since the level of production must be non-negative.)

W135. Find the absolute extreme values of $f(x) = 3x^4 - 4x^3 - 12x^2$ on $[-2, 1]$.

Solution

We first find the critical numbers of f in the interval $(-2, 1)$. Since f is differentiable for all x , all critical numbers satisfy $f'(x) = 0$.

$$f'(x) = 12x^3 - 12x^2 - 24x = 12x(x - 2)(x + 1)$$

Hence the solutions to $f'(x) = 0$ are $x = -1$, $x = 0$, and $x = 2$. We ignore the critical number $x = 2$ since it does not lie in the interval $(-2, 1)$. Now we compare the critical values and the endpoint values.

x	-2	-1	0	1
$f(x)$	32	-5	0	-13

Hence the absolute minimum value is -13 and the absolute maximum value is 32 .

W136. Find the absolute extreme values of $f(x) = x^2(x + 5)^3$ on $[-6, 0]$.

Solution

We first find the critical numbers of f in the interval $(-6, 0)$. Since f is differentiable for all x , all critical numbers satisfy $f'(x) = 0$. Rather than expand the expression for $f(x)$, differentiate, and then solve $f'(x) = 0$ (which requires us to factor $f'(x)$), we will simply find the derivative of

f with product rule.

$$f'(x) = 2x \cdot (x+5)^3 + x^2 \cdot 3(x+5)^2 \cdot 1 = x(x+5)^2 \cdot (2(x+5) + 3x) = 5x(x+2)(x+5)^2$$

Hence the solutions to $f'(x) = 0$ are $x = -5$, $x = -2$, and $x = 0$. (It's okay that $x = 0$ is also an endpoint of the interval $[-6, 0]$.) Now we compare the critical values and the endpoint values.

x	-6	-5	-2	0
$f(x)$	-36	0	108	0

Hence the absolute minimum value is -36 and the absolute maximum value is 108 .

W137. Consider the function

$$f(x) = e^{-x^2/2}$$

Find where f is concave down and find where f is concave up. Then find all inflection points (x - and y - coordinates). Write "NONE" for your answer if appropriate.

Solution

The first two derivatives of f are

$$f'(x) = -xe^{-x^2/2} \quad , \quad f''(x) = (x^2 - 1)e^{-x^2/2}$$

Since f is twice-differentiable on its domain, the only second-order critical numbers are solutions to $f''(x) = 0$.

$$(x^2 - 1)e^{-x^2/2} = 0 \implies x^2 - 1 = 0 \implies x = \pm 1$$

We make a sign chart for $f''(x)$. Note that $e^{-x^2/2}$ is positive for all x . So we need only test the sign of $x^2 - 1$.

interval	test point	sign of f''	shape of f
$(-\infty, -1)$	$f''(-2) = 3 \cdot \oplus$	\oplus	concave up
$(-1, 1)$	$f''(0) = -1 \cdot \oplus$	\ominus	concave down
$(1, \infty)$	$f''(2) = 3 \cdot \oplus$	\oplus	concave up

Hence f is concave down on the interval $(-1, 1)$ and concave up on the intervals $(-\infty, -1)$ and $(1, \infty)$. There are points of inflection at $(-1, e^{-1/2})$ and $(1, e^{-1/2})$.

Acceptable answer: The function f is concave down on $[-1, 1]$ and concave up on $(-\infty, -1]$ and $[1, \infty)$. We may also say that f is concave up on $(-\infty, -1] \cup [1, \infty)$ or $(-\infty, -1) \cup (1, \infty)$.

W138. Consider the function

$$f(x) = \frac{1}{x^2 - 6x}$$

Find all vertical asymptotes of f . Then find where f is decreasing and find where f is increasing. Finally determine the x -coordinates of all local extrema of f (and classify them as either a local minimum or a local maximum). Write "NONE" for your answer if appropriate.

Solution

The domain of f is all real numbers except where $x^2 - 6x = 0$, or $x(x - 6) = 0$. Hence the only numbers not in the domain of f are $x = 0$ and $x = 6$. Since f is algebraic, we know that f is continuous on its domain, hence the only candidates for vertical asymptotes are the lines $x = 0$ and $x = 6$. Direct substitution of either $x = 0$ or $x = 6$ gives the undefined expression " $\frac{1}{0}$ ". So we know that all corresponding one-sided limits at $x = 0$ and $x = 6$ must be infinite. So both lines $x = 0$ and $x = 6$ are, indeed, vertical asymptotes.

For intervals of increase and local extrema, we examine the first derivative.

$$f'(x) = \frac{-(2x - 6)}{(x^2 - 6x)^2}$$

Since f is differentiable on its domain, the only first-order critical numbers are solutions to $f'(x) = 0$.

$$\frac{-(2x - 6)}{(x^2 - 6x)^2} = 0 \implies -(2x - 6) = 0 \implies x = 3$$

We make a sign chart for $f'(x)$. Recall that since $x = 0$ and $x = 6$ are not in the domain of f , we must include those numbers on our sign chart. (Why? Since there are vertical asymptotes at $x = 0$ and $x = 6$, $f'(x)$ might have different signs to the left and right of each of these x -values.)

interval	test point	sign of f'	shape of f
$(-\infty, 0)$	$f'(-1) = \frac{\ominus\ominus}{\oplus}$	\oplus	increasing
$(0, 3)$	$f'(1) = \frac{\ominus\ominus}{\oplus}$	\oplus	increasing
$(3, 6)$	$f'(5) = \frac{\ominus\oplus}{\oplus}$	\ominus	decreasing
$(6, \infty)$	$f'(7) = \frac{\ominus\oplus}{\oplus}$	\ominus	decreasing

Hence f is decreasing on the intervals $(3, 6)$ and $(6, \infty)$; and f is increasing on the intervals $(-\infty, 0)$ and $(0, 3)$. There is no local minimum, but there is a local maximum at $x = 3$.

Acceptable answer: The function f is decreasing on $[3, 6)$ and $(6, \infty)$; and f is increasing on $(-\infty, 0)$ and $(0, 3]$. We may also write each pair of intervals as a union: f is decreasing on $(3, 6) \cup (6, \infty)$ and f is increasing on $(-\infty, 0) \cup (0, 3)$. (Note that including 0 or 6 in any of these intervals is incorrect.)

W139. Calculate each limit.

(a) $\lim_{x \rightarrow 0} \left(\frac{\sin(x)^2}{\sin(2x^2)} \right)$

(b) $\lim_{x \rightarrow 1} \left(\frac{\ln(x^2 + 2) - \ln(3)}{x - 1} \right)$

Solution

(a) Substitution of $x = 0$ gives the indeterminate form " $\frac{0}{0}$ ". Using L'Hospital's Rule shows the following.

$$\lim_{x \rightarrow 0} \left(\frac{\sin(x)^2}{\sin(2x^2)} \right) \stackrel{H}{=} \lim_{x \rightarrow 0} \left(\frac{2 \sin(x) \cos(x)}{4x \cos(2x^2)} \right)$$

Rearranging the terms and using the fact that $\lim_{x \rightarrow 0} \left(\frac{\sin(x)}{x} \right) = 1$ gives us the following.

$$\lim_{x \rightarrow 0} \left(\frac{2 \sin(x) \cos(x)}{4x \cos(2x^2)} \right) = \lim_{x \rightarrow 0} \left(\frac{\sin(x)}{x} \cdot \frac{2 \cos(x)}{4 \cos(2x^2)} \right) = 1 \cdot \frac{2}{4} = \frac{1}{2}$$

(b) Substitution of $x = 1$ gives the indeterminate form " $\frac{0}{0}$ ". Using L'Hospital's Rule gives the following.

$$\lim_{x \rightarrow 1} \left(\frac{\ln(x^2 + 2) - \ln(3)}{x - 1} \right) \stackrel{H}{=} \lim_{x \rightarrow 1} \left(\frac{\frac{1}{x^2+2} \cdot 2x}{1} \right) = \frac{2}{3}$$

W140. A poster is to have a total area of 150 in^2 , which includes a central printed area, 1-inch margins at the bottom and sides, and a 2-inch margin at the top. What poster dimensions (in inches) will give the largest printed area? Use calculus to justify your answer.

You must demonstrate that your answers really are the optimal dimensions.

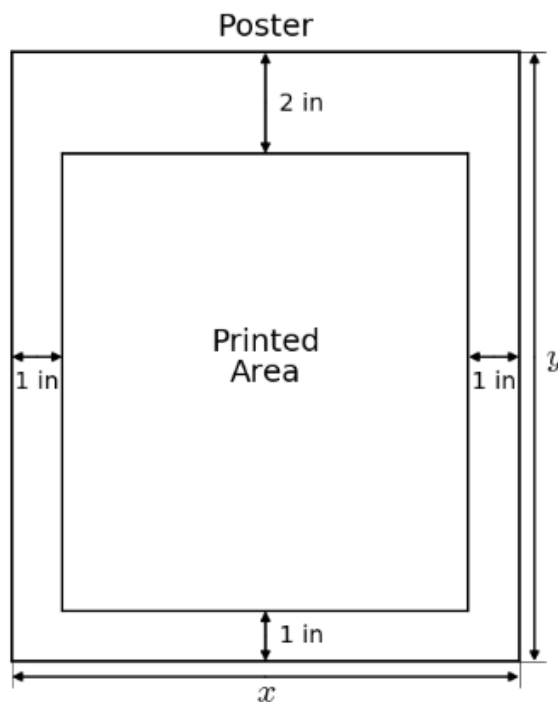

Solution

Let x and y be the width and height of the poster, as shown in the diagram. Then our objective is to find the absolute maximum value of the function

$$p(x, y) = (x - 2)(y - 3)$$

which corresponds to the area of the central printed region. The variables x and y are not independent, but rather satisfy the equation (or constraint) $xy = 150$ (total area is 150). Solving for y in the constraint gives $y = 150/x$, and so the area of the central printed region is given by the function

$$f(x) = p\left(x, \frac{150}{x}\right) = (x - 2)\left(\frac{150}{x} - 3\right) = 156 - 3x - \frac{300}{x}$$

Note that the problem requires that x be no smaller than 2 (the minimum width due to the horizontal margins) and y be no smaller than 3 (the minimum height due to the vertical margins). The condition $y \geq 3$ is equivalent to $\frac{150}{x} \geq 3$, or $x \leq 50$. Hence our goal is to find the absolute maximum value of

$$f(x) = 156 - 3x - \frac{300}{x}$$

on the interval $[2, 50]$. Since f is differentiable on this interval, the critical numbers are the solutions to $f'(x) = 0$.

$$0 = f'(x) = -3 + \frac{300}{x^2} \implies x^2 = 100 \implies x = \pm 10$$

(We ignore the critical number $x = -10$ since it is not in $[2, 50]$.) Checking the endpoint values and critical value, we get: $f(2) = 0$, $f(10) = 96$, and $f(50) = 0$. Hence the area of the printed region has an absolute maximum when $x = 10$ and $y = \frac{150}{10} = 15$.

Alternatively...

Instead of finding the precise interval of allowed x -values, we may observe that the allowed interval is some subinterval of $(0, \infty)$ since lengths must be positive. Observe that

$$f''(x) = \frac{-600}{x^3}$$

and $f''(x) < 0$ for $x > 0$. Hence $f(x)$ is concave down on $(0, \infty)$. So the only critical number $x = 10$ must give rise to a local (and hence absolute) maximum value.

(We may also instead use the first derivative test to determine that $x = 10$ gives a local (and hence absolute) maximum value.)

- W141.** A piece of cardboard that is 24 inches wide and 15 inches long is to be used to construct a box with an open top. To do this, congruent squares are cut from each corner of the cardboard, and the flaps are folded up and taped to form the sides of the box. What is the largest possible volume of such a box? Use calculus to justify your answer.

You must demonstrate that your answers really are the optimal dimensions.

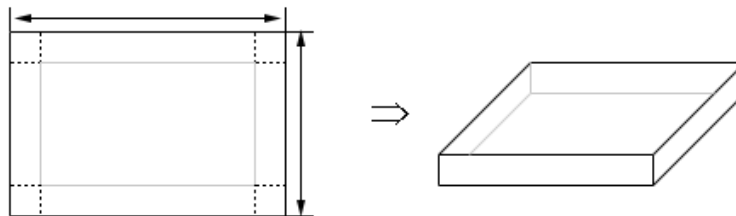

Solution

Let x be the length of the square that is cut out of each corner. Then the length of the top and bottom flaps is $24 - 2x$ and the length of the left and right flaps is $15 - 2x$. Note that the lengths of these flaps are the lengths of the base of the box. Since x is the width of each flap, x is also the height of the box. Thus the total volume of the box in terms of x is

$$V(x) = (24 - 2x)(15 - 2x)x = 4x^3 - 78x^2 + 360x$$

Note that the problem requires that the dimensions of the box remain non-negative. That is, we must have that $x \geq 0$, $24 - 2x \geq 0$, and $15 - 2x \geq 0$. Together, these three inequalities imply that x must satisfy $0 \leq x \leq 7.5$. (Note that we *do* allow the degenerate cases of $x = 0$ and $x = 7.5$. In both of these cases, the resulting “box” has zero volume, but this is mathematically okay and preferable!) Thus our goal is to find the absolute maximum value of $V(x)$ on the interval $[0, 7.5]$. Since $V(x)$ is differentiable for all x , the only critical numbers satisfy $V'(x) = 0$. The derivative $V'(x)$ satisfies:

$$V'(x) = 12x^2 - 156x + 360 = 12(x^2 - 13x + 30) = 12(x - 10)(x - 3)$$

Thus the only critical number of $V(x)$ is $x = 3$. (We must reject $x = 10$ since it lies outside the interval $[0, 7.5]$.) Now we use the closed, bounded interval method of Section 4.1 to verify that $x = 3$ does, indeed, give the maximum volume. Note that the endpoint values are both 0 (that is, $V(0) = V(7.5) = 0$). Thus, since $V(3)$ is clearly positive, $V(3)$ must be the absolute maximum value of $V(x)$ on $[0, 7.5]$.

Thus the largest possible volume is $V(3) = 3(24 - 6)(15 - 6) = 3(18)(9) = 486 \text{ in}^3$.

- W142.** Find the largest possible area of a rectangle whose base lies on the x -axis and whose upper vertices lie on the parabola $y = 6 - x^2$.

Solution

Let (x, y) be the coordinates of the upper right vertex of the rectangle. Then $y = 6 - x^2$ and the area of the rectangle is $A(x) = 2xy = 2x(6 - x^2) = 12x - 2x^3$. The allowed values of x range from $x = 0$ (degenerate case of line segment along y -axis) to $x = \sqrt{6}$ (degenerate case of line segment along x -axis). The critical numbers of $A(x)$ are found by solving $A'(x) = 12 - 6x^2 = 0$, and so the only critical number is $x = \sqrt{2}$. (We ignore the solution $x = -\sqrt{2}$ since it is not in the interval $[0, \sqrt{6}]$.) Observe that $A(0) = A(\sqrt{6}) = 0$ and $A(\sqrt{2}) = 8\sqrt{2}$. Hence $8\sqrt{2}$ is the maximum area.

- W143.** A car traveling north at 40 mi/hr and a truck traveling east at 30 mi/hr leave an intersection at the same time. At what rate will the distance between them be changing 4 hours later?

Solution

Let x be the truck's distance from the intersection and let y be the car's distance from the intersection. If L is the distance between the truck and the car, then $x^2 + y^2 = L^2$. Differentiating with respect to time t gives

$$2x \frac{dx}{dt} + 2y \frac{dy}{dt} = 2L \frac{dL}{dt}$$

We are given that $\frac{dx}{dt} = 30$ and $\frac{dy}{dt} = 40$. This implies that 4 hours after leaving the intersection, $x = 30 \cdot 4 = 120$ and $y = 40 \cdot 4 = 160$. At that time, $L = \sqrt{x^2 + y^2} = \sqrt{120^2 + 160^2} = 200$. Putting this altogether in the equation displayed above gives us

$$2 \cdot 120 \cdot 30 + 2 \cdot 160 \cdot 40 = 2 \cdot 200 \cdot \frac{dL}{dt}$$

So we find that $\frac{dL}{dt} = 50$. That is, the distance between the truck and car is increasing at a rate of 50 mi/hr.

- W144.** Find the absolute minimum and maximum of $f(x) = (6x + 1)e^{3x}$ on the interval $[-1000, 1000]$.

Solution

Since f is differentiable for all x , the only critical numbers are the solutions to $f'(x) = 0$.

$$0 = f'(x) = (6x + 1)e^{3x} \cdot 3 + 6 \cdot e^{3x} = 9e^{3x}(2x + 1)$$

Since $e^{3x} > 0$ for all x , the only critical number is $x = -\frac{1}{2}$. Now we check the endpoint values and critical values.

$$f(-1000) = -5999e^{-3000}$$

$$f(-1/2) = -2e^{-3/2}$$

$$f(1000) = 6001e^{3000}$$

The last of these values is the only positive value, and so $6001e^{3000}$ is the absolute maximum of f on the interval. To compare the other two values, we use the first derivative test. Observe that $f'(-1) = -9e^{-3} < 0$ and $f'(0) = 9 > 0$. Hence f is decreasing on $[-1000, -1/2]$ and increasing on $[-1/2, 1000]$. We thus conclude that $-2e^{-3/2}$ is a local (and hence global) minimum value of f on the interval.

- W145.** The marginal revenue of a certain product is $R'(x) = -9x^2 + 17x + 30$, where x is the level of production. Assume $R(0) = 0$. Find the market price that maximizes revenue.

Solution

Revenue is maximized if $R'(x) = -(9x + 10)(x - 3) = 0$, or if $x = 3$. (We ignore the solution $x = -10/9$ since x must be positive since it represents level of production.) Antidifferentiating $R'(x)$, we find that the revenue is $R(x) = -3x^3 + \frac{17}{2}x^2 + 30x + K$, for some unknown constant K . The assumption that $R(0) = 0$ implies that $K = 0$, whence $R(x) = -3x^3 + \frac{17}{2}x^2 + 30x$. Since $R(x) = xp(x)$, the market price is $p(x) = -3x^2 + \frac{17}{2}x + 30$. Hence the market price when revenue is maximized is $p(3) = 28.5$.

- W146.** Use linear approximation or differentials to estimate $(33.6)^{1/5}$.

Solution

Let $f(x) = x^{1/5}$ and consider the tangent line to f at $x = 32$.

$$f(32) = 32^{1/5} = 2$$

$$f'(x) = \frac{1}{5}x^{-4/5}$$

$$f'(32) = \frac{1}{5} \cdot 32^{-4/5} = \frac{1}{5} \cdot \frac{1}{16} = \frac{1}{80}$$

Hence the tangent line is $y = 2 + \frac{1}{80}(x - 32)$. The fundamental concept of linearization is that if x is close to 32, then the values of f should be approximately given by the values of y on the tangent line. Hence we have

$$(33.6)^{1/5} \approx 2 + \frac{1}{80}(33.6 - 32) = 2 + \frac{1.6}{80} = 2 + \frac{2}{100} = 2.02$$

W147. Consider the function f and its derivatives below.

$$f(x) = \frac{(x-1)^2}{(x+2)(x-4)} \quad , \quad f'(x) = \frac{-18(x-1)}{(x+2)^2(x-4)^2} \quad , \quad f''(x) = \frac{54((x-1)^2+3)}{(x+2)^3(x-4)^3}$$

Find the vertical and horizontal asymptotes of f . Then find where f is decreasing, where f is increasing, where f is concave down, and where f is concave up. Calculate the x -coordinates of all local minima, local maxima, and points of inflection.

Solution

vertical asymptote(s)	$x = -2, x = 4$
horizontal asymptote(s)	$y = 1$
where f is decreasing	$[1, 4), (4, \infty)$
where f is increasing	$(-\infty, -2), (-2, 1]$
x -coordinate(s) of local minima	NONE
x -coordinate(s) of local maxima	$x = 1$
where f is concave down	$(-2, 4)$
where f is concave up	$(-\infty, -2), (4, \infty)$
x -coordinate(s) of inflection point(s)	NONE

The derivatives of f are

$$f(x) = \frac{(x-1)^2}{(x+2)(x-4)} \quad , \quad f'(x) = \frac{-18(x-1)}{(x+2)^2(x-4)^2} \quad , \quad f''(x) = \frac{54((x-1)^2+3)}{(x+2)^3(x-4)^3}$$

(i) *Vertical asymptotes and horizontal asymptotes.*

Observe that f is continuous on its domain, but is undefined for $x = -2$ and $x = 4$. Hence our candidate vertical asymptotes are the lines $x = -2$ and $x = 4$. Indeed, direct substitution of either $x = -2$ or $x = 4$ into $f(x)$ gives the expression “ $\frac{\text{non-zero } \neq}{0}$ ”, which indicates that both one-sided limits are infinite. Hence the lines $x = -2$ and $x = 4$ are true vertical asymptotes.

As for the horizontal asymptotes we have the following. (After factoring out x^2 from numerator and denominator of $f(x)$.)

$$\lim_{x \rightarrow \pm\infty} f(x) = \lim_{x \rightarrow \pm\infty} \left(\frac{(1 - \frac{1}{x})^2}{(1 + \frac{2}{x})(1 - \frac{4}{x})} \right) = \frac{(1-0)^2}{(1+0)(1-0)} = 1$$

Hence the only horizontal asymptote is the line $y = 1$.

(ii) *Intervals of increase and local extrema.*

Since f is differentiable on its domain, the only first-order critical numbers are solutions to $f'(x) = 0$.

$$\frac{-18(x-1)}{(x+2)^2(x-4)^2} = 0 \implies x = 1$$

(iii) *Intervals of concavity and inflection points.*

We make a sign chart for $f'(x)$. Recall that we must include vertical asymptotes on our sign chart.

interval	test point	sign	shape
$(-\infty, -2)$	$f'(-3) = \frac{-18\ominus}{\oplus\oplus}$	\oplus	increasing
$(-2, 1)$	$f'(0) = \frac{-18\ominus}{\oplus\oplus}$	\oplus	increasing
$(1, 4)$	$f'(2) = \frac{-18\oplus}{\oplus\oplus}$	\ominus	decreasing
$(4, \infty)$	$f'(5) = \frac{-18\oplus}{\oplus\oplus}$	\ominus	decreasing

Hence f is decreasing on $[1, 4)$ and $(4, \infty)$; and increasing on $(-\infty, -2)$ and $(-2, 1]$.

(iv) *Sketch of graph.*

There is a local maximum at $x = 1$ but no local minimum.

Since f is twice-differentiable on its domain, the only second-order critical numbers are solutions to $f''(x) = 0$.

$$\frac{54((x-1)^2 + 3)}{(x+2)^3(x-4)^3} = 0 \implies \text{no solution}$$

We make a sign chart for $f''(x)$. Recall that we must include vertical asymptotes on our sign chart.

interval	test point	sign	shape
$(-\infty, -2)$	$f''(-3) = \frac{54\oplus}{\ominus\ominus}$	\oplus	concave up
$(-2, 4)$	$f''(0) = \frac{54\oplus}{\oplus\oplus}$	\ominus	concave down
$(4, \infty)$	$f''(5) = \frac{54\oplus}{\oplus\oplus}$	\oplus	concave up

Hence f is concave down on $(-2, 4)$; and concave up on $(-\infty, -2)$ and $(4, \infty)$. There are no points of inflection. Not required.

W148. For each part, calculate the limit or show it does not exist.

(a) $\lim_{x \rightarrow 2} \left(\frac{\sqrt{x+2} - \sqrt{2x}}{x^2 - 2x} \right)$

(b) $\lim_{x \rightarrow \infty} \left(1 + \frac{2}{x} \right)^{3x}$

(c) $\lim_{x \rightarrow 0} \left(\frac{\sin(5x) - 5x}{x^3} \right)$

Solution

- (a) Rationalize the numerator and cancel common factors. (L'Hospital's Rule is also applicable here, but might be more trouble than it's worth.)

$$\begin{aligned}\lim_{x \rightarrow 2} \left(\frac{\sqrt{x+2} - \sqrt{2x}}{x^2 - 2x} \right) &= \lim_{x \rightarrow 2} \left(\frac{-x + 2}{x(x-2)(\sqrt{x+2} + \sqrt{2x})} \right) \\ &= \lim_{x \rightarrow 2} \left(\frac{-1}{x(\sqrt{x+2} + \sqrt{2x})} \right) = \frac{-1}{2(2+2)} = -\frac{1}{8}\end{aligned}$$

- (b) Let L be the desired limit and consider $\ln(L)$.

$$\ln(L) = \lim_{x \rightarrow \infty} \ln \left[\left(1 + \frac{2}{x} \right)^{3x} \right] = \lim_{x \rightarrow \infty} \left(3x \ln \left[1 + \frac{2}{x} \right] \right) = \lim_{x \rightarrow \infty} \left(\frac{3 \ln \left[1 + \frac{2}{x} \right]}{\frac{1}{x}} \right)$$

We now have the indeterminate form " $\frac{\infty}{\infty}$ ", whence we may use L'Hospital's Rule.

$$\ln(L) \stackrel{H}{=} \lim_{x \rightarrow \infty} \left(\frac{3 \cdot \frac{1}{1 + \frac{2}{x}} \cdot \frac{-2}{x^2}}{\frac{-1}{x^2}} \right) = \lim_{x \rightarrow \infty} \left(\frac{6}{1 + \frac{2}{x}} \right) = \frac{6}{1+0} = 6$$

We have shown $\ln(L) = 6$, whence $L = e^6$.

- (c) Use L'Hospital's Rule repeatedly (each time verifying the indeterminate form " $\frac{0}{0}$ ").

$$\begin{aligned}\lim_{x \rightarrow 0} \left(\frac{\sin(5x) - 5x}{x^3} \right) &\stackrel{H}{=} \lim_{x \rightarrow 0} \left(\frac{5 \cos(5x) - 5}{3x^2} \right) \stackrel{H}{=} \lim_{x \rightarrow 0} \left(\frac{-25 \sin(5x)}{6x} \right) \\ &\stackrel{H}{=} \lim_{x \rightarrow 0} \left(\frac{-125 \cos(5x)}{6} \right) = -\frac{125}{6}\end{aligned}$$

W149. Find the absolute minimum and absolute maximum values of $f(x) = x^3 - 12x + 5$ on $[-5, 3]$.

Solution

The critical numbers of f are the solutions to $f'(x) = 3x^2 - 12 = 0$, or $x = -2$ and $x = 2$. Checking the endpoint values and critical values, we find the following: $f(-5) = -60$, $f(-2) = 21$, $f(2) = -11$, and $f(3) = -4$. Hence the absolute minimum of f on $[-5, 3]$ is -60 and the absolute maximum is 21 .

W150. An open cylindrical can (without top) must have a volume of $16\pi \text{ cm}^3$. The cost of the bottom is $\$2/\text{cm}^2$ and the cost of the curved surface is $\$1/\text{cm}^2$. Find the radius and height of the least expensive can. Justify that your answer does, in fact, give the minimum cost.

Hint: The volume of a cylinder is $\pi r^2 h$. The surface area of the curved surface is $2\pi r h$, and the surface area of the top or bottom is πr^2 .

Solution

Let r and h denote the radius and height of the can. The cost of the curved surface is $(2\pi rh) \cdot 1 = 2\pi rh$, and the cost of the bottom is $(\pi r^2) \cdot 2 = 2\pi r^2$. Hence the total cost of the can is

$$C(r, h) = 2\pi rh + 2\pi r^2 = 2\pi(rh + r^2)$$

The volume of the can must be 16π , whence r and h must satisfy the constraint $\pi r^2 h = 16\pi$. Solving for h shows that h must satisfy $h = \frac{16}{r^2}$. The total cost is thus a function of r alone.

$$f(r) = C\left(r, \frac{16}{r^2}\right) = 2\pi\left(r \cdot \frac{16}{r^2} + r^2\right) = 2\pi\left(\frac{16}{r} + r^2\right)$$

Our goal is to find the minimum value of $f(r)$ on the interval $(0, \infty)$. (The radius is allowed to take on any positive value, but $r = 0$ is not allowed since that would violate the volume constraint.) The critical numbers of f are solutions to $f'(r) = 0$.

$$0 = f'(r) = 2\pi\left(-\frac{16}{r^2} + 2r\right) \implies 16 = 2r^3 \implies r = 2$$

Now observe that $f''(r) = 2\pi\left(\frac{32}{r^3} + 2\right)$, which is positive for all $r > 0$. Hence $r = 2$ must give a relative minimum of f on $(0, \infty)$, and since $r = 2$ is the only critical number on this interval, $r = 2$ must give the absolute minimum of f on $(0, \infty)$. So the least expensive can has radius $r = 2$ and height $h = 4$ (both in centimeters).

W151. Use linear approximation or differentials to estimate $\sqrt[4]{78}$.

Solution

Let $f(x) = x^{1/4}$ and consider the tangent line to f at $x = 81$.

$$f(81) = (81)^{1/4} = 3$$

$$f'(x) = \frac{1}{4}x^{-3/4}$$

$$f'(81) = \frac{1}{4} \cdot (81)^{-3/4} = \frac{1}{108}$$

Hence the tangent line is $y = 3 + \frac{1}{108}(x - 81)$. The fundamental concept of linearization is that if x is close to 81, then the values of f should be approximately given by the values of y on the tangent line. Hence we have

$$(78)^{1/4} \approx 3 + \frac{1}{108}(78 - 81) = 3 - \frac{1}{36}$$

W152. The altitude of a triangle is increasing at a rate of 1 ft/min. while the area is increasing at a rate of 2 ft²/min. At what rate is the base of the triangle changing when the altitude is 10 ft. and the area is 100 ft²?

Solution

Let b , h , and A denote the base, altitude, and area of the triangle, respectively. Then $2A = bh$, and, after differentiating with respect to time t , we have the following.

$$2\frac{dA}{dt} = b\frac{dh}{dt} + \frac{db}{dt}h$$

We are given that $\frac{dh}{dt} = 1$ and $\frac{dA}{dt} = 2$. When $h = 10$ and $A = 100$, we find that $b = 20$. Putting this altogether in the equation displayed above gives us

$$2 \cdot 2 = 20 \cdot 1 + \frac{db}{dt} \cdot 10$$

So we find that $\frac{db}{dt} = -1.6$. That is, the base of the triangle is decreasing at a rate of 1.6 ft/min.

W153. Consider the function f and its derivatives below.

$$f(x) = \frac{24}{x^3 + 8} \quad , \quad f'(x) = \frac{-72x^2}{(x^3 + 8)^2} \quad , \quad f''(x) = \frac{288x(x^3 - 4)}{(x^3 + 8)^3}$$

Find the vertical and horizontal asymptotes of f . Then find where f is decreasing, where f is increasing, where f is concave down, and where f is concave up. Calculate the x -coordinates of all local minima, local maxima, and points of inflection.

Solution

vertical asymptote(s)	$x = -2$
horizontal asymptote(s)	$y = 0$
where f is decreasing	$(-\infty, -2) , (-2, \infty)$
where f is increasing	NONE
x -coordinate(s) of local minima	NONE
x -coordinate(s) of local maxima	NONE
where f is concave down	$(-\infty, -2) , [0, \sqrt[3]{4}]$
where f is concave up	$(-2, 0] , [\sqrt[3]{4}, \infty)$
x -coordinate(s) of inflection point(s)	$x = 0 , x = \sqrt[3]{4}$

The derivatives of f are

$$f(x) = \frac{24}{x^3 + 8} \quad , \quad f'(x) = \frac{-72x^2}{(x^3 + 8)^2} \quad , \quad f''(x) = \frac{288x(x^3 - 4)}{(x^3 + 8)^3}$$

(i) *Vertical asymptotes and horizontal asymptotes.*

Observe that f is continuous on its domain, but is undefined for $x = -2$. Hence our candidate vertical asymptotes is the line $x = -2$. Indeed, direct substitution of $x = -2$ into $f(x)$ gives the expression " $\frac{24}{0}$ ", which indicates that both one-sided limits are infinite. Hence the line $x = -2$ is a true vertical asymptote.

As for the horizontal asymptotes we have the following.

$$\lim_{x \pm \infty} f(x) = \lim_{x \pm \infty} \left(\frac{24}{x^3 + 8} \right) = \frac{24}{\infty} = 0$$

Hence the only horizontal asymptote is the line $y = 0$.

(ii) *Intervals of increase and local extrema.*

Since f is differentiable on its domain, the only first-order critical numbers are solutions to $f'(x) = 0$.

$$\frac{-72x^2}{(x^3 + 8)^2} = 0 \implies x = 0$$

(iii) *Intervals of concavity and inflection points.*

We make a sign chart for $f'(x)$. Recall that we must include vertical asymptotes on our sign chart.

interval	test point	sign	shape
$(-\infty, -2)$	$f'(-3) = \frac{-72 \oplus}{\oplus}$	\ominus	decreasing
$(-2, 0)$	$f'(-1) = \frac{-72 \oplus}{\oplus}$	\ominus	decreasing
$(0, \infty)$	$f'(1) = \frac{-72 \oplus}{\oplus}$	\ominus	decreasing

Hence f is decreasing on $(-\infty, -2)$ and $(-2, \infty)$; and increasing on no intervals.

(iv) *Sketch of graph.*

There is no local minimum and no local maximum. (*Note:* The portion of the graph of f near $x = 0$ is similar to the graph of $y = -x^3$ near $x = 0$.)

Since f is twice-differentiable on its domain, the only second-order critical numbers are solutions to $f''(x) = 0$.

$$\frac{288x(x^3 - 4)}{(x^3 + 8)^3} = 0 \implies x = 0 \text{ or } x = \sqrt[3]{4}$$

We make a sign chart for $f''(x)$. Recall that we must include vertical asymptotes on our sign chart.

interval	test point	sign	shape
$(-\infty, -2)$	$f''(-3) = \frac{288 \ominus \ominus}{\ominus}$	\ominus	concave down
$(-2, 0)$	$f''(-1) = \frac{288 \ominus \ominus}{\oplus}$	\oplus	concave up
$(0, \sqrt[3]{4})$	$f''(1) = \frac{288 \oplus \ominus}{\oplus}$	\ominus	concave down
$(\sqrt[3]{4}, \infty)$	$f''(2) = \frac{288 \oplus \oplus}{\oplus}$	\oplus	concave up

Hence f is concave down on $(-\infty, -2)$ and $[0, \sqrt[3]{4}]$; and concave up on $(-2, 0]$ and $[\sqrt[3]{4}, \infty)$. There are points of inflection at both $x = 0$ and $x = \sqrt[3]{4}$ since the concavity changes at those values of x and f is continuous there. Not required.

Unit #5 Review: Integration (5.1 – 5.3, 5.5)

Difficulty guide for this worksheet:

Core or Beyond Core: 154, 155, 156 (all parts except d), 158

Advanced: 156d

Removed from syllabus: 157

W154. Find each antiderivative or integral.

(a) $\int \frac{2x + \sqrt{x} - 1}{x} dx$

(c) $\int_0^1 e^x(1 + e^{-2x}) dx$

(b) $\int (2x + 3)^{12} dx$

(d) $\int_0^{\pi/2} (1 + \sin(x))^5 \cos(x) dx$

Solution

(a) $\int \frac{2x + \sqrt{x} - 1}{x} dx = \int (2 + x^{-1/2} - x^{-1}) dx = 2x + 2x^{1/2} - \ln|x| + C$

(b) Substitute $u = 2x + 3$ (whence $\frac{1}{2}du = dx$).

$$\int (2x + 3)^{12} dx = \int \frac{1}{2}u^{12} du = \frac{1}{26}u^{13} + C = \frac{1}{26}(2x + 3)^{13} + C$$

(c) Expand the integrand and then split into two integrals.

$$\int_0^1 e^x(1 + e^{-2x}) dx = \int_0^1 (e^x + e^{-x}) dx = \int_0^1 e^x dx + \int_0^1 e^{-x} dx$$

For the first integral, use fundamental theorem of calculus. For the second integral substitute $u = -x$ (whence $-du = dx$) and then use the fundamental theorem of calculus.

$$\begin{aligned} \int_0^1 e^x dx &= e^x \Big|_0^1 = e - 1 \\ \int_0^1 e^{-x} dx &= \int_0^{-1} (-e^u) du = -e^u \Big|_0^{-1} = -e^{-1} + 1 \end{aligned}$$

Adding the integrals gives a final answer of $e - e^{-1}$.

(d) Substitute $u = 1 + \sin(x)$ (whence $du = \cos(x) dx$).

$$\int_0^{\pi/2} (1 + \sin(x))^5 \cos(x) dx = \int_1^2 u^5 du = \frac{1}{6}u^6 \Big|_1^2 = \frac{2^6}{6} - \frac{1}{6} = \frac{21}{2}$$

W155. The parts of this question are not related.

(a) Find $F'(x)$ if $F(x) = \int_{-1}^x \frac{t^5}{3 + t^6} dt$.

(b) Find $\int_0^5 f(t) dt$ if $f(x) = \begin{cases} x & , x < 1 \\ \frac{1}{x} & , x \geq 1 \end{cases}$.

Solution

- (a) Use the second part of the fundamental theorem of calculus: $F'(x) = \frac{x^5}{3+x^6}$.
- (b) Split the integral into two integrals using the subdivision property. Then use the fundamental theorem of calculus for each integral.

$$\begin{aligned}\int_0^5 f(t) dt &= \int_0^1 f(t) dt + \int_1^5 f(t) dt = \int_0^1 t dt + \int_1^5 \frac{1}{t} dt \\ &= \left(\frac{1}{2} t^2 \Big|_0^1 \right) + \left(\ln(t) \Big|_1^5 \right) = \left(\frac{1}{2} - 0 \right) + (\ln(5) - \ln(1)) = \frac{1}{2} + \ln(5)\end{aligned}$$

W156. Find each antiderivative or integral.

(a) $\int t^2 \cos(1-t^3) dt$

(c) $\int_2^3 \frac{\ln(x)}{x} dx$

(b) $\int \sqrt{x-1} dx$

(d) $\int_0^{\ln(3)} e^{2x} \sqrt{e^{2x}-1} dx$

Solution

- (a) Substitute $u = 1 - t^3$ (whence $-\frac{1}{3} du = t^2 dt$).

$$\int t^2 \cos(1-t^3) dt = \int \left(-\frac{1}{3} \cos(u) \right) du = -\frac{1}{3} \sin(u) + C = -\frac{1}{3} \sin(1-t^3) + C$$

- (b) Substitute $u = x - 1$ (whence $du = dx$).

$$\int \sqrt{x-1} dx = \int u^{1/2} du = \frac{2}{3} u^{3/2} + C = \frac{2}{3} (x-1)^{3/2} + C$$

- (c) Substitute $u = \ln(x)$ (whence $du = \frac{1}{x} dx$).

$$\int_2^3 \frac{\ln(x)}{x} dx = \int_{\ln(2)}^{\ln(3)} u du = \frac{1}{2} u^2 \Big|_{\ln(2)}^{\ln(3)} = \frac{\ln(3)^2 - \ln(2)^2}{2}$$

- (d) Substitute $u = e^{2x} - 1$ (whence $\frac{1}{2} du = e^{2x} dx$).

$$\int_0^{\ln(3)} e^{2x} \sqrt{e^{2x}-1} dx = \int_0^8 \frac{1}{2} u^{1/2} du = \frac{1}{3} u^{3/2} \Big|_0^8 = \frac{8^{3/2}}{3}$$

W157. Estimate the area under the graph of $f(x) = x^2 + 5x$ from $x = 0$ to $x = 4$ using a Riemann sum with right endpoints and 4 rectangles. Simplify your answer.

Solution

The width of each rectangle is $\Delta x = \frac{4-0}{4} = 1$, and the x -coordinates of the right endpoints of the four rectangles are $x_1 = 1$, $x_2 = 2$, $x_3 = 3$, and $x_4 = 4$. Hence the desired Riemann sum is

given below.

$$\begin{aligned}R_4 &= \Delta x (f(x_1) + f(x_2) + f(x_3) + f(x_4)) = 1 \cdot (f(1) + f(2) + f(3) + f(4)) \\ &= (1 + 5) + (4 + 10) + (9 + 15) + (16 + 20) = 80\end{aligned}$$

W158. The marginal cost (in dollars) of a certain product is $C'(x) = 6x^2 + 30x + 200$. If it costs \$250 to produce 1 unit, how much does it cost to produce 10 units?

Solution

Antidifferentiating $C'(x)$ shows that $C(x) = 2x^3 + 15x^2 + 200x + K$, for some unknown constant K . The condition $C(1) = 250$ implies that $K = 33$, and so the cost function is $C(x) = 2x^3 + 15x^2 + 200x + 33$. Hence the cost of producing 10 units is $C(10) = 5533$ dollars.

3 Quizzes

3.1 Spring 2018

X1. Find an equation of the line whose slope is -3 and which passes through the point $(1, 4)$.

Solution

Point-slope form gives the equation as $y - 4 = -3(x - 1)$, equivalent to $y = -3x + 7$.

X2. Simplify the expression $\frac{x^3 - 4x}{x^3 - x^2 - 6x}$ as much as possible.

Solution

$$\frac{x^3 - 4x}{x^3 - x^2 - 6x} = \frac{x(x^2 - 4)}{x(x^2 - x - 6)} = \frac{x(x+2)(x-2)}{x(x-3)(x+2)} = \frac{x-2}{x-3}$$

X3. Write the expression $\frac{\sqrt{xy^3}}{(x^{2/3}y^{-5/2})^6}$ in the form $x^a y^b$.

Solution

$$\frac{\sqrt{xy^3}}{(x^{2/3}y^{-5/2})^6} = \frac{x^{1/2}y^{3/2}}{x^4y^{-15}} = x^{1/2-4}y^{3/2-(-15)} = x^{-7/2}y^{33/2}$$

X4. Let $f(x) = 3x^2$. Simplify the expression $\frac{f(x+h) - f(x)}{h}$ as much as possible.

Solution

$$\begin{aligned} \frac{f(x+h) - f(x)}{h} &= \frac{3(x+h)^2 - 3x^2}{h} = \frac{3(x^2 + 2xh + h^2) - 3x^2}{h} \\ &= \frac{3x^2 + 6xh + 3h^2 - 3x^2}{h} = \frac{6xh + 3h^2}{h} = 6x + 3h \end{aligned}$$

X5. Evaluate the expression $\log_6(9) + \log_6(4)$.

Solution

$$\log_6(9) + \log_6(4) = \log_6(36) = 2$$

X6. Let $f(x) = 5x + 1$. Evaluate $f^{-1}(1)$.

Solution

The number $f^{-1}(1)$ is the number x such that $f(x) = 1$. The equation $5x + 1 = 1$ has solution $x = 0$, so $f^{-1}(1) = 0$.

X7. Write the solution to the inequality $x^2 - 3x + 2 < 0$ using interval notation.

Solution

We have that $x^2 - 3x + 2 = (x - 1)(x - 2)$, thus the graph of $y = x^2 - 3x + 2$ is a parabola that opens upward and crosses the x -axis at $x = 1$ and $x = 2$. Hence $y < 0$ precisely when x lies between the two roots. Thus the solution to the inequality $x^2 - 3x + 2 < 0$ is $x \in (1, 2)$.

Alternatively, the inequality is equivalent to $(x - 1)(x - 2) < 0$. There are three possibilities to consider: $x < 1$, $1 < x < 2$, and $2 < x$. We find that $(x - 1)(x - 2) < 0$ only in the second case $1 < x < 2$, i.e., $x \in (1, 2)$ in interval notation.

X8. Find all values of θ in the interval $[0, 2\pi)$ such that $2 \sin(2\theta) = 1$.

Solution

We have that $\sin(2\theta) = \frac{1}{2}$, whose reference angle solution is $2\theta = \frac{\pi}{6}$. The sine is positive also in the second quadrant, whence there is an additional solution given by $2\theta = \frac{5\pi}{6}$. Periodicity then gives all possible solutions.

$$\theta = \frac{\pi}{12} + \pi n \quad , \quad \theta = \frac{5\pi}{12} + \pi n$$

where n is an integer. The only solutions that lie in the interval $[0, 2\pi)$ are

$$\theta = \frac{\pi}{12}, \frac{13\pi}{12}, \frac{5\pi}{12}, \frac{17\pi}{12}$$

X9. Find an equation of the line that passes through the point $(-\pi, 1)$ with slope $\sqrt{2}$.

Solution

$$y - 1 = \sqrt{2}(x + \pi)$$

X10. Find the center and radius of the circle described by the equation $x^2 - 6x + y^2 + 2y - 6 = 0$.

Solution

Add 6 to the equation and then complete the square in x and y separately. Adding 9 completes the square in x and adding 1 completes the square in y .

$$\begin{aligned} x^2 - 6x + y^2 + 2y &= -6 \\ (x^2 - 6x + 9) + (y^2 + 2y + 1) &= -6 + 9 + 1 \\ (x - 3)^2 + (y + 1)^2 &= 4 \end{aligned}$$

Hence the center is $(3, -1)$ and the radius is 2.

X11. Let $f(x) = \frac{1}{x}$. Simplify the difference quotient $\frac{f(x+h) - f(x)}{h}$ as much as possible.

Solution

$$\begin{aligned}\frac{f(x+h) - f(x)}{h} &= \frac{\frac{1}{x+h} - \frac{1}{x}}{h} = \frac{\frac{x-(x+h)}{x(x+h)}}{h} = \frac{x - (x+h)}{hx(x+h)} \\ &= \frac{x - x - h}{hx(x+h)} = \frac{-h}{hx(x+h)} = -\frac{1}{x(x+h)}\end{aligned}$$

X12. Evaluate the limits using the given graph.

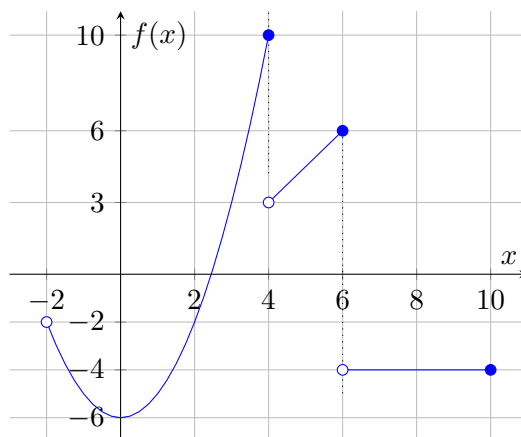

(a) $\lim_{x \rightarrow -2^+} f(x) =$

(c) $\lim_{x \rightarrow 4^+} f(x) =$

(b) $\lim_{x \rightarrow 4^-} f(x) =$

(d) $\lim_{x \rightarrow 6} f(x) =$

Solution

(a) $\lim_{x \rightarrow -2^+} f(x) = -2$

(b) $\lim_{x \rightarrow 4^-} f(x) = 10$

(c) $\lim_{x \rightarrow 4^+} f(x) = 3$

(d) $\lim_{x \rightarrow 6} f(x)$ does not exist

X13. Evaluate each of the following limits or show why it does not exist.

(a) $\lim_{x \rightarrow 2} \left(\frac{2x^2 - 3x - 2}{x^2 + 2x - 8} \right)$

(b) $\lim_{x \rightarrow 4} \left(\frac{3 - \sqrt{x+5}}{x-4} \right)$

Solution

(a) We have the following work.

$$\begin{aligned}\lim_{x \rightarrow 2} \left(\frac{2x^2 - 3x - 2}{x^2 + 2x - 8} \right) &= \lim_{x \rightarrow 2} \left(\frac{(x-2)(2x+1)}{(x-2)(x+4)} \right) \\ &= \lim_{x \rightarrow 2} \left(\frac{(x-2)(2x+1)}{(x-2)(x+4)} \right) \\ &= \lim_{x \rightarrow 2} \left(\frac{2x+1}{x+4} \right) \\ &= \frac{2(2)+1}{2+4} = \frac{5}{6}\end{aligned}$$

(b) We have the following work.

$$\begin{aligned}\lim_{x \rightarrow 4} \left(\frac{3 - \sqrt{x+5}}{x-4} \right) &= \lim_{x \rightarrow 4} \left(\frac{3 - \sqrt{x+5}}{x-4} \cdot \frac{3 + \sqrt{x+5}}{3 + \sqrt{x+5}} \right) \\ &= \lim_{x \rightarrow 4} \left(\frac{9 - (x+5)}{(x-4)(3 + \sqrt{x+5})} \right) \\ &= \lim_{x \rightarrow 4} \left(\frac{4-x}{(x-4)(3 + \sqrt{x+5})} \right) \\ &= \lim_{x \rightarrow 4} \left(-\frac{1}{(3 + \sqrt{x+5})} \right) \\ &= -\frac{1}{3 + \sqrt{4+5}} = -\frac{1}{6}\end{aligned}$$

X14. Consider the following function.

$$f(x) = \begin{cases} x^3 + 27 & , \quad x \leq -3 \\ \frac{x+3}{2 - \sqrt{1-x}} & , \quad -3 < x < 1 \\ 4 & , \quad x = 1 \\ x^2 + 2x - 1 & , \quad 1 < x \end{cases}$$

- (a) Find all points where f is discontinuous. *Be sure to give a full justification here.*
 (b) For each x -value you found in part (a), determine what value should be assigned to f , if any, to guarantee that f will be continuous there. Justify your answer.

(For example, if you claim f is discontinuous at $x = a$, then you should determine the value that should be assigned to $f(a)$, if any, to guarantee that f will be continuous at $x = a$.)

Solution

- (a) First note that $x = -3$ and $x = 1$ are suspicious points, and so we must check continuity there. For all other points, note that each piece individually is continuous on the given intervals. The first piece (x^3+27) and third piece (x^2+2x-1) are continuous on all intervals because they are polynomials. The second piece ($\frac{x+3}{2-\sqrt{1-x}}$), however, is not continuous on all intervals. Instead, we must require that $0 \leq 1-x$ (or $x \leq 1$) and $2 - \sqrt{1-x} \neq 0$ (or $x \neq -3$). But both of these conditions are satisfied on the indicated interval ($-3 < x \leq 1$). Now we check each suspicious point. To guarantee continuity at $x = a$, the left-limit, right-limit, and function value must all be equal at $x = a$.

- ($x = -3$):

$$\begin{aligned}\lim_{x \rightarrow -3^-} f(x) &= \lim_{x \rightarrow -3^-} (x^3 + 27) = (-3)^3 + 27 = 0 \\ \lim_{x \rightarrow -3^+} f(x) &= \lim_{x \rightarrow -3^+} \left(\frac{x+3}{2-\sqrt{1-x}} \right) \\ &= \lim_{x \rightarrow -3^+} \left(\frac{x+3}{2-\sqrt{1-x}} \cdot \frac{2+\sqrt{1-x}}{2+\sqrt{1-x}} \right) \\ &= \lim_{x \rightarrow -3^+} \left(\frac{(x+3)(2+\sqrt{1-x})}{4-(1-x)} \right) \\ &= \lim_{x \rightarrow -3^+} \left(\frac{(x+3)(2+\sqrt{1-x})}{x+3} \right) \\ &= \lim_{x \rightarrow -3^+} (2+\sqrt{1-x}) = 2 + \sqrt{1-(-3)} = 4 \\ f(-3) &= (x^3 + 27)|_{x=-3} = (-3)^3 + 27 = 0\end{aligned}$$

(Note that when calculating the right limit, we first rationalized the denominator, then canceled common factors, and finally substituted $x = -3$.) Since these three numbers are not all equal, f is discontinuous at $x = -3$.

- ($x = 1$):

$$\begin{aligned}\lim_{x \rightarrow 1^-} f(x) &= \lim_{x \rightarrow 1^-} \left(\frac{x+3}{2-\sqrt{1-x}} \right) = \frac{1+3}{2-\sqrt{1-1}} = 2 \\ \lim_{x \rightarrow 1^+} f(x) &= \lim_{x \rightarrow 1^+} (x^2 + 2x - 1) = 1^2 + 2(1) - 1 = 2 \\ f(1) &= 4\end{aligned}$$

Since these three numbers are not all equal, f is discontinuous at $x = 1$.

In summary, we have found that f is continuous for all real numbers except $x = -3$ and $x = 1$.

- (b) Since the one-sided limits at $x = -3$ are not equal, the two-sided limit $\lim_{x \rightarrow -3} f(x)$ does not exist. Hence it is not possible to assign a value to $f(-3)$ to make f continuous at $x = -3$. The one-sided limits at $x = 1$ are equal, and so $\lim_{x \rightarrow 1} f(x) = 2$. Hence if we assign $f(1)$ the value of 2, then we would have $\lim_{x \rightarrow 1} f(x) = f(1)$, which means f would be continuous at $x = 1$.

X15. Find all real solutions to the following equation.

$$\log_2(x) + \log_2(x-3) = 2$$

Solution

Combine the logarithms using the identity $\log_a(x) + \log_a(y) = \log_a(xy)$. Then undo the logarithms by exponentiation, and solve the resulting equation.

$$\begin{aligned}\log_2(x) + \log_2(x - 3) &= 2 \\ \log_2(x(x - 3)) &= 2 \\ x(x - 3) &= 2^2 \\ x^2 - 3x - 4 &= 0 \\ (x - 4)(x + 1) &= 0\end{aligned}$$

Hence the two candidate solutions are $x = 4$ and $x = -1$. Now check these candidates in the original equation.

The candidate $x = 4$ gives the purported equation

$$\log_2(4) + \log_2(1) = 2$$

Since $\log_2(4) = 2$ and $\log_2(1) = 0$, this is a true equation. Hence $x = 4$ is a solution.

The candidate $x = -1$ gives the purported equation

$$\log_2(-1) + \log_2(-4) = 2$$

This is nonsense since the domain of $\log_a(x)$ is strictly positive x . That is, we cannot compute the logarithm of a negative number. So $x = -1$ is not a solution.

In summary, the only solution to the given equation is $x = 4$.

X16. Let $f(x) = \frac{3-x}{1+x}$. Use the limit definition of derivative to calculate $f'(1)$.

If you simply quote a rule, you will receive zero credit. You must use the definition of derivative.

Solution

We start with the definition of derivative, then simplify and cancel.

$$\begin{aligned}f'(1) &= \lim_{h \rightarrow 0} \left(\frac{f(1+h) - f(1)}{h} \right) = \lim_{h \rightarrow 0} \left(\frac{\frac{3-(1+h)}{1+(1+h)} - 1}{h} \right) \\ &= \lim_{h \rightarrow 0} \left(\frac{\frac{2-h}{2+h} - 1}{h} \right) = \lim_{h \rightarrow 0} \left(\frac{(2-h) - (2+h)}{h(2+h)} \right) \\ &= \lim_{h \rightarrow 0} \left(\frac{-2h}{h(2+h)} \right) = \lim_{h \rightarrow 0} \left(\frac{-2}{2+h} \right) = \frac{-2}{2+0} = -1\end{aligned}$$

Hence $f'(1) = -1$.

X17. Let $g(x) = x^2 \ln(x)$. Find an equation of the tangent line at $x = e$.

Solution

First we compute $g'(x)$ by product rule.

$$g'(x) = x^2 \cdot \frac{1}{x} + 2x \cdot \ln(x) = x + 2x \ln(x)$$

Now observe that $g(e) = e^2 \ln(e) = e^2$ and $g'(e) = e + 2e \ln(e) = 3e$. Hence the tangent line has slope $3e$ and passes through the point (e, e^2) . So an equation of the tangent line is

$$y - e^2 = 3e(x - e)$$

X18. At a certain factory, the total cost (in dollars) of manufacturing q tables during the daily production run is

$$C(q) = 0.2q^2 + 10q + 900$$

From experience, it has been determined that approximately

$$q(t) = t^2 + 99t$$

tables are manufactured during the first t hours of a production run.

Make sure to indicate the units of your answer in each question below.

- Calculate $C'(50)$ and explain its precise meaning.
- Compute the rate at which the total manufacturing cost is changing with respect to time one hour after production begins.

Solution

- We have that $C'(q) = 0.4q + 10$, whence $C'(50) = 0.4 \cdot 50 + 10 = 20$ with units of \$/table (dollars per table). This means that at the time when 50 tables have already been produced, the cost of producing more tables is \$20 per table. (So if this rate were constant, then the 51st table would cost exactly \$20.)
- Note that when $t = 1$, the total number of tables manufactured is $q = 100$. So now by the chain rule we have

$$\begin{aligned} \left. \frac{dC}{dt} \right|_{t=1} &= \left(\left. \frac{dC}{dq} \right|_{q=100} \right) \cdot \left(\left. \frac{dq}{dt} \right|_{t=1} \right) \\ &= \left((0.4q + 10)|_{q=100} \right) \cdot \left((2t + 99)|_{t=1} \right) \\ &= (40 + 10) \cdot (2 + 99) = 50 \cdot 101 = 5050 \end{aligned}$$

So at one hour after production begins, the total manufacturing cost is changing at a rate of 5050 \$/hour (or \$5050 per hour).

X19. Calculate $\frac{d}{dx} (4x^3 e^{\sin(2x)})$. After computing the derivative, do not simplify your answer.

Solution

Use product rule. When differentiating the second factor, use chain rule twice.

$$\frac{d}{dx} (4x^3 e^{\sin(2x)}) = 4x^3 \cdot e^{\sin(2x)} \cdot \cos(2x) \cdot 2 + 12x^2 \cdot e^{\sin(2x)}$$

- X20.** At a certain factory, the total cost (in dollars) of manufacturing q tables during the daily production run is

$$C(q) = 0.2q^2 + 10q + 900$$

From experience, it has been determined that approximately

$$q(t) = t^2 + 99t$$

tables are manufactured during the first t hours of a production run.

Make sure to indicate the units of your answer in each question below.

- (a) Calculate $C'(50)$ and explain its precise meaning.
 (b) Compute the rate at which the total manufacturing cost is changing with respect to time one hour after production begins.

Solution

- (a) We have that $C'(q) = 0.4q + 10$, whence $C'(50) = 0.4 \cdot 50 + 10 = 20$ with units of \$/table (dollars per table). This means that at the time when 50 tables have already been produced, the cost of producing more tables is \$20 per table. (So if this rate were constant, then the 51st table would cost exactly \$20.)
 (b) Note that when $t = 1$, the total number of tables manufactured is $q = 100$. So now by the chain rule we have

$$\begin{aligned} \frac{dC}{dt} \Big|_{t=1} &= \left(\frac{dC}{dq} \Big|_{q=100} \right) \cdot \left(\frac{dq}{dt} \Big|_{t=1} \right) \\ &= \left((0.4q + 10) \Big|_{q=100} \right) \cdot \left((2t + 99) \Big|_{t=1} \right) \\ &= (40 + 10) \cdot (2 + 99) = 50 \cdot 101 = 5050 \end{aligned}$$

So at one hour after production begins, the total manufacturing cost is changing at a rate of 5050 \$/hour (or \$5050 per hour).

- X21.** Calculate $\frac{d}{dx} (4x^3 e^{\sin(2x)})$. After computing the derivative, do not simplify your answer.

Solution

Use product rule. When differentiating the second factor, use chain rule twice.

$$\frac{d}{dx} (4x^3 e^{\sin(2x)}) = 4x^3 \cdot e^{\sin(2x)} \cdot \cos(2x) \cdot 2 + 12x^2 \cdot e^{\sin(2x)}$$

- X22.** Use a linear approximation to estimate the value of $\frac{1}{\sqrt[4]{0.96}}$.

You must express your answer as a single exact rational number.

Solution

Let $f(x) = x^{-1/4}$ and $a = 1$. We will estimate the value of $(0.96)^{-1/4}$ using the tangent line to f at $x = 1$.

$$\begin{aligned} f(1) &= 1 \\ f'(x) &= -\frac{1}{4}x^{-5/4} \\ f'(1) &= -\frac{1}{4} \end{aligned}$$

The tangent line to f at $x = 1$ is

$$y = 1 - \frac{1}{4}(x - 1)$$

Substituting $x = 0.96$ gives the following.

$$\frac{1}{\sqrt[4]{0.96}} = f(0.96) \approx 1 - \frac{1}{4}(0.96 - 1) = 1 - \frac{1}{4}(-0.04) = 1.01$$

X23. Find the absolute maximum and absolute minimum values of $f(x) = \frac{10x}{x^2 + 1}$ on the interval $[0, 2]$.

Solution

The function f is differentiable on all intervals. So the only critical numbers are those x -values such that $f'(x) = 0$.

$$\begin{aligned} 0 &= f'(x) = \frac{(x^2 + 1)(10) - (10x)(2x)}{(x^2 + 1)^2} \\ 0 &= \frac{10 - 10x^2}{(x^2 + 1)^2} \\ 0 &= 10 - 10x^2 \\ 0 &= 1 - x^2 \end{aligned}$$

The only solution to the equation $1 - x^2 = 0$ in the interval $[0, 2]$ is $x = 1$. Checking the critical value and the endpoint values gives the following.

$$\begin{aligned} f(x) &= \frac{10x}{x^2 + 1} \\ f(0) &= 0 \\ f(1) &= \frac{10}{1 + 1} = 5 \\ f(2) &= \frac{20}{4 + 1} = 4 \end{aligned}$$

The maximum value of f on the interval $[0, 2]$ is 5 and the minimum value is 0.

X24. The function f and its derivatives are given below.

$$f(x) = \frac{x}{x^2 + 1}, \quad f'(x) = \frac{1 - x^2}{(x^2 + 1)^2}, \quad f''(x) = \frac{2x(x^2 - 3)}{(x^2 + 1)^3}$$

- Fill in the table below with information about the graph of $y = f(x)$. Write “NONE” as your answer if appropriate.
- Sketch the graph of $y = f(x)$ on the provided graph paper. Make sure to label the scales on the axes! For each relative extremum or inflection point, identify its coordinates and label the point “rel. min”, “rel. max”, or “infl. pt.” as appropriate.

Solution

- All work for the table is shown below.

domain of $f(x)$	$(-\infty, \infty)$
vertical asymptotes	none
horizontal asymptotes	$y = 0$
intervals where f is decreasing	$(-\infty, -1)$, $(1, \infty)$
intervals where f is increasing	$(-1, 1)$
x - and y -coordinates of local minima	$(-1, -\frac{1}{2})$
x - and y -coordinates of local maxima	$(1, \frac{1}{2})$
intervals where graph is concave down	$(-\infty, -\sqrt{3})$, $(0, \sqrt{3})$
intervals where graph is concave up	$(-\sqrt{3}, 0)$, $(\sqrt{3}, \infty)$
points of inflection	$(-\sqrt{3}, -\frac{\sqrt{3}}{4})$, $(0, 0)$, $(\sqrt{3}, \frac{\sqrt{3}}{4})$

- *domain*

$f(x)$ is a quotient of continuous functions whose denominator is never equal to 0

- *vertical asymptotes*

$f(x)$ is continuous for all real numbers

- *horizontal asymptotes*

Use L'Hospital's Rule to compute the limits.

$$\lim_{x \pm \infty} \left(\frac{x}{x^2 + 1} \right) \stackrel{H}{=} \lim_{x \pm \infty} \left(\frac{1}{2x} \right) = 0$$

- *intervals of decrease/increase*

The critical numbers of $f(x)$ are those x -values such that:

- $f'(x)$ does not exist: none
- $f'(x) = 0$: $x = -1$ or $x = 1$

Now we calculate a sign chart for f' .

interval	test point	sign	shape
$(-\infty, -1)$	$f'(-2) = \ominus$	\ominus	decreasing
$(-1, 1)$	$f'(0) = \oplus$	\oplus	increasing
$(1, \infty)$	$f'(2) = \ominus$	\ominus	decreasing

- *local extrema*

Since f goes from decreasing to increasing at $x = -1$, there is a local minimum at $(-1, -\frac{1}{2})$.

Since f goes from increasing to decreasing at $x = 1$, there is a local maximum at $(1, \frac{1}{2})$.

- *intervals of concavity*

The second-order critical numbers of $f(x)$ are those x -values such that:

- $f''(x)$ does not exist: none
- $f''(x) = 0$: $x = -\sqrt{3}$ or $x = 0$ or $x = \sqrt{3}$

Now we calculate a sign chart for f'' .

interval	test point	sign	shape
$(-\infty, -\sqrt{3})$	$f''(-2) = \frac{\ominus\oplus}{\oplus}$	\ominus	concave down
$(-\sqrt{3}, 0)$	$f''(-1) = \frac{\oplus\oplus}{\oplus}$	\oplus	concave up
$(0, \sqrt{3})$	$f''(1) = \frac{\oplus\ominus}{\oplus}$	\ominus	concave down
$(\sqrt{3}, \infty)$	$f''(2) = \frac{\oplus\oplus}{\oplus}$	\oplus	concave up

- *points of inflection*

Since the concavity changes at $x = -\sqrt{3}$, $x = 0$, and $x = \sqrt{3}$ (and f is continuous at each of those points), there are points of inflection at $(-\sqrt{3}, -\frac{\sqrt{3}}{4})$, $(0, 0)$, and $(\sqrt{3}, \frac{\sqrt{3}}{4})$.

(b) The graph of $f(x)$ is shown below.

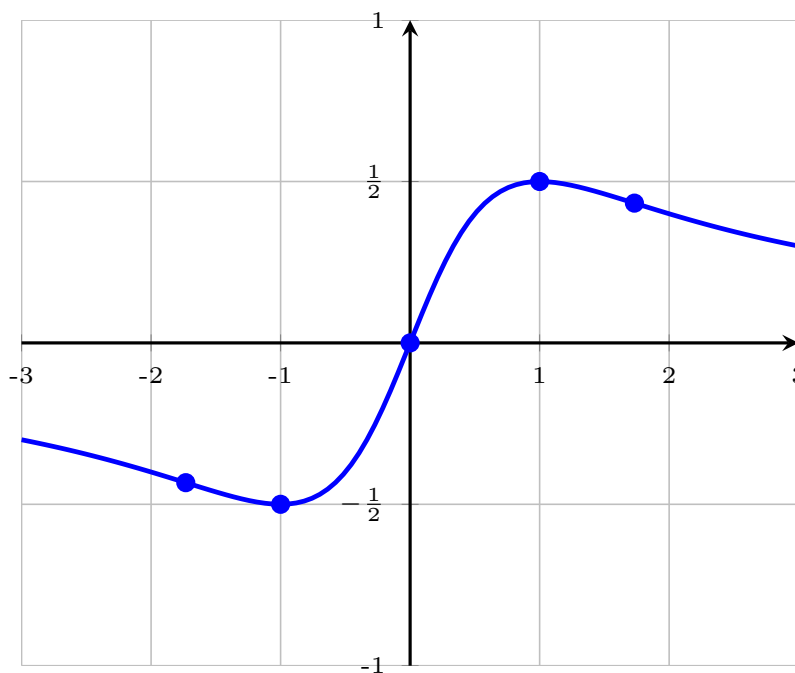

X25. Calculate the following limit or show it does not exist. Show all work.

$$\lim_{x \rightarrow 0} \left(\frac{x - \ln(1+x)}{1 - \cos(2x)} \right)$$

Solution

Substitution of $x = 0$ gives $\frac{0}{0}$, so we use L'Hospital's Rule.

$$\lim_{x \rightarrow 0} \left(\frac{x - \ln(1+x)}{1 - \cos(2x)} \right) \stackrel{H}{=} \lim_{x \rightarrow 0} \left(\frac{1 - \frac{1}{1+x}}{2 \sin(2x)} \right)$$

Substitution of $x = 0$ again gives $\frac{0}{0}$, so we use L'Hospital's Rule again.

$$\lim_{x \rightarrow 0} \left(\frac{1 - \frac{1}{1+x}}{2 \sin(2x)} \right) \stackrel{H}{=} \lim_{x \rightarrow 0} \left(\frac{\frac{1}{(1+x)^2}}{4 \cos(2x)} \right)$$

Substitution of $x = 0$ now simply gives the limit since the given function is continuous at $x = 0$.

$$\lim_{x \rightarrow 0} \left(\frac{\frac{1}{(1+x)^2}}{4 \cos(2x)} \right) = \frac{1}{4}$$

X26. The product of two positive numbers is 25. Find the smallest value of their sum.

Solution

We want to minimize the function $S(x, y) = x + y$ subject to the constraint $xy = 25$, whence $y = \frac{25}{x}$. Hence we want to minimize the function

$$S(x) = x + \frac{25}{x}$$

on the interval $(0, \infty)$.

Note that $S(x)$ is differentiable on $(0, \infty)$, so the only critical numbers of S are solutions to $S'(x) = 0$.

$$S'(x) = 1 - \frac{25}{x^2} = 0 \implies x^2 = 25 \implies x = 5$$

Now we check the nature of the critical number $x = 5$. Observe that

$$S''(x) = \frac{50}{x^3} > 0$$

for all $x > 0$. Hence the graph of $S(x)$ is concave up on the interval $(0, \infty)$. So $x = 5$ gives the global minimum of $S(x)$ on $(0, \infty)$.

Hence the smallest sum is $S(5) = 10$.

X27. An apartment complex has 200 units. When the monthly rent for each unit is \$1200, all units are occupied. Experience indicates that for each \$40-increase in rent, 10 units will become vacant. Each rented apartment costs the owners of the complex \$480 per month to maintain. What monthly rent should be charged to maximize the owner's profit?

Solution

Let x be the number of occupied units and let p be the monthly rent. Then p is a linear function of x (observe the crucial phrase “for each”). One point on this line is $(x_0, p_0) = (200, 1200)$ and the slope of the line is $m = \frac{\Delta p}{\Delta x} = \frac{40}{-10} = -4$. Hence we have

$$p = 1200 - 4(x - 200) = 2000 - 4x$$

Therefore the total revenue and total cost per month for the owners are

$$\begin{aligned} R(x) &= xp(x) = 2000x - 4x^2 \\ C(x) &= 480x \end{aligned}$$

Profit is maximized when marginal revenue is equal to marginal cost.

$$MR(x) = MC(x) \implies 2000 - 8x = 480 \implies x = 190$$

(We do not need to verify $x = 190$ gives the maximum profit for cost-revenue problems.) Thus the optimal rent is $p(190) = 1240$.

X28. Calculate the following antiderivatives.

(a) $\int (\cos(w) + 2 \sin(w) - 3e^w) dw$

(b) $\int \frac{3t^3 - \sqrt[3]{t} + 2t}{t^2} dt$

Solution

(a) Use familiar derivative rules backwards.

$$\int (\cos(w) + 2 \sin(w) - 3e^w) dw = \sin(w) - 2 \cos(w) - 3e^w + C$$

(b) Write the integrand as a sum of power functions, then antidifferentiate.

$$\int \frac{3t^3 - \sqrt[3]{t} + 2t}{t^2} dt = \int (3t - t^{-5/3} + 2t^{-1}) dt = \frac{3}{2}t^2 + \frac{3}{2}t^{-2/3} + 2 \ln(|t|) + C$$

X29. Let $f(x) = x^2 + 3x$ and let R be the region under the graph of $y = f(x)$ and above the interval $[0, 2]$ on the x -axis.

(a) Sketch the region R .

(b) Estimate the area of R using a Riemann sum with right endpoints and 4 rectangles.

Do not simplify your answer.

(c) Calculate the exact area of R .

Simplify your answer as much as possible.

Solution

(a) A sketch of the region is shown below.

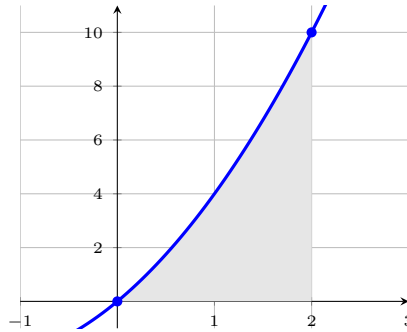

(b) The width of each rectangle is $\Delta x = \frac{2-0}{4} = 0.5$. The approximate area is calculated below.

Rectangle #	Width	Right endpoint (x -value)	Height (y -value)	Area
1	0.5	0.5	$(0.5)^2 + 3(0.5) = 1.75$	0.875
2	0.5	1	$1^2 + 3(1) = 4$	2
3	0.5	1.5	$1.5^2 + 3(1.5) = 6.75$	3.375
4	0.5	2	$2^2 + 3(2) = 10$	5

The approximate area is

$$A = 0.875 + 2 + 3.375 + 5 = 11.25$$

(c) The exact area is given by the following integral. (Use FTC part 1 to evaluate.)

$$\int_0^2 (x^2 + 3x) dx = \left(\frac{1}{3}x^3 + \frac{3}{2}x^2 \right) \Big|_0^2 = \frac{8}{3} + 6 = \frac{26}{3}$$

3.2 Spring 2020

X30. Evaluate each of the following limits or show why it does not exist.

(a) $\lim_{x \rightarrow 1} \left(\frac{\sqrt{7x+9} - 4}{x-1} \right)$

(b) $\lim_{x \rightarrow 5} \left(\frac{\frac{1}{5} - \frac{1}{x}}{\frac{x}{5} - \frac{5}{x}} \right)$

Solution

(a) Rationalize the numerator and cancel common factors.

$$\lim_{x \rightarrow 1} \left(\frac{\sqrt{7x+9} - 4}{x-1} \right) = \lim_{x \rightarrow 1} \left(\frac{7x+9-16}{(x-1)(\sqrt{7x+9}+4)} \right) = \lim_{x \rightarrow 1} \left(\frac{7}{\sqrt{7x+9}+4} \right) = \frac{7}{8}$$

(b) Multiply all terms by $5x$ (common denominator) and then cancel common factors.

$$\lim_{x \rightarrow 5} \left(\frac{\frac{1}{5} - \frac{1}{x}}{\frac{x}{5} - \frac{5}{x}} \right) = \lim_{x \rightarrow 5} \left(\frac{x-5}{x^2-25} \right) = \lim_{x \rightarrow 5} \left(\frac{1}{x+5} \right) = \frac{1}{10}$$

X31. Evaluate $\lim_{x \rightarrow 3} \left(\frac{3 - \sqrt{12-x}}{x-3} \right)$ or show that the limit does not exist.

Solution

Rationalize the numerator and cancel common factors.

$$\lim_{x \rightarrow 3} \left(\frac{3 - \sqrt{12-x}}{x-3} \right) = \lim_{x \rightarrow 3} \left(\frac{9 - (12-x)}{(x-3)(3 + \sqrt{12-x})} \right) = \lim_{x \rightarrow 3} \left(\frac{1}{3 + \sqrt{12-x}} \right) = \frac{1}{6}$$

X32. Find the values of a and b for which f is continuous for all x , or show that no such values of a and b exist. You must use proper calculus methods and clearly explain your work using limits.

$$f(x) = \begin{cases} ax^2 - bx - 6 & , \quad x < 3 \\ b & , \quad x = 3 \\ 10x - x^3 & , \quad x > 3 \end{cases}$$

Solution

Since each piece of f is continuous, we need only force continuity at $x = 3$. So we calculate the left-limit, right-limit, and function value at $x = 3$ and set these three quantities equal to each other.

$$\begin{aligned} \lim_{x \rightarrow 3^-} f(x) &= \lim_{x \rightarrow 3^-} (ax^2 - bx - 6) = 9a - 3b - 6 \\ \lim_{x \rightarrow 3^+} f(x) &= \lim_{x \rightarrow 3^+} (10x - x^3) = 3 \\ f(3) &= b \end{aligned}$$

From the right-limit and function value, we immediately find that $b = 3$. We must also have $9a - 3b - 6 = b$, whence $a = 2$.

X33. Let $f(x) = x^{-1} - 3x^{-2}$. Use the limit definition of the derivative to calculate $f'(1)$. (If you simply use shortcut rules, you will receive no credit.)

Solution

We start with the definition of the derivative, multiply all terms by the common denominator $(1+h)^2$, cancel common factors, and then substitute $h = 0$.

$$\begin{aligned} f'(1) &= \lim_{h \rightarrow 0} \left(\frac{f(1+h) - f(1)}{h} \right) = \lim_{h \rightarrow 0} \left(\frac{\frac{1}{1+h} - \frac{3}{(1+h)^2} - (-2)}{h} \right) \\ &= \lim_{h \rightarrow 0} \left(\frac{1+h-3+2(1+h)^2}{h(1+h)^2} \right) = \lim_{h \rightarrow 0} \left(\frac{1+h-3+2+4h+2h^2}{h(1+h)^2} \right) \\ &= \lim_{h \rightarrow 0} \left(\frac{h(5+2h)}{h(1+h)^2} \right) = \lim_{h \rightarrow 0} \left(\frac{5+2h}{(1+h)^2} \right) = \frac{5+0}{(1+0)^2} = 5 \end{aligned}$$

X34. Let $f(x) = \frac{50e^x}{x^2 + 1}$. Find an equation of the line tangent to the graph of $y = f(x)$ at $x = 3$.

Solution

The tangent line passes through the point $(3, f(3)) = (3, 5e^3)$, and its slope is $f'(3)$. Quotient rule gives:

$$f'(x) = \frac{50e^x(x^2 + 1) - 50e^x(2x)}{(x^2 + 1)^2} = \frac{50e^x(x^2 - 2x + 1)}{(x^2 + 1)^2}$$

Hence $f'(3) = 2e^3$, and so an equation of the tangent line is

$$y - 5e^3 = 2e^3(x - 3)$$

X35. For each part, find $f'(x)$. After computing the derivative, do not simplify your answer.

(a) $f(x) = \sqrt{\tan(x^3)}$

(b) $f(x) = x^{3/4} \ln(\sin(x) + x + e^3)$

Solution

(a) Use chain rule twice.

$$f'(x) = \frac{1}{2} (\tan(x^3))^{-1/2} \cdot \sec(x^3)^2 \cdot 3x^2$$

(b) Use product rule. On the second factor, use chain rule.

$$f'(x) = \frac{3}{4} x^{-1/4} \ln(\sin(x) + x + e^3) + x^{3/4} \cdot \frac{1}{\sin(x) + x + e^3} \cdot (\cos(x) + 1)$$

X36. Let $f(x) = x^{12}e^{5-3x}$. Find the x -coordinate of each point at which the graph of $y = f(x)$ has a horizontal tangent line.

Solution

We seek all solutions to the equation $f'(x) = 0$. Using product rule and chain rule, we have

$$f'(x) = 12x^{11}e^{5-3x} + x^{12}e^{5-3x} \cdot (-3) = x^{11}e^{5-3x}(12 - 3x)$$

Recall that $e^z > 0$ for all z . So the solutions to $f'(x) = 0$ are $x = 0$ and $x = 4$.

X37. Use a linear approximation to estimate the value of $(2.01)^5 - 5 \cdot (2.01)^3 + 9$. Write your answer as an exact decimal or as a fraction of integers.

Solution

We put $f(x) = x^5 - 5x^3 + 9$ and note that we want to estimate $f(2.01)$. We use the tangent line at $x = 2$. Observe that $f(2) = 1$ and $f'(x) = 5x^4 - 15x^2$, so that $f'(2) = 20$. Hence our tangent line approximation is

$$f(x) \approx 1 + 20(x - 2)$$

and this approximation is valid as long as x is close to 2. Hence we have

$$f(2.01) \approx 1 + 20(0.01) = 1.2$$

X38. The total cost of producing x units is $C(x) = 10x^3 + 500x^2 + 1000x + 24000$.

- Write a numerical expression equal to the exact cost of the 11th unit.
- Use marginal analysis to estimate the cost of the 11th unit. Write your answer as an exact decimal or as a fraction of integers.

Solution

(a) $C(11) - C(10)$

- (b) We use the standard approximation $MC(x) = C(x+1) - C(x) \approx C'(x)$, and so we estimate $MC(10) \approx C'(10)$.

$$C'(x) = 30x^2 + 1000x + 1000 \implies MC(10) \approx C'(10) = 14,000$$

X39. Find an equation of the line tangent to the graph of $xe^y = x^3 + (y - 1)^2 - 1$ at the point $(0, 2)$.

Solution

Implicitly differentiate with respect to x .

$$1 \cdot e^y + x \cdot e^y \cdot \frac{dy}{dx} = 3x^2 + 2(y - 1) \cdot \frac{dy}{dx}$$

Now substitute the given point (i.e., $x = 0$ and $y = 2$), and solve for $\frac{dy}{dx}$ to find the slope of the tangent line.

$$e^2 + 0 = 0 + 2 \cdot 1 \cdot \frac{dy}{dx}$$

Hence the slope of the tangent line is $e^2/2$, and an equation of the tangent line is

$$y - 2 = \frac{e^2}{2}x$$

- X40.** The image of a certain rectangle of area 30 cm^2 is changing in such a way that its length is decreasing at a rate of 2 cm/sec . and its area remains constant. At what rate is its width changing when its length is 6 cm ?

Solution

Let L and W be the length and width of the rectangle, respectively. Then the equation $LW = 30$ holds for all time, and, upon implicitly differentiating with respect to time, we also have

$$\frac{dL}{dt}W + L\frac{dW}{dt} = 0$$

At the specific time of interest, we have $\frac{dL}{dt} = -2$ and $L = 6$, and we want to find $\frac{dW}{dt}$. Substituting these values into our equations gives:

$$\begin{aligned} 6W &= 30 \\ -2W + 6\frac{dW}{dt} &= 0 \end{aligned}$$

From the first equation we get $W = 5$ and putting this into the second equation gives $\frac{dW}{dt} = \frac{5}{3}$. Hence the width is increasing at a rate of $5/3 \text{ cm/sec}$.

- X41.** Let $f(x) = 3x^2 - 5$. Use the limit definition of derivative to find $f'(x)$.

Solution

We start with the definition of the derivative, expand all terms, cancel common factors, and then substitute $h = 0$.

$$\begin{aligned} f'(x) &= \lim_{h \rightarrow 0} \left(\frac{f(x+h) - f(x)}{h} \right) = \lim_{h \rightarrow 0} \left(\frac{3(x+h)^2 - 5 - (3x^2 - 5)}{h} \right) \\ &= \lim_{h \rightarrow 0} \left(\frac{3x^2 + 6xh + 3h^2 - 5 - 3x^2 + 5}{h} \right) = \lim_{h \rightarrow 0} \left(\frac{h(6x + 3h)}{h} \right) \\ &= \lim_{h \rightarrow 0} (6x + 3h) = 6x \end{aligned}$$

- X42.** For each part, calculate the limit or show that it does not exist. If the limit is infinite, your answer should be “ $+\infty$ ” or “ $-\infty$ ”.

(a) $\lim_{x \rightarrow e} \left(\frac{1 - \ln(x)}{x^2 \ln(x) - e^2} \right)$

(b) $\lim_{x \rightarrow 2^+} \left(\frac{\cos(\pi x)}{x^2 - 6x + 8} \right)$

Solution

(a) Direct substitution of $x = e$ gives $\frac{0}{0}$, so we may use L'Hospital's Rule.

$$\lim_{x \rightarrow e} \left(\frac{1 - \ln(x)}{x^2 \ln(x) - e^2} \right) \stackrel{H}{=} \lim_{x \rightarrow e} \left(\frac{-\frac{1}{x}}{2x \ln(x) + x} \right) = \frac{-\frac{1}{e}}{2e \cdot 1 + e} = -\frac{1}{3e^2}$$

(b) Direct substitution of $x = 2$ gives $\frac{1}{0}$, and so the one-sided limit is infinite. The problem is reduced to a sign analysis. Note that if $x \rightarrow 2^+$, the numerator remains positive since $\cos(\pi x) \rightarrow 1 > 0$. The denominator may be factored as $x^2 - 6x + 8 = (x - 2)(x - 4)$. We note that as $x \rightarrow 2^+$, we may assume x is close to 2 and $x > 2$. Hence $x - 2 > 0$ and $x - 4 < 0$. Putting this altogether, we have

$$\lim_{x \rightarrow 2^+} \left(\frac{\cos(\pi x)}{(x - 2)(x - 4)} \right) = \frac{\oplus}{\oplus \ominus} \infty = -\infty$$

X43. Determine where $f(x)$ is continuous. Write your answer using interval notation.

$$f(x) = \begin{cases} 4x^2 - 10 & , \quad x < -1 \\ 6 \sin(\pi x/2) & , \quad -1 \leq x \leq 4 \\ x - 4^{x-3} & . \quad x > 4 \end{cases}$$

Solution

Observe that f is clearly continuous for all x except possibly $x = -1$ or $x = 4$. For these transition points, we check whether the corresponding left-limit, right-limit, and function value are equal. For $x = -1$ we have:

$$\begin{aligned} \lim_{x \rightarrow -1^-} f(x) &= \lim_{x \rightarrow -1^-} (4x^2 - 10) = 4 - 10 = -6 \\ \lim_{x \rightarrow -1^+} f(x) &= \lim_{x \rightarrow -1^+} (6 \sin(\pi x/2)) = 6 \cdot (-1) = -6 \\ f(-1) &= 6 \sin(\pi x/2)|_{x=-1} = 6 \cdot (-1) = -6 \end{aligned}$$

Since these three values are all equal, f is continuous at $x = -1$. For $x = 4$ we have:

$$\begin{aligned} \lim_{x \rightarrow 4^-} f(x) &= \lim_{x \rightarrow 4^-} (6 \sin(\pi x/2)) = 6 \cdot 0 = 0 \\ \lim_{x \rightarrow 4^+} f(x) &= \lim_{x \rightarrow 4^+} (x - 4^{x-3}) = 4 - 4^1 = 0 \\ f(4) &= 6 \sin(\pi x/2)|_{x=4} = 6 \cdot 0 = 0 \end{aligned}$$

Since these three values are all equal, f is continuous at $x = 4$. Hence the final answer is that f is continuous on $(-\infty, \infty)$.

X44. Use a linear approximation to estimate $\sqrt{14}$. Write your answer as an exact decimal or as a fraction of integers.

Solution

We put $f(x) = \sqrt{x}$ and note that we want to estimate $f(14)$. We use the tangent line at $x = 16$. Observe that $f(16) = 4$ and $f'(16) = \frac{1}{2}x^{-1/2}$, so that $f'(16) = \frac{1}{8}$. Hence our tangent line

approximation is

$$\sqrt{x} \approx 4 + \frac{1}{8}(x - 16)$$

and this approximation is valid if x is close to 16. Hence we have

$$\sqrt{14} \approx 4 + \frac{1}{8}(14 - 16) = \frac{15}{4} = 3.75$$

3.3 Summer 2022

X45. Find all solutions to the given equation.

$$2x^{5/2} + x^{3/2} + x^{1/2} = 0$$

Solution

We first factor out $x^{1/2}$ from the left-hand side.

$$x^{1/2} (2x^2 + x + 1) = 0$$

Thus either $x^{1/2} = 0$ (whence $x = 0$) or $2x^2 + x + 1 = 0$. However, the discriminant of this quadratic is

$$\Delta = 1^2 - 4 \cdot 2 \cdot 1 = -7 < 0$$

Since the discriminant is negative, the equation $2x^2 + x + 1 = 0$ has no (real) solution. Thus the only solution of the original equation is $x = 0$.

X46. Simplify the expression; assume $x \neq -10$.

$$\frac{x^3 + 10x^2}{\sqrt{15-x} - 5}$$

Solution

We rationalize the denominator, and then cancel common factors.

$$\begin{aligned} \frac{x^3 + 10x^2}{\sqrt{15-x} - 5} \cdot \frac{\sqrt{15-x} + 5}{\sqrt{15-x} + 5} &= \frac{(x^3 + 10x^2)(\sqrt{15-x} + 5)}{15 - x - 25} \\ &= \frac{x^2(x + 10)(\sqrt{15-x} + 5)}{-(x + 10)} \\ &= -x^2(\sqrt{15-x} + 5) \end{aligned}$$

X47. Simplify the expression; assume any common factors are non-zero.

$$\frac{\frac{x-1}{x+1} + \frac{6}{x}}{\frac{2}{x^2+x} + \frac{1}{x+1}}$$

Solution

Since $x^2 + x = x(x + 1)$, we see that the LCD of all terms is $x^2 + x$. So we multiply all terms by that LCD. Then we expand, factor, and cancel common factors.

$$\frac{\frac{x-1}{x+1} + \frac{6}{x}}{\frac{2}{x^2+x} + \frac{1}{x+1}} \cdot \frac{x(x+1)}{x(x+1)} = \frac{(x-1)x + 6(x+1)}{2 + 1 \cdot x} = \frac{x^2 + 5x + 6}{x + 2} = \frac{(x+2)(x+3)}{x+2} = x + 3$$

X48. Calculate the following limit or show that it does not exist.

$$\lim_{x \rightarrow 9} \left(\frac{x^3 - 81x}{(x-4)^2 - 25} \right)$$

Solution

Expand, factor, and cancel common factors.

$$\begin{aligned}\lim_{x \rightarrow 9} \left(\frac{x^3 - 81x}{(x-4)^2 - 25} \right) &= \lim_{x \rightarrow 9} \left(\frac{x(x^2 - 81)}{x^2 - 8x - 9} \right) = \lim_{x \rightarrow 9} \left(\frac{x(x-9)(x+9)}{(x-9)(x+1)} \right) \\ &= \lim_{x \rightarrow 9} \left(\frac{x(x+9)}{x+1} \right) = \frac{9 \cdot 18}{10} = 16.2\end{aligned}$$

X49. Calculate the following limit or show that it does not exist.

$$\lim_{x \rightarrow 1} \left(\frac{\sqrt{x+3} - 2}{x-1} \right)$$

Solution

Rationalize the numerator. Then cancel common factors.

$$\begin{aligned}\lim_{x \rightarrow 1} \left(\frac{\sqrt{x+3} - 2}{x-1} \right) &= \lim_{x \rightarrow 1} \left(\frac{\sqrt{x+3} - 2}{x-1} \cdot \frac{\sqrt{x+3} + 2}{\sqrt{x+3} + 2} \right) = \lim_{x \rightarrow 1} \left(\frac{x+3-4}{(x-1)(\sqrt{x+3} + 2)} \right) \\ &= \lim_{x \rightarrow 1} \left(\frac{x-1}{(x-1)(\sqrt{x+3} + 2)} \right) = \lim_{x \rightarrow 1} \left(\frac{1}{\sqrt{x+3} + 2} \right) = \frac{1}{\sqrt{4} + 2} = \frac{1}{4}\end{aligned}$$

X50. Calculate $\lim_{x \rightarrow 0} f(x)$ or show the limit does not exist, where $f(x)$ is the function given below. Your work must be coherent and clearly explain your answer.

$$f(x) = \begin{cases} 10e^x & x < 0 \\ 7 & x = 0 \\ \frac{\sin(10x)}{x} & x > 0 \end{cases}$$

Solution

Since $x = 0$ is a transition point of the piecewise-defined function f , we examine the one-sided limits.

$$\begin{aligned}\lim_{x \rightarrow 0^-} f(x) &= \lim_{x \rightarrow 0^-} (10e^x) = 10e^0 = 10 \\ \lim_{x \rightarrow 0^+} f(x) &= \lim_{x \rightarrow 0^+} \left(\frac{\sin(10x)}{x} \right) = \lim_{x \rightarrow 0^+} \left(\frac{\sin(10x)}{10x} \cdot 10 \right) = 1 \cdot 10 = 10\end{aligned}$$

Since the left- and right-limits at $x = 0$ are both equal to 10, we find that $\lim_{x \rightarrow 0} f(x) = 10$.

X51. Calculate all of the vertical and horizontal asymptotes of $f(x) = \frac{x^2 - 100}{10x - x^2}$.

Then find the two one-sided at $x = a$, where $x = a$ is the leftmost vertical asymptote of f .

Solution

First we calculate the horizontal asymptotes.

$$\lim_{x \rightarrow \pm\infty} f(x) = \lim_{x \rightarrow \pm\infty} \left(\frac{x^2 \left(1 - \frac{100}{x^2}\right)}{x^2 \left(\frac{10}{x} - 1\right)} \right) = \lim_{x \rightarrow \pm\infty} \left(\frac{1 - \frac{100}{x^2}}{\frac{10}{x} - 1} \right) = \frac{1 - 0}{0 - 1} = -1$$

Hence the only horizontal asymptote of f is the line $y = -1$.

For vertical asymptotes, we see that $10x - x^2 = 0$ has solutions $x = 0$ and $x = 10$. However, we have:

$$\lim_{x \rightarrow 10} f(x) = \lim_{x \rightarrow 10} \left(\frac{(x - 10)(x + 10)}{-x(x - 10)} \right) = \lim_{x \rightarrow 10} \left(\frac{x + 10}{-x} \right) = -2$$

Since this limit is finite, we see that $x = 10$ is not a vertical asymptote. However, we also see that $x = 0$ is, indeed, a vertical asymptote since direct substitution of $x = 0$ into $\frac{x+10}{-x}$ gives “ $\frac{\text{nonzero } \neq}{0}$ ”. This also means each of the one-sided limits at $x = 0$ is infinite.

We now compute the corresponding one-sided limits. Note that as $x \rightarrow 0$, the expression $x + 10$ is positive (tends to 10). However, the expression $-x$ stays positive as $x \rightarrow 0^-$ and negative as $x \rightarrow 0^+$. Hence we have:

$$\begin{aligned} \lim_{x \rightarrow 0^-} f(x) &= \lim_{x \rightarrow 0^-} \left(\frac{x + 10}{-x} \right) = \frac{10}{0^+} = +\infty \\ \lim_{x \rightarrow 0^+} f(x) &= \lim_{x \rightarrow 0^+} \left(\frac{x + 10}{-x} \right) = \frac{10}{0^-} = -\infty \end{aligned}$$

X52. If $f(x)$ is not defined at $x = a$, then which of the following must be true?

- (a) $\lim_{x \rightarrow a} f(x)$ cannot exist
- (b) $\lim_{x \rightarrow a^+} f(x)$ must be infinite (either $+\infty$ or $-\infty$)
- (c) $\lim_{x \rightarrow a} f(x)$ could be 0
- (d) none of the above

Solution

Choice (c).

The function value $f(a)$ is independent of $\lim_{x \rightarrow a} f(x)$. The function value is irrelevant when computing the limit. For instance, let $f(x) = \frac{x^2}{x}$. Then $f(x)$ is not defined at $x = 0$, but $\lim_{x \rightarrow 0} f(x) = 0$. So this limit could be 0 even if $f(a)$ is undefined.

X53. If $\lim_{x \rightarrow a^-} f(x) = \lim_{x \rightarrow a^-} g(x) = 0$, then which of the following is true about $\lim_{x \rightarrow a^-} \frac{f(x)}{g(x)}$?

- (a) The limit does not exist, and is not infinite.
- (b) The limit is infinite (either $+\infty$ or $-\infty$).
- (c) The limit must exist.
- (d) There is not enough information to say anything about the limit's value.

Solution

Choice (d).

The limit $\lim_{x \rightarrow a} \frac{f(x)}{g(x)}$ has the indeterminate form “ $\frac{0}{0}$ ”, which gives no information on the value of the limit or even whether the limit exists. For instance, consider each of the following limits:

$$\lim_{x \rightarrow 0^-} \left(\frac{x}{x} \right) \quad \lim_{x \rightarrow 0^-} \left(\frac{x^2}{x} \right) \quad \lim_{x \rightarrow 0^-} \left(\frac{x}{x^2} \right)$$

Then each of these limits has the indeterminate form “ $\frac{0}{0}$ ”. However, these limits are equal to 1, 0, and $-\infty$, respectively.

X54. Calculate the limit below.

$$\lim_{x \rightarrow -\infty} \left(\frac{2 - 3e^x + 4e^{-x}}{5 + 7e^x - 15e^{-x}} \right)$$

Solution

Recall that $\lim_{x \rightarrow -\infty} e^{-x} = \infty$ and $\lim_{x \rightarrow -\infty} e^x = 0$. Hence the “leading terms” of numerator and denominator are each “ e^{-x} ”. We factor out these leading terms, and then compute the limit.

$$\lim_{x \rightarrow -\infty} \left(\frac{e^{-x} (2e^x - 3e^{2x} + 4)}{e^{-x} (5e^x + 7e^{2x} - 15)} \right) = \lim_{x \rightarrow -\infty} \left(\frac{2e^x - 3e^{2x} + 4}{5e^x + 7e^{2x} - 15} \right) = \frac{0 - 0 + 4}{0 + 0 - 15} = -\frac{4}{15}$$

X55. Consider the function $f(x)$ below, where a and b are unspecified constants.

$$f(x) = \begin{cases} ax^2 - 7x + b & x < 2 \\ 10 & x = 2 \\ ae^{x-2} + b \ln(x-1) & x > 2 \end{cases}$$

Find the values of a and b for which f is continuous for all x , or determine that no such values exist. Write “NONE” in the answer boxes if no such values exist.

In your work, you must use proper notation and limit-based methods to solve this problem. Solutions that have work that does not have proper notation or which is not based on limits will not receive full credit.

Solution

Each piece of f is continuous on the corresponding interval. So we need only impose continuity on f at $x = 2$ to ensure f is continuous for all x . Thus we must have:

$$\lim_{x \rightarrow 2^-} f(x) = \lim_{x \rightarrow 2^+} f(x) = f(2)$$

We now calculate these quantities.

$$\begin{aligned} \lim_{x \rightarrow 2^-} f(x) &= \lim_{x \rightarrow 2^-} (ax^2 - 7x + b) = 4a - 14 + b \\ \lim_{x \rightarrow 2^+} f(x) &= \lim_{x \rightarrow 2^+} (ae^{x-2} + b \ln(x-1)) = ae^0 + b \ln(1) = a \\ f(2) &= 10 \end{aligned}$$

So we must have $4a - 14 + b = a = 10$. We immediately find that $a = 10$. Then the equation $4a - 14 + b = 10$ (with $a = 10$) gives us $b = -16$.

X56. Let $f(x) = \frac{x^3 - 7x^2 + 10x}{x^2 - 6x}$.

- Find the domain of f . Write your answer using interval notation.
- Find all values of x where f is discontinuous.
- For each value of x where f is discontinuous, classify the type of discontinuity as “removable”, “jump”, “infinite”, or “essential”. Clearly label your work and justify your answers.

Solution

- Since f is a rational function, its domain is all real numbers except where $x^2 - 6x = 0$, i.e., the set $(-\infty, 0) \cup (0, 6) \cup (6, \infty)$.
- Since f is a rational function, it is a continuous precisely on its domain. Hence f is discontinuous at both $x = 0$ and $x = 6$.
- We examine the limits of f at $x = 0$ and $x = 6$. For $x = 0$, we have:

$$\lim_{x \rightarrow 0} \left(\frac{x^3 - 7x^2 + 10x}{x^2 - 6x} \right) = \lim_{x \rightarrow 0} \left(\frac{x(x-2)(x-5)}{x(x-6)} \right) = \lim_{x \rightarrow 0} \left(\frac{(x-2)(x-5)}{x-6} \right) = -\frac{3}{5}$$

Since this limit is finite, we conclude that f has a removable discontinuity at $x = 0$.

For $x = 6$, we simply observe that direct substitution of $x = 6$ into f gives the expression “ $\frac{\text{nonzero}}{0}$ ”, which implies $x = 6$ is a vertical asymptote. Hence f has an infinite discontinuity at $x = 6$.

X57. Let $f(x) = \frac{x^2 - 3}{x - 1}$. Use the limit definition of derivative to calculate $f'(2)$.

Solution

We have the following:

$$\begin{aligned} f'(2) &= \lim_{x \rightarrow 2} \left(\frac{f(x) - f(2)}{x - 2} \right) = \lim_{x \rightarrow 2} \left(\frac{\frac{x^2 - 3}{x - 1} - 1}{x - 2} \right) = \lim_{x \rightarrow 2} \left(\frac{x^2 - 3 - (x - 1)}{(x - 1)(x - 2)} \right) \\ &= \lim_{x \rightarrow 2} \left(\frac{x^2 - x + 2}{(x - 1)(x - 2)} \right) = \lim_{x \rightarrow 2} \left(\frac{(x - 2)(x + 1)}{(x - 1)(x - 2)} \right) = \lim_{x \rightarrow 2} \left(\frac{x + 1}{x - 1} \right) = \frac{2 + 1}{2 - 1} = 3 \end{aligned}$$

X58. Use the limit definition of derivative to find an equation of the tangent line to $f(x) = 2x^2 + x + 5$ at $x = -1$.

Solution

The point of tangency is $(-1, f(-1)) = (-1, 6)$. The slope is given by the definition of derivative.

$$\begin{aligned} f'(-1) &= \lim_{x \rightarrow -1} \left(\frac{f(x) - f(-1)}{x + 1} \right) = \lim_{x \rightarrow -1} \left(\frac{2x^2 + x + 5 - 6}{x + 1} \right) \\ &= \lim_{x \rightarrow -1} \left(\frac{(2x - 1)(x + 1)}{x + 1} \right) = \lim_{x \rightarrow -1} (2x - 1) = -2 - 1 = -3 \end{aligned}$$

Thus an equation of the tangent line is $y = 6 - 3(x + 1)$.

X59. Find the x -coordinate of each point on the graph of $y = x^3e^{-5x}$ where the tangent line is horizontal.

Solution

First we find the derivative using product rule and chain rule.

$$f'(x) = 3x^2e^{-5x} + x^3e^{-5x} \cdot (-5) = x^2e^{-5x}(3 - 5x)$$

The tangent line is horizontal where the derivative is equal to 0.

$$x^2e^{-5x}(3 - 5x) = 0 \implies x = 0 \quad \text{or} \quad x = \frac{3}{5}$$

X60. Calculate each derivative below. Do not simplify your answer.

(a) $\frac{d}{dx} \left(\frac{x \sin(x)}{\pi^3 + \ln(x)} \right)$

(b) $\frac{d}{dx} \left((\sqrt{5x - 8} + x^2)^{1/3} \right)$

Solution

(a) Use quotient rule, then product rule.

$$\frac{d}{dx} \left(\frac{x \sin(x)}{\pi^3 + \ln(x)} \right) = \frac{(1 \cdot \sin(x) + x \cos(x)) (\pi^3 + \ln(x)) - x \sin(x) \cdot \frac{1}{x}}{(\pi^3 + \ln(x))^2}$$

(b) Use chain rule twice.

$$\frac{d}{dx} \left((\sqrt{5x - 8} + x^2)^{1/3} \right) = \frac{1}{3} (\sqrt{5x - 8} + x^2)^{-2/3} \cdot \left(\frac{1}{2} (5x - 8)^{-1/2} \cdot 5 + 2x \right)$$

X61. Suppose x and y are implicitly related by the following equation.

$$5 + xy^2 = \frac{y}{2 - x^3}$$

Find $\frac{dy}{dx}$ for a general point on the curve.

Solution

First multiply both sides of the equation by $2 - x^3$ and expand the left side.

$$10 - 5x^3 + 2xy^2 - x^4y^2 = y$$

Now differentiate with respect to x , using product rule twice on the left side.

$$-15x^2 + 2y^2 + 4xy \frac{dy}{dx} - 4x^3y^2 - 2x^4y \frac{dy}{dx} = \frac{dy}{dx}$$

Now solve algebraically for $\frac{dy}{dx}$.

$$\frac{dy}{dx} = \frac{15x^2 - 2y^2 + 4x^3y^2}{4xy - 2x^4y - 1}$$

X62. Suppose x and y are implicitly related by the following equation.

$$6x^2 - 3xy + 2y^2 = 52$$

Find all points (both x - and y -coordinates) on the curve where the tangent line is horizontal.

Solution

First differentiate both sides with respect to x .

$$12x - 3y - 3x \frac{dy}{dx} + 4y \frac{dy}{dx} = 0$$

At a point where the tangent line is horizontal, we have $\frac{dy}{dx} = 0$. So putting $\frac{dy}{dx} = 0$ in the above equation gives

$$12x - 3y = 0 \implies y = 4x$$

Thus the point must both satisfy the equation $y = 4x$ and lie on the curve. So we substitute $y = 4x$ into the original equation that describes the curve.

$$6x^2 - 3x(4x) + 2(4x)^2 = 52 \implies 26x^2 = 52 \implies x = -\sqrt{2} \quad \text{or} \quad x = \sqrt{2}$$

Thus there are two points where the tangent line is horizontal: $(-\sqrt{2}, -4\sqrt{2})$ and $(\sqrt{2}, 4\sqrt{2})$.

X63. The total surface area of a cube is changing at a rate of $8 \text{ in}^2/\text{s}$ when the length of one of the sides is 20 in. At what rate is the volume of the cube changing at that time? *You must include correct units as part of your answer.*

Solution

We have the following:

$$V = x^3 \quad A = 6x^2$$

where x is the side length of the cube, A is the total surface area, and V is the volume. Differentiating these equations with respect to t gives us:

$$\frac{dV}{dt} = 3x^2 \frac{dx}{dt} \quad \frac{dA}{dt} = 12x \frac{dx}{dt}$$

We are given $\frac{dA}{dt} = 8$ when $x = 20$. Substituting these values into the last two equations gives us:

$$\frac{dV}{dt} = 1200 \frac{dx}{dt} \quad 8 = 240 \frac{dx}{dt}$$

The second of these last equations gives $\frac{dx}{dt} = \frac{1}{30}$, whence the first equation gives the rate of change of the volume:

$$\frac{dV}{dt} = 1200 \cdot \frac{1}{30} = 40$$

The units are in^3/s .

- X64.** A 2-meter tall person is initially standing 4 meters from point P directly beneath a lantern hanging 14 meters above the ground, as shown in the figure below. The person then begins to walk towards point P at 1.5 m/sec. Let x denote the distance between the person's feet and the point P . Let y denote the length of the person's shadow.

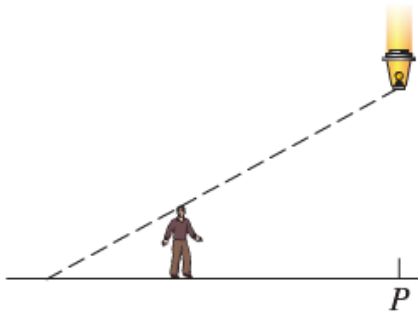

- Write an equation that relates x and y .
- Write an equation that expresses the English sentence “The person begins to walk towards point P at 1.5 m/sec.”
- At what rate is the length of the person's shadow changing when the person is 3 meters from point P ? You must include correct units as part of your answer.

Solution

- Use the principle of similar triangles. The smaller triangle has legs y (length of the shadow) and 2 (height of person). The larger triangle has legs $x + y$ (sum of length of shadow and distance from person to point P) and 14 (height of lantern). Thus we have:

$$\frac{x + y}{14} = \frac{y}{2}$$

Rearranging this equation gives the simpler relation $x = 6y$.

- $\frac{dx}{dt} = -1.5$
- We seek the value of $\frac{dy}{dt}$ at the desired time. Differentiating the equation $x = 6y$ with respect to y gives $\frac{dx}{dt} = 6\frac{dy}{dt}$. Putting $\frac{dx}{dt} = -1.5$ gives $-1.5 = 6\frac{dy}{dt}$, or $\frac{dy}{dt} = -0.25$. The units are m/sec.

- X65.** Find the absolute extrema of $f(x) = 10 + 8x^2 - x^4$ on the interval $[-1, 3]$.

Solution

Since f is differentiable on its domain, the absolute extrema occur either where $f'(x) = 0$ or at the endpoints of the interval $[-1, 3]$. We have:

$$f'(x) = 16x - 4x^3 = 4x(4 - x^2) = 4x(2 - x)(2 + x) = 0$$

Solutions to $f'(x) = 0$ are $x = 0$ and $x = 2$. (We ignore the solution $x = -2$ since it lies outside the interval $[-1, 3]$.) Now we compare the critical values and the endpoint values: $f(-1) = 17$, $f(0) = 10$, $f(2) = 26$, and $f(3) = 1$. Hence the absolute minimum value is 1 and the absolute maximum value is 26.

- X66.** Let $f(x) = x^2(5x + 9)^{1/5}$. Observe that the domain of f is $(-\infty, \infty)$. Calculate the critical numbers of f . For each critical number you find, explain precisely why your answer is a critical number.

Solution

We first calculate $f'(x)$.

$$f'(x) = 2x(5x + 9)^{1/5} + x^2 \cdot \frac{1}{5}(5x + 9)^{-4/5} \cdot 5 = (5x + 9)^{-4/5} (2x(5x + 9) + x^2) = \frac{x(11x + 18)}{(5x + 9)^{4/5}}$$

The critical numbers of f are where $f'(x) = 0$ (or $x = 0$ and $x = -\frac{18}{11}$) or where $f'(x)$ does not exist (or $x = -\frac{9}{5}$).

- X67.** Consider the function f and its derivatives below.

$$f(x) = x^2 - \frac{27}{x} \quad f'(x) = 2x + \frac{27}{x^2} \quad f''(x) = 2 - \frac{54}{x^3}$$

Fill in the table below with information about the graph of $y = f(x)$. For each part, write “NONE” as your answer if appropriate. (You may use the bottom or back of this page for scratch work.) **You do not have to show work, and each part of the table will be graded with no partial credit.**

- X68.** Calculate the limit or show that it does not exist. If the limit is infinite, write “ $+\infty$ ” or “ $-\infty$ ” as your answer, instead of “does not exist”, as appropriate.

$$\lim_{x \rightarrow 0} \left(\frac{xe^{-2x} + \cos(x) - 1 - x}{x^2} \right)$$

Solution

Direct substitution of $x = 0$ gives the indeterminate form “ $\frac{0}{0}$ ”. So we use L’Hospital’s Rule (and again each time we encounter the same indeterminate form).

$$\begin{aligned} \lim_{x \rightarrow 0} \left(\frac{xe^{-2x} + \cos(x) - 1 - x}{x^2} \right) &\stackrel{H}{=} \lim_{x \rightarrow 0} \left(\frac{e^{-2x} - 2xe^{-2x} - \sin(x) - 1}{2x} \right) \\ &\stackrel{H}{=} \lim_{x \rightarrow 0} \left(\frac{-2e^{-2x} - 2e^{-2x} + 4xe^{-2x} - \cos(x)}{2} \right) = \frac{-2 - 2 + 0 - 1}{2} = -\frac{5}{2} \end{aligned}$$

- X69.** An airline policy states that all carry-on baggage must be box-shaped with a sum of length, width, and height not exceeding 60 in. Suppose the length of a particular carry-on is three times its width. Under the airline’s policy, what are the dimensions of such a carry-on with the greatest volume?

You must use calculus-based methods to solve this problem, and you must demonstrate that your answer really does give the greatest volume.

Solution

Let L , W , and H be the length, width, and height of the box, respectively. Our goal is to find the dimensions that maximize the value of the objective function $V(L, W, H) = LWH$.

The airline policy gives the constraint $L + W + H = 60$ and the shape of the carry-on gives the constraint $L = 3W$. Hence we also have $3W + W + H = 60$, or $H = 60 - 4W$. Thus our objective function in terms of the one variable W is:

$$f(W) = (3W) \cdot W \cdot (60 - 4W) = 180W^2 - 12W^3$$

The length W must be non-negative, but so must the height, whence $W \geq 0$ and $60 - 4W \geq 0$. So we have $0 \leq W \leq 15$. Thus the interval of interest is $[0, 15]$.

To find the maximum of $f(W)$ on $[0, 15]$, we solve $f'(W) = 0$.

$$f'(W) = 360W - 36W^2 = 36W(10 - W) = 0 \implies W = 0 \quad \text{or} \quad W = 10$$

We now check the critical values and the endpoint values: $f(0) = f(15) = 0$ and $f(10) = 6000$. Hence the absolute maximum value of $f(W)$ occurs when $W = 10$. The other dimensions of the box are $L = 3W = 30$ and $H = 60 - 4W = 20$.

X70. Use linear approximation to estimate the number $\frac{1}{(2.9)^2}$. Do not simplify your answer.

Solution

Let $f(x) = x^{-2}$ and consider the tangent line to $y = f(x)$ at $x = 3$. We have $f'(x) = -2x^{-3}$, and thus $f'(3) = -\frac{2}{27}$. Thus the tangent line has the following equation:

$$y = \frac{1}{9} - \frac{2}{27}(x - 3)$$

Thus if x is near 3, we have

$$\frac{1}{x^2} \approx \frac{1}{9} - \frac{2}{27}(x - 3)$$

Putting $x = 2.9$ gives the approximation

$$\frac{1}{(2.9)^2} \approx \frac{1}{9} - \frac{2}{27}(-0.1) = \frac{28}{270}$$

X71. The position of a particle at time t is given by $x(t) = 5 + 20t^{3/5} + t$. Use linear approximation to estimate the change in the particle's position between $t = 32$ and $t = 35$. Do not simplify your answer.

Solution

We consider the tangent line to $x(t)$ at $t = 32$. We have $x'(t) = 12t^{-2/5} + 1$, and thus $x'(32) = 3 + 1 = 4$. Thus the tangent line has the following equation:

$$y - x(32) = 4(t - 32)$$

Thus if t is near 32, we have

$$x(t) - x(32) \approx 4(t - 32)$$

Putting $t = 35$ gives the desired difference in position.

$$\Delta x = x(35) - x(32) \approx 4(35 - 32) = 12$$

X72. If x units of a certain product are being produced, the marginal cost is

$$\frac{dC}{dx} = 5 + 12x + 20x^{3/2}$$

Suppose the total cost of producing 1 unit is 100 (measured in thousands of dollars). Calculate the total cost of producing 4 units.

Solution

We compute the antiderivative to obtain the total cost.

$$C(x) = \int (5 + 12x + 20x^{3/2}) dx = 5x + 6x^2 + 8x^{5/2} + K$$

where K is some constant. We are given the condition $C(1) = 100$, whence $19 + K = 100$, or $K = 81$. The total cost function is thus:

$$C(x) = 5x + 6x^2 + 8x^{5/2} + 81$$

So the total cost of producing 4 units is

$$C(4) = 20 + 24 + 8 \cdot 32 + 81 = 381$$

X73. Calculate each of the following. You do not have to simplify your answers.

(a) $\int \left(\frac{3t^2 - \sqrt{t} + 4}{5t} \right) dt$

(b) $\int_{-1}^3 (3x^2 + 2e^x) dx$

Solution

(a) Divide each term and then antidifferentiate.

$$\int \left(\frac{3t^2 - \sqrt{t} + 4}{5t} \right) dt = \int \left(\frac{3}{5}t - \frac{1}{5}t^{-1/2} + \frac{4}{5}t^{-1} \right) dt = \frac{3}{10}t^2 - \frac{2}{5}t^{1/2} + \frac{4}{5} \ln(|t|) + C$$

(b) Find the antiderivative, then use the fundamental theorem of calculus.

$$\int_{-1}^3 (3x^2 + 2e^x) dx = (x^3 + 2e^x) \Big|_{-1}^3 = (27 + 2e^3) - (-1 + 2e^{-1}) = 28 + 2e^3 - 2e^{-1}$$

3.4 Fall 2022

X74. Find all solutions to the given equation.

$$\log_2(x - 3) + 2 = \log_2(x + 9)$$

Solution

Combine the logarithms. Then exponentiate.

$$\log_2(x - 3) + 2 = \log_2(x + 9)$$

$$2 = \log_2(x + 9) - \log_2(x - 3)$$

$$2 = \log_2\left(\frac{x + 9}{x - 3}\right)$$

$$4 = \frac{x + 9}{x - 3}$$

$$4x - 12 = x + 9$$

$$x = 7$$

X75. Fully simplify the given expression. Assume any common factors are non-zero.

$$\frac{100}{x^2 - 25} - \frac{2x}{x + 5}$$

Solution

Find a common denominator.

$$\begin{aligned} \frac{100}{x^2 - 25} - \frac{2x}{x + 5} &= \frac{100}{(x - 5)(x + 5)} - \frac{2x}{x + 5} \cdot \frac{x - 5}{x - 5} = \frac{100 - 2x(x - 5)}{(x - 5)(x + 5)} \\ &= \frac{100 - 2x^2 + 10x}{(x - 5)(x + 5)} = \frac{-2(x - 10)(x + 5)}{(x - 5)(x + 5)} = \frac{-2(x - 10)}{x - 5} \end{aligned}$$

X76. For each part, calculate the limit or determine it does not exist. You must show all work, and your work will be graded on its correctness and coherence.

(a) $\lim_{x \rightarrow 6} \left(\frac{x^2 - 36}{2x^2 - 11x - 6} \right)$

(b) $\lim_{x \rightarrow 2} \left(\frac{\frac{3x+1}{x-1} - 7}{x - 2} \right)$

Solution

(a) Cancel common factors.

$$\lim_{x \rightarrow 6} \left(\frac{x^2 - 36}{2x^2 - 11x - 6} \right) = \lim_{x \rightarrow 6} \left(\frac{(x - 6)(x + 6)}{(2x + 1)(x - 6)} \right) = \lim_{x \rightarrow 6} \left(\frac{x + 6}{2x + 1} \right) = \frac{12}{13}$$

(b) Clear the denominators and cancel common factors.

$$\begin{aligned} \lim_{x \rightarrow 2} \left(\frac{\frac{3x+1}{x-1} - 7}{x-2} \right) &= \lim_{x \rightarrow 2} \left(\frac{3x+1-7(x-1)}{(x-2)(x-1)} \right) \\ &= \lim_{x \rightarrow 2} \left(\frac{-4x+8}{(x-2)(x-1)} \right) = \lim_{x \rightarrow 2} \left(\frac{-4(x-2)}{(x-2)(x-1)} \right) = \lim_{x \rightarrow 2} \left(\frac{-4}{x-1} \right) = -4 \end{aligned}$$

X77. On the axes below, sketch the graph of a function $f(x)$ that satisfies the following properties:

- the domain of $f(x)$ is $[-7, 4) \cup (4, 7]$
- $\lim_{x \rightarrow -5} f(x) \neq f(-5)$
- $\lim_{x \rightarrow -3^-} f(x) = f(-3)$ but $\lim_{x \rightarrow -3} f(x)$ does not exist
- $\lim_{x \rightarrow 2} f(x) = f(2) = 4$
- $\lim_{x \rightarrow 4^+} f(x) = 2$ but $\lim_{x \rightarrow 4} f(x)$ does not exist

Solution

There are many such solutions. Here is one.

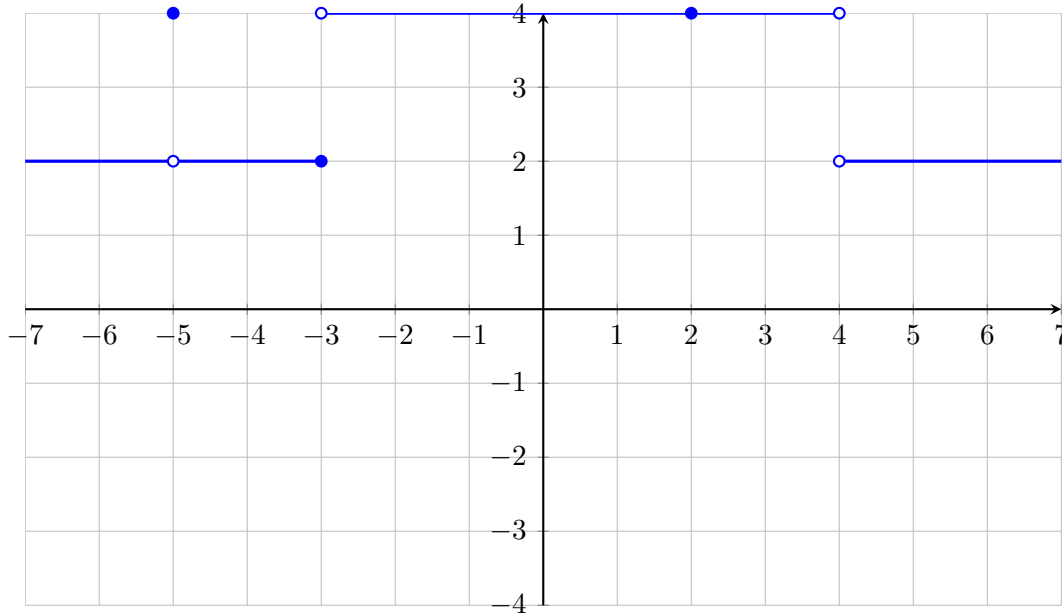

X78. Use rationalization to simplify the expression below. All common factors must be canceled.

$$\frac{3 - \sqrt{2-x}}{x+7}$$

Solution

Rationalize the numerator and cancel common factors.

$$\frac{3 - \sqrt{2-x}}{x+7} \cdot \frac{3 + \sqrt{2-x}}{3 + \sqrt{2-x}} = \frac{9 - (2-x)}{(x+7)(3 + \sqrt{2-x})} = \frac{x+7}{(x+7)(3 + \sqrt{2-x})} = \frac{1}{3 + \sqrt{2-x}}$$

X79. Find all vertical asymptotes of $f(x)$. You must justify your answers precisely.

$$f(x) = \frac{\sin(2x)}{x^2 - 10x}$$

Solution

We put the denominator to 0.

$$x^2 - 10x = x(x - 10) = 0 \implies x = 0 \text{ or } x = 10$$

Thus $x = 0$ and $x = 10$ are our candidate VA's. For $x = 10$, we note that direct substitution into f gives " $\frac{\sin(20)}{0}$ " (i.e., a nonzero number divided by 0). Thus $x = 10$ is a VA of f . However, for $x = 0$ we have:

$$\lim_{x \rightarrow 0} f(x) = \lim_{x \rightarrow 0} \left(\frac{\sin(2x)}{2x} \cdot \frac{2}{x-10} \right) = 1 \cdot \frac{2}{0-10} = -\frac{1}{5}$$

We have used the special limit $\lim_{\theta \rightarrow 0} \left(\frac{\sin(a\theta)}{a\theta} \right) = 1$. Thus $x = 0$ is not a VA of f .

X80. Find all horizontal asymptotes of $g(x)$. You must justify your answers precisely.

$$g(x) = \frac{3e^{-2x} + 4e^{5x} - 10}{6e^{-9x} - 7e^{8x} + 1}$$

Solution

We must compute the limits at infinity. For $x \rightarrow -\infty$, the dominant term in the denominator is e^{-9x} . So we divide all terms by e^{-9x} (equivalently, multiply all terms by e^{9x}) to obtain the following:

$$\lim_{x \rightarrow -\infty} g(x) = \lim_{x \rightarrow -\infty} \left(\frac{e^{9x}}{e^{9x}} \cdot \frac{3e^{-2x} + 4e^{5x} - 10}{6e^{-9x} - 7e^{8x} + 1} \right) = \lim_{x \rightarrow -\infty} \left(\frac{3e^{7x} + 4e^{14x} - 10e^{9x}}{6 - 7e^{17x} + e^{9x}} \right) = \frac{0 + 0 - 0}{6 - 0 + 0} = 0$$

For $x \rightarrow \infty$, the dominant term in the denominator is e^{8x} . So we divide all terms by e^{8x} (equivalently, multiply all terms by e^{-8x}) to obtain the following:

$$\lim_{x \rightarrow \infty} g(x) = \lim_{x \rightarrow \infty} \left(\frac{e^{-8x}}{e^{-8x}} \cdot \frac{3e^{-2x} + 4e^{5x} - 10}{6e^{-9x} - 7e^{8x} + 1} \right) = \lim_{x \rightarrow \infty} \left(\frac{3e^{-10x} + 4e^{-3x} - 10e^{-8x}}{6e^{-17x} - 7 + e^{-8x}} \right) = \frac{0 + 0 - 0}{0 - 7 + 0} = 0$$

Thus the only HA of g is $y = 0$.

X81. Find the value of A that makes $f(x)$ continuous for all x , or determine that no such value exists. Write "DNE" if no such value of A exists. Your solution must be based on limits to receive full credit.

$$f(x) = \begin{cases} \frac{\sin(Ax)}{x} - 2 & x < 0 \\ 9 & x = 0 \\ 3x^3 - A \cos(x) + 10 & x > 0 \end{cases}$$

Solution

We must have that the left-limit, right-limit, and function value at $x = 0$ are all equal. First we compute each of these.

$$\begin{aligned}\lim_{x \rightarrow 0^-} f(x) &= \lim_{x \rightarrow 0^-} \left(\frac{\sin(Ax)}{x} - 2 \right) = \lim_{x \rightarrow 0^-} \left(\frac{\sin(Ax)}{Ax} \cdot A - 2 \right) = 1 \cdot A - 2 = A - 2 \\ \lim_{x \rightarrow 0^+} f(x) &= \lim_{x \rightarrow 0^+} (3x^3 - A \cos(x) + 10) = 0 - A + 10 = 10 - A \\ f(0) &= 9\end{aligned}$$

Hence we must have $A - 2 = 10 - A = 9$. However, this is impossible as the equation $A - 2 = 9$ implies $A = 11$ and the equation $10 - A = 9$ implies $A = 1$. Hence there is no value of A for which f is continuous.

- X82.** Calculate $\lim_{x \rightarrow -3} \left(\frac{\sqrt{2x+15}-3}{x^2+8x+15} \right)$ or determine that it does not exist. If the limit is infinite, write “ $+\infty$ ” or “ $-\infty$ ” as your answer, as appropriate, instead of “DNE”.

Solution

Rationalize the numerator and cancel common factors.

$$\begin{aligned}\lim_{x \rightarrow -3} \left(\frac{\sqrt{2x+15}-3}{x^2+8x+15} \cdot \frac{\sqrt{2x+15}+3}{\sqrt{2x+15}+3} \right) &= \lim_{x \rightarrow -3} \left(\frac{2x+15-9}{(x+5)(x+3)(\sqrt{2x+15}+3)} \right) \\ &= \lim_{x \rightarrow -3} \left(\frac{2(x+3)}{(x+5)(x+3)(\sqrt{2x+15}+3)} \right) = \lim_{x \rightarrow -3} \left(\frac{2}{(x+5)(\sqrt{2x+15}+3)} \right) = \frac{2}{2 \cdot (3+3)} = \frac{1}{6}\end{aligned}$$

- X83.** The limit below is equal to the derivative of some function $f(x)$ at some point $x = a$. Identify both the function f and the value of a . No work is required.

$$f'(a) = \lim_{h \rightarrow 0} \left(\frac{\frac{1}{(3+h)^2+1} - \frac{1}{10}}{h} \right)$$

Solution

Compare the given limit to the definition of the derivative.

$$f'(a) = \lim_{h \rightarrow 0} \left(\frac{f(a+h) - f(a)}{h} \right)$$

Put $f(x) = \frac{1}{x^2+1}$ and $a = 3$. Then the given limit is equal to $f'(3)$.

- X84.** Let $f(x) = 2x^2 - 6x + 10$.

- Use the limit definition of derivative to calculate $f'(-1)$.
- Find the tangent line to $y = f(x)$ at $x = -1$.

Solution

(a) Observe that $f(-1) = 18$. So then we have the following.

$$\begin{aligned} f'(-1) &= \lim_{x \rightarrow -1} \left(\frac{f(x) - f(-1)}{x + 1} \right) = \lim_{x \rightarrow -1} \left(\frac{2x^2 - 6x + 10 - 18}{x + 1} \right) \\ &= \lim_{x \rightarrow -1} \left(\frac{2(x - 4)(x + 1)}{x + 1} \right) = \lim_{x \rightarrow -1} (2(x - 4)) = -10 \end{aligned}$$

(b) The point of tangency is $(-1, 18)$ and the slope of the tangent line is $f'(-1) = -10$. Hence an equation of the tangent line $y = 18 - 10(x + 1)$.

X85. For each part, calculate the derivative. You do not have to show work and there is no partial credit.

(a) $\frac{d}{dx} \left(\cos(x) - \frac{5}{x^7} \right)$

(b) $\frac{d}{dx} (8 \sin(x) \ln(x))$

(c) $\frac{d}{dx} \left(\frac{2x^4}{10 - 3x} \right)$

Solution

(a) Use power rule on the second term.

$$\frac{d}{dx} (\cos(x) - 5x^{-7}) = -\sin(x) + 35x^{-8}$$

(b) Use product rule.

$$\frac{d}{dx} (8 \sin(x) \ln(x)) = 8 \cos(x) \ln(x) + 8 \sin(x) \cdot \frac{1}{x}$$

(c) Use quotient rule.

$$\frac{d}{dx} \left(\frac{2x^4}{10 - 3x} \right) = \frac{8x^3(10 - 3x) - 2x^4(-3)}{(10 - 3x)^3}$$

X86. For each part, calculate the derivative. Do not simplify your answer.

(a) $\frac{d}{dx} \left(\sqrt[5]{4 \sin(x) + e^{3x-7}} \right)$

(b) $\frac{d}{dx} \left(\frac{2x^4 \tan(x)}{3x + 10} \right)$

Solution

(a) Use chain rule twice.

$$\frac{d}{dx} \left(\sqrt[5]{4 \sin(x) + e^{3x-7}} \right) = \frac{1}{5} (4 \sin(x) + e^{3x-7})^{-4/5} \cdot (4 \cos(x) + 3e^{3x-7})$$

(b) Use quotient rule, then product rule.

$$\frac{d}{dx} \left(\frac{2x^4 \tan(x)}{3x + 10} \right) = \frac{(8x^3 \tan(x) + 2x^4 \sec^2(x)) \cdot (3x + 10) - 2x^4 \tan(x) \cdot 3}{(3x + 10)^2}$$

X87. Find the x -coordinate of each point on the graph of $y = 3x^2 + \frac{60}{x}$ where the tangent line is horizontal.

Solution

First write $f(x) = 3x^2 + 60x^{-1}$ and use the power rule.

$$f'(x) = 6x - 60x^{-2}$$

Now we solve the equation $f'(x) = 0$.

$$6x - \frac{60}{x^2} = 0$$

$$6x^3 - 60 = 0$$

$$x^3 = 10 \implies x = 10^{1/3}$$

Thus the graph $y = f(x)$ has a horizontal tangent at $x = 10^{1/3}$ only.

X88. Find the x -coordinate of each point on the graph $y = (x^2 + x - 1)e^{3x}$ where the tangent line is horizontal.

Solution

First use product rule (and chain rule) to find $\frac{dy}{dx}$.

$$\frac{dy}{dx} = (2x + 1)e^{3x} + (x^2 + x - 1)e^{3x} \cdot 3 = (3x^2 + 5x - 2)e^{3x} = (3x - 1)(x + 2)e^{3x}$$

The graph has horizontal tangent lines where $\frac{dy}{dx} = 0$, that is, at $x = \frac{1}{3}$ and $x = -2$.

X89. Find $\frac{dy}{dx}$ for a general point on the following curve.

$$x \sin(y) + 10 = \ln(y^2 + x)$$

Solution

Differentiate each side of the equation with respect to x . Use product rule on the left side and chain rule twice on the right side.

$$1 \cdot \sin(y) + x \cos(y) \frac{dy}{dx} = \frac{1}{y^2 + x} \cdot \left(2y \frac{dy}{dx} + 1 \right)$$

Now we algebraically solve for $\frac{dy}{dx}$. Multiply both sides by $y^2 + x$, then solve for $\frac{dy}{dx}$.

$$\begin{aligned}(y^2 + x) \sin(y) + x(y^2 + x) \cos(y) \frac{dy}{dx} &= 2y \frac{dy}{dx} + 1 \\ (x(y^2 + x) \cos(y) - 2y) \frac{dy}{dx} &= 1 - (y^2 + x) \sin(y) \\ \frac{dy}{dx} &= \frac{1 - (y^2 + x) \sin(y)}{x(y^2 + x) \cos(y) - 2y}\end{aligned}$$

X90. Find the slope of the line tangent to the given curve at the point $(1, \frac{1}{4})$.

$$x \tan(\pi y) = 16y^2 + 3 \ln(x)$$

Solution

Differentiate each side of the equation with respect to x .

$$1 \tan(\pi y) + x \sec^2(\pi y) \cdot \pi \frac{dy}{dx} = 32y \frac{dy}{dx} + \frac{3}{x}$$

Now substitute the point, i.e., $x = 1$ and $y = \frac{1}{4}$. Recall that $\tan(\frac{\pi}{4}) = 1$ and $\sec(\frac{\pi}{4}) = \sqrt{2}$. Hence we obtain:

$$1 + 2\pi \frac{dy}{dx} = 8 \frac{dy}{dx} + 3$$

Solving for $\frac{dy}{dx}$ gives the slope of the tangent line:

$$\frac{dy}{dx} = \frac{2}{2\pi - 8} = \frac{1}{\pi - 4}$$

X91. A pebble is dropped into a lake and an expanding circular ripple results. When the radius of the ripple is 8 inches, the area enclosed by the ripple is changing at a rate of 48π in²/sec. What is the rate at which the radius is changing at this time? *You must include correct units as part of your answer.*

Solution

Let r and A be the radius and area enclosed by the circular ripple, respectively. We seek the value of $\frac{dr}{dt}$ at the time when $r = 8$ and $\frac{dA}{dt} = 48\pi$. We have that $A = \pi r^2$, and differentiating with respect to t gives:

$$\frac{dA}{dt} = 2\pi r \frac{dr}{dt}$$

Substituting $r = 8$ and $\frac{dA}{dt} = 48\pi$ gives $48\pi = 16\pi \frac{dr}{dt}$. Hence $\frac{dr}{dt} = 3$ in/sec.

X92. Let $f(x) = 3x^{4/3} - 300x^{1/3}$. Find all critical points of f . You must make clear why each of your answers is a critical point.

Solution

First we find $f'(x)$ using the power rule.

$$f'(x) = 4x^{1/3} - 100x^{-2/3} = \frac{4(x - 25)}{x^{2/3}}$$

The domain of $f(x)$ is $(-\infty, \infty)$. Hence critical points of f are solutions to the equation $f'(x) = 0$ (i.e., $x = 25$ only) or where $f'(x)$ does not exist (i.e., $x = 0$ only).

- X93.** Find the absolute extrema of $f(x) = \sqrt{2}\sin(x) + \cos^2(x)$ on the interval $[0, \pi]$. *Hint:* You will need the approximation $\sqrt{2} \approx 1.4$.

Solution

Since $f(x)$ is differentiable everywhere, the critical points of $f(x)$ are the solutions to $f'(x) = 0$.

$$f'(x) = \sqrt{2}\cos(x) + 2\cos(x) \cdot (-\sin(x)) = \cos(x) (\sqrt{2} - 2\sin(x))$$

The solutions in the interval $[0, \pi]$ to the equation $f'(x) = 0$ are a solution to $\cos(x) = 0$ (i.e., $x = \frac{\pi}{2}$ only) or a solution to $\sin(x) = \frac{\sqrt{2}}{2}$ (i.e., $x = \frac{\pi}{4}$ and $x = \frac{3\pi}{4}$ only).

Now we compare the critical values and the endpoint values.

$$\begin{aligned} f(0) &= 0 + 1^2 = 1 \\ f\left(\frac{\pi}{4}\right) &= \sqrt{2} \cdot \frac{1}{\sqrt{2}} + \left(\frac{1}{\sqrt{2}}\right)^2 = 1 + \frac{1}{2} = 1.5 \\ f\left(\frac{\pi}{2}\right) &= \sqrt{2} \cdot 1 + 0 = \sqrt{2} \approx 1.4 \\ f\left(\frac{3\pi}{4}\right) &= \sqrt{2} \cdot \frac{1}{\sqrt{2}} + \left(\frac{-1}{\sqrt{2}}\right)^2 = 1 + \frac{1}{2} = 1.5 \\ f(\pi) &= 0 + (-1)^2 = 1 \end{aligned}$$

So the absolute minimum value of $f(x)$ on the $[0, \pi]$ is 1 and the absolute maximum value is 1.5.

- X94.** Compute $\lim_{x \rightarrow 0} \left(\frac{e^{-5x} - 1}{\ln(1 + 13x)} \right)$. If the limit is infinite, write “ $+\infty$ ” or “ $-\infty$ ” instead of “DNE”.

Solution

Direct substitution of $x = 0$ gives the indeterminate form “ $\frac{0}{0}$ ”, whence we can use l’Hospital’s Rule.

$$\lim_{x \rightarrow 0} \left(\frac{e^{-5x} - 1}{\ln(1 + 13x)} \right) \stackrel{H}{=} \lim_{x \rightarrow 0} \left(\frac{-5e^{-5x}}{\frac{1}{1+13x} \cdot 13} \right) = \frac{-5 \cdot 1}{\frac{1}{1+0} \cdot 13} = -\frac{5}{13}$$

- X95.** Consider the function f and its derivatives below.

$$f(x) = \frac{x^4}{3-x} \quad f'(x) = \frac{x^3(12-3x)}{(3-x)^2} \quad f''(x) = \frac{6x^2((x-4)^2+2)}{(3-x)^3}$$

Fill in the table below with information about the graph of $y = f(x)$. Write your answers using interval notation if appropriate. For each part, write “NONE” as your answer if appropriate.

Solution

vertical asymptote(s) of f	$x = 3$
horizontal asymptote(s) of f	NONE
where f is decreasing	$(-\infty, 0], [4, \infty)$
where f is increasing	$[0, 3), (3, 4]$
x -coordinate(s) of local minima of f	$x = 0$
x -coordinate(s) of local maxima of f	$x = 4$
where f is concave down	$(-\infty, 3)$
where f is concave up	$(3, \infty)$
x -coordinate(s) of inflection point(s) of f	NONE

X96. Calculate the limit below or determine it does not exist.

X97. A rectangle is constructed with its lower two vertices on the x -axis and its upper two vertices on the parabola $y = 75 - 3x^2$. Find the dimensions of the rectangle with the greatest area.

In your work, you must clearly define your variables, identify any constraint equations, and identify your objective function (in terms of one variable). You must also verify that your answer really does give a maximum.

X98. Use linear approximation to estimate the value below. Do not simplify your answer.

X99. The total number of rabbits in a certain region t weeks after observations have begun is modeled by the equation $N(t) = 200 + 36t^{2/3}$. Use a linear approximation to estimate the increase in the rabbit population between $t = 64$ and $t = 67$.

X100. When x units of a product are produced, the derivative of the total cost C (measured in \$) is:

$$\frac{dC}{dx} = 3x^2 + 40x + 100$$

Suppose the total cost of producing 1 unit is \$150. Find the total cost of producing the first 2 units.

X101. Let $f(x) = 12 - 3x$. Calculate each of the following integrals using geometry. If you use the Fundamental Theorem of Calculus, you will receive no credit.

(a) $\int_0^5 f(x) dx$

(b) $\int_0^5 |f(x)| dx$

X102. Find the area of the region bounded by the graph of $y = (x^4 + 1)^2$, the x -axis, and the lines $x = 0$ and $x = 1$.

X103. Calculate each of the following integrals using any valid method taught in this course. You may need to use basic geometry, the Fundamental Theorem of Calculus, substitution rule, or some combination.

(a) $\int_{-5}^0 \sqrt{25 - x^2} dx$

(b) $\int_0^1 6x^2(x^3 + 26)^{1/2} dx$

(c) $\int_{-\ln(5)}^{\ln(6)} (2e^x + 3) dx$

4 Final Exams

4.1 Spring 2020

3 p

Z1. Find all values of a in $(-4, 4)$ such that $\lim_{x \rightarrow a} f(x)$ does not exist, where the graph of $y = f(x)$ is given below.

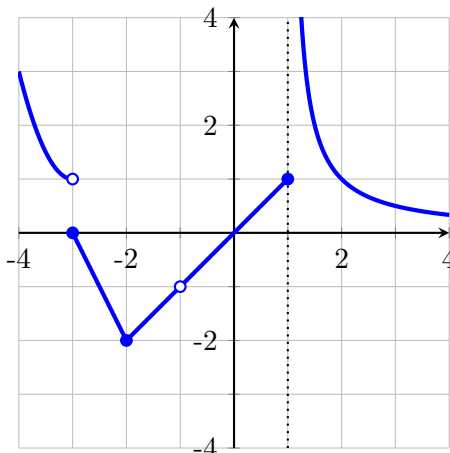
**Solution**

$a = -3$ and $a = 1$ only.

3 p

Z2. Which statement is true about the graph of $f(x) = |x| + 91$ at the point $(0, 91)$?

- (a) The graph has a tangent line at $y = 91$.
- (b) The graph has infinitely many tangent lines.
- (c) The graph has no tangent line.
- (d) The graph has two tangent lines: $y = x + 91$ and $y = -x + 91$.
- (e) None of the above statements is true.

Solution

Choice C. Since $f(x)$ is not differentiable at $x = 0$, $f'(0)$ doesn't exist. So there is no tangent line at $x = 0$.

3 p

Z3. Suppose the cost (in dollars) of manufacturing q units is given by

$$C(q) = 6q^2 + 34q + 112$$

Use marginal analysis to estimate the cost of producing the 5th unit.

Solution

The exact cost of the 5th unit is $\Delta C = C(5) - C(4)$, which is approximately $C'(4)$ by linear approximation. Hence

$$\Delta C \approx C'(4) = (12q + 34)|_{q=4} = 82$$

3 p

- Z4.** Consider the function $f(x)$, where k is an unspecified constant. Find the value of k for which f is continuous for all x , or show that no such value of k exists.

$$f(x) = \begin{cases} 38 + kx & x < 3 \\ kx^2 + x - k & x \geq 3 \end{cases}$$

In your work, you must use limit-based methods to solve this problem. Solutions that have work that is not based on limits will not receive full credit.

Solution

First we calculate the left-limit, right-limit, and function value at $x = 3$.

$$\begin{aligned} \lim_{x \rightarrow 3^-} f(x) &= \lim_{x \rightarrow 3^-} (38 + kx) = 38 + 3k \\ \lim_{x \rightarrow 3^+} f(x) &= \lim_{x \rightarrow 3^+} (kx^2 + x - k) = 8k + 3 \\ f(3) &= 8k + 3 \end{aligned}$$

To make f continuous at $x = 3$, the left-limit, right-limit, and function value at $x = 3$ must all be equal. Hence we must have

$$38 + 3k = 8k + 3$$

Hence $k = 7$.

3 p

- Z5.** The figure below shows the area of regions bounded by the graph of $y = f(x)$ and the x -axis, where $a = 4$, $b = 6$, and $c = 15$. Evaluate $\int_a^c (11f(x) - 6) dx$.

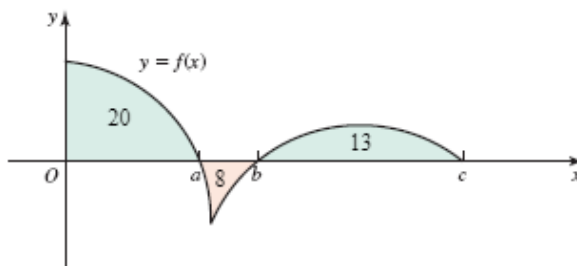

Solution

Split up the integral using linearity properties.

$$\int_a^c (11f(x) - 6) dx = 11 \int_a^c f(x) dx - 6 \int_a^c 1 dx = 11 \cdot (13 - 8) - 6 \cdot (15 - 4) = -11$$

13 p

- Z6.** Consider the function f and its first two derivatives below.

$$f(x) = \frac{99e^x}{(x-25)^{47}} + 98, \quad f'(x) = \frac{99e^x(x-72)}{(x-25)^{48}}, \quad f''(x) = \frac{99e^x((x-72)^2 + 47)}{(x-25)^{49}}$$

Fill in the table below with information about the graph of $y = f(x)$. For each part, write "NONE" as your answer if appropriate. Where applicable, give a comma-separated list of intervals that are as inclusive as possible.

You do not have to show work, and each table item will be graded with no partial credit.

Solution

equation(s) of vertical asymptote(s) of f	$y = 98$
equation(s) of horizontal asymptote(s) of f	$x = 25$
where f is decreasing	$(-\infty, 25), (25, 72]$
where f is increasing	$[72, \infty)$
x -coordinate(s) of local minima of f	$x = 72$
x -coordinate(s) of local maxima of f	NONE
where f is concave down	$(-\infty, 25)$
where f is concave up	$(25, \infty)$
x -coordinate(s) of inflection point(s) of f	NONE

6 p

Z7. A student is asked to calculate the following limit using l'Hospital's Rule and to show all their work.

$$L = \lim_{x \rightarrow 0} \left(\frac{\sin(2x) + 17x^2 + 2x}{4x^2 + \tan(x)} \right)$$

The student decides to cheat, so they find the solution online (shown below) and they submit the work as their own!

$$L = \lim_{x \rightarrow 0} \left(\frac{\sin(2x) + 17x^2 + 2x}{4x^2 + \tan(x)} \right) \quad (1)$$

$$= \lim_{x \rightarrow 0} \left(\frac{2 \cos(2x) + 34x + 2}{8x + \sec(x)^2} \right) \quad (2)$$

$$= \lim_{x \rightarrow 0} \left(\frac{-4 \sin(2x) + 34}{8 + 2 \sec(x)^2 \tan(x)} \right) \quad (3)$$

$$= \frac{-4 \sin(0) + 34}{8 + 2 \sec(0)^2 \tan(0)} \quad (4)$$

$$= \frac{0 + 34}{8 + 0} \quad (5)$$

$$= \frac{17}{4} \quad (6)$$

Unfortunately, this solution contains an error, and so the student lost all credit for the problem. The student was also later determined to be responsible for cheating, and so they earned a grade of 0 on the entire exam!

Your task is to find and correct the error(s). Answer the following questions.

- There may be several errors in this solution. Which line is the first incorrect line?
- Explain the error in the first incorrect line in your own words.
- Calculate the correct value of L (the original limit).

Solution

- (a) The first incorrect line is line (3).
- (b) In the transition from line (2) to line (3), the student has differentiated the numerator and denominator separately, presumably to use l'Hospital's Rule. However, this is an incorrect application as the limit in line (2) does not have an indeterminate form. L'Hospital's Rule cannot be used there.
- (c) Substitution $x = 0$ in the second line gives the correct value of the limit: 4.

6 p**Z8.** Consider the integral below.

$$\int_{-2}^1 \sqrt{9 - (x - 1)^2} dx$$

- (a) Explain in your own words how you would calculate this integral without using Riemann sums or the fundamental theorem of calculus. **Hint:** Try graphing the integrand!
- (b) Find the exact value of the integral.

Solution

- (a) Observe that the graph of $y = \sqrt{9 - (x - 1)^2}$ is the top half of a circle with center $(1, 0)$ and radius 3. The leftmost point on the circle is $(-2, 0)$. Thus the integral is equal to the area of the left half of this semi-disc. That is, the region is congruent to a quarter-disc with radius 3.
- (b) The area of the region is $\frac{\pi r^2}{4}$ with $r = 3$, hence the area is $\frac{9\pi}{4}$.

6 p**Z9.** Consider the curve described by the following equation.

$$e^{12x+2y} = 6y - 3xy + 1$$

- (a) Find $\frac{dy}{dx}$ at a general point on this curve.
- (b) Calculate the slope of the line tangent to the curve at $(2, -12)$.
- (c) There is a point on the curve close to the origin with coordinates $(0.07, b)$, and the line tangent to the curve at the origin is $y = 3x$. Use linear approximation to estimate the value of b .

Solution

- (a) Differentiating each side of the equation with respect to x gives:

$$e^{12x+2y} \cdot \left(12 + 2\frac{dy}{dx}\right) = 6\frac{dy}{dx} - 3x\frac{dy}{dx} - 3y$$

Solving algebraically for y' gives:

$$\frac{dy}{dx} = \frac{12e^{12x+2y} + 3y}{6 - 3x - 2e^{12x+2y}}$$

- (b) Substituting $x = 2$ and $y = -12$ into the expression above gives $\frac{dy}{dx} = 12$.
- (c) The tangent line at the origin is a linear approximation of the curve near the origin. Hence the point $(0.07, b)$ lies approximately on this tangent line. Hence $b \approx 3(0.07) = 0.21$.

6 p **Z10.** Suppose the derivative of f is $f'(x) = 3x^2 - 6x - 9$ and that $f(1) = 10$.

- Find an equation of the line tangent to the graph of $y = f(x)$ at $x = 1$.
- Find the critical points of f .
- Where does f have a local minimum value? local maximum value?
- Calculate $f(0)$.
- Calculate the absolute maximum value of f on the interval $[0, 6]$. At what x -value does it occur?

Solution

- We have $f'(1) = 3 - 6 - 9 = -12$, whence an equation of the tangent line is $y = 10 - 12(x - 1)$.
- Solving $f'(x) = 0$, we find that the critical points of f are $x = -1$ and $x = 3$.
- A sign chart for $f'(x)$ reveals that $f'(x)$ is positive on the intervals $(-\infty, -1)$ and $(3, \infty)$; and $f'(x)$ is negative on the interval $(-1, 3)$. Since f' changes from positive to negative at $x = -1$, a local maximum occurs at $x = -1$. Since f' changes from negative to positive at $x = 3$, a local minimum occurs at $x = 3$.
- We find $f(x)$ by finding the most general antiderivative of $f'(x)$.

$$f(x) = \int f'(x) dx = x^3 - 3x^2 - 9x + C$$

The initial condition $f(1) = 10$ implies $1 - 3 - 9 + C = 10$, or $C = 21$. Hence

$$f(x) = x^3 - 3x^2 - 9x + 21$$

So $f(0) = 21$.

- The absolute maximum of f on $[0, 6]$ can occur only at an endpoint (0 or 6) or a critical number (-1 or 3). Calculating the values of f at these x -values gives: $f(0) = 21$, $f(-1) = 26$, $f(3) = -6$, and $f(6) = 75$. Hence the absolute maximum of f on $[0, 6]$ is 75, occurring at $x = 6$.

12 p **Z11.** A local park has hired you to construct a rectangular flower garden surrounded by a grass border that is 1 m wide on two sides and 2 m wide on the other two sides. (See the figure below.) The area of the garden only (the small rectangle) must be 126 m².

Your primary task is to find the dimensions of the garden that give the smallest possible combined area of the garden and the grass border. For this problem, let W be the horizontal width of the garden and let H be the vertical height of the garden.

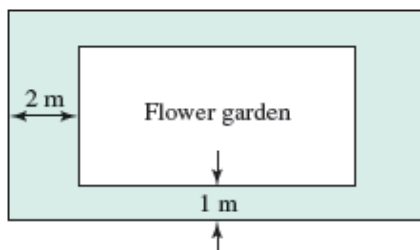

- What is the objective function for this problem in terms of W and H ?

- (b) What is the constraint equation for this problem in terms of W and H ?
 (c) Find the objective function in terms of W only.
 (d) What is the interval of interest for the objective function?
 (e) Find the values of W and H that minimize the total combined area.
 (f) What horizontal width W of the garden will *maximize* the total area?

Solution

- (a) The width of the combined area is $W + 4$ and the height of the combined area is $H + 2$. We seek to minimize the combined area, and so the objective function is

$$g(w, H) = (W + 4)(H + 2)$$

- (b) The garden must have an area of 126, and so the constraint equation is $WH = 126$.
 (c) Solving for H in the constraint gives $H = 126/W$, and substituting this into the objective gives:

$$f(W) = g\left(W, \frac{126}{W}\right) = (W + 4)\left(\frac{126}{W} + 2\right) = 134 + 2W + \frac{504}{W}$$

- (d) The width W can be any positive length (note that a length of 0 is not allowed since the garden area must be positive). So the interval of interest is $(0, \infty)$.
 (e) We solve $f'(W) = 0$ to find the critical numbers.

$$f'(W) = 2 - \frac{504}{W^2} = 0 \implies W = \sqrt{252} = 6\sqrt{7}$$

Observe that $f''(w) = \frac{1108}{W^3}$, which is positive for all $W > 0$. So by the second derivative test, $W = 6\sqrt{7}$ gives a local minimum. Since it gives the only local extreme value on $(0, \infty)$, f has a global minimum value on $(0, \infty)$ at $W = 6\sqrt{7}$. The corresponding height is $H = \frac{126}{6\sqrt{7}} = 3\sqrt{7}$.

- (f) None of our work above changes. However, we now note that $f(w) \rightarrow \infty$ as $W \rightarrow 0^+$ or as $W \rightarrow \infty$. Hence there is no maximum combined area. We may obtain an arbitrarily large combined area by simply taking the width W to be either arbitrarily small or arbitrarily large.

12 p

Z12. A farmer's tractor pulls a rope of length 12 m attached to a bale of hay through a pulley is 8 m above the ground. The vertical distance between the tractor and the pulley (the distance from P to Q) is 7 m. The tractor is moving to the left at rate of 2 m/sec, which causes the bale of hay to rise off the ground.

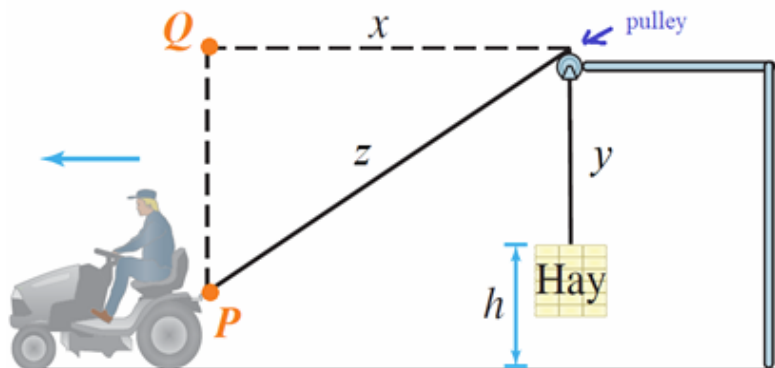

- (a) The rate of change (with respect to time) of which variable is equal to the speed of the tractor?
- (b) Use the Pythagorean theorem to find an equation that holds for all time and involves only the variables x and z .
- (c) Use the fact that the length of the rope is constant to find an equation that holds for all time and involves only the variables z and y .
- (d) Use the fact that the height of the pulley is constant to find an equation that holds for all time and involves only the variables h and y .
- (e) Combine the equations from parts (b), (c), and (d) to find an equation that holds for all time and involves only the variables x and h .
- (f) The rate of change (with respect to time) of which variable is equal to the rate at which the bale of hay is rising?
- (g) Find the rate at which the bale of hay is rising off the ground when the horizontal distance between the tractor and the bale of hay is 8 m.

Solution

- (a) x
- (b) $x^2 + 7^2 = z^2$, or $x^2 + 49 = z^2$
- (c) $y + z = 12$
- (d) $y + h = 8$
- (e) Subtracting the last two equations gives $z - h = 4$, or $z = h + 4$. Substituting this expression for z in the first equation gives $x^2 + 49 = (h + 4)^2$. We will write this equation as:

$$h = \sqrt{x^2 + 49} - 4$$

- (f) h
- (g) Differentiating the equation in part (e) gives:

$$\frac{dh}{dt} = \frac{x \frac{dx}{dt}}{\sqrt{x^2 + 49}}$$

We are given that $\frac{dx}{dt} = 2$ (speed of the tractor) and that $x = 8$ (tractor is 8 m horizontally away from pulley). Hence we have:

$$\frac{dh}{dt} = \frac{16}{\sqrt{113}} \approx 1.51$$

So the bale of hay is rising at approximately 1.51 m/sec.

12 p

Z13. Define the function g by $g(x) = \int_0^x f(t) dt$, where the graph of $y = f(x)$ is given below. The graph consists of four line segments and one semicircle. **Note:** f and g are different functions!

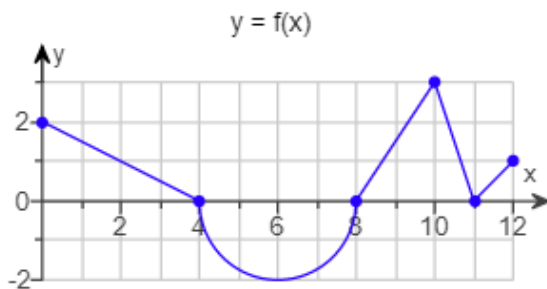

- Calculate $f'(9)$.
- Calculate $f'(6)$.
- Calculate $g'(6)$.
- Calculate $g(11) - g(8)$.
- Is the statement " $g(4) > g(0)$ " true or false?
- Find the critical numbers of g in the interval $(0, 12)$.

Solution

- Observe that $f'(9)$ is simply the slope of given graph at $x = 9$. Hence $f'(9) = \frac{3-0}{10-8} = 1.5$.
- Observe that $f'(6)$ is the derivative of the given graph at $x = 6$, and f has a horizontal tangent line at $x = 6$. Hence $f'(6) = 0$.
- By the fundamental theorem of calculus, $g'(x) = f(x)$. Hence $g'(6) = f(6) = -2$.
- By the additivity property of integrals, $g(11) - g(8) = \int_8^{11} f(t) dt$. This is the area of the region below the graph of $y = f(t)$ and above the interval $[8, 11]$ on the t -axis. Note that this region is a triangle with base 3 and height 3. Hence $g(11) - g(8) = \frac{1}{2} \cdot 3 \cdot 3 = 4.5$.
- Note that $g(0) = 0$ by properties of integrals, and $g(4) > 0$ since $g(4)$ is the area of a triangle that lies above the t -axis. Hence the given statement is true.
- The critical numbers of g are those x -values where either $g'(x) = 0$ or $g'(x)$ does not exist. Recall from part (c) that $g'(x) = f(x)$. Clearly $f(x)$ is defined everywhere on $(0, 12)$. So the only critical numbers of g are the solutions to $f'(x) = 0$: $x = 4$, $x = 8$, and $x = 11$.

12 p

Z14. For this problem, you will explore the substitution rule for two different integrals.

- Consider the first (definite) integral:

$$J_1 = \int_{e^{-3}}^{e^2} \frac{2 \ln(x) - 3}{5x} dx$$

Use the substitution $u = 2 \ln(x) - 3$ to compute this integral. After you do the the substitution and translate the integral from being in terms of x to being in terms of u , you have an integral of the following form:

$$J_1 = \int_a^b g(u) du$$

where $a < b$ and there is no number to the left of the integral sign.

- After the substitution, what is the integrand $g(u)$?
- After the substitution, what is the lower limit of integration? upper limit of integration?

(b) Now use the fundamental theorem of calculus to calculate J_1 , giving the following:

$$J_1 = \int_a^b g(u) du = G(b) - G(a)$$

- (i) What is the relationship between g and G ?
- (ii) Calculate J_1 .

(c) Now consider the second (indefinite) integral:

$$J_2 = \int \frac{\ln(x)}{3x^2} dx$$

Use the substitution $u = \ln(x)$. After you do the the substitution and translate the integral from being in terms of x to be being in terms of u , you have an integral of the following form:

$$J_2 = \int f(u) du$$

where there is no number to the left of the integral sign.

- (i) After the substitution, what is the integrand $f(u)$?

Solution

- (a) (i) We have $u = 2 \ln(x) - 3$, whence $\frac{du}{dx} = \frac{2}{x}$, or $dx = \frac{x}{2} du$. Hence we have:

$$\frac{2 \ln(x) - 3}{5x} dx = \frac{u}{5x} \cdot \left(\frac{x}{2} du\right) = \frac{u}{10} du$$

So the new integrand is $g(u) = u/10$.

- (ii) We find the new limits of integration by substituting the old limits of integration into our relation $u = 2 \ln(x) - 3$. Hence the new limits are:

$$\begin{aligned} x = e^{-3} &\implies u = 2 \cdot (-3) - 3 = -9 \\ x = e^2 &\implies u = 2 \cdot (2) - 3 = 1 \end{aligned}$$

So the new lower and upper limits of integration are -9 and 1 , respectively.

- (b) (i) g is the derivative of G (equivalently, G is an antiderivative of g).
(ii) Combining all of the previous parts, we have:

$$J_1 = \int_{-9}^1 \frac{u}{10} du = \frac{u^2}{20} \Big|_{-9}^1 = \frac{1}{20}(1 - 81) = -4$$

- (c) (i) We have $u = \ln(x)$, whence $\frac{du}{dx} = \frac{1}{x}$, or $dx = x du$. Hence we have:

$$J_2 = \int \frac{u}{3x^2} \cdot (x du) = \int \frac{u}{3x} du$$

We are still left with a factor of x , but the integrand must be only in terms of u . Since $u = \ln(x)$, we have $x = e^u$. Hence we have:

$$J_2 = \int \frac{u}{3e^u} du = \int \frac{u}{3e^u} du$$

So the new integrand is $f(u) = \frac{1}{3}ue^{-u}$.

4.2 Fall 2021

Z15. For each part, use the graph of $y = g(x)$.

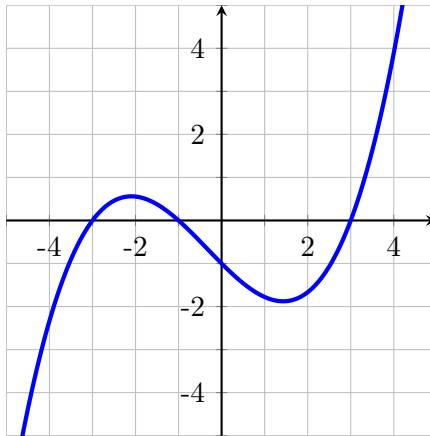

2 p

(a) How many solutions does the equation $g'(x) = 0$ have?

2 p

(b) Order the following quantities from least to greatest: $g'(-2.5)$, $g'(-2)$, $g'(0)$, and $g'(4)$. In your answer, write these quantities symbolically; do not give a numerical estimate.

2 p

(c) What is the sign of $g''(-3)$ (negative, positive, or zero)? If there is not enough information to determine the value, explain why.

2 p

(d) Let $h(x) = g(x)^2$. What is the sign of $h'(-4)$ (negative, positive, or zero)? If there is not enough information to determine the value, explain why.

Solution

- (a) The function g is differentiable for all x and has two local extrema (one local min and one local max). So $g'(x) = 0$ has two solutions.
- (b) We note the following: $g'(-2.5)$ is small and positive, $g'(-2) = 0$, $g'(0)$ is small and negative, and $g'(4)$ is large and positive. Thus the correct order is: $g'(0)$, $g'(-2)$, $g'(-2.5)$, $g'(4)$.
- (c) The function g is concave down in an interval containing $x = -3$. Thus $g''(-3)$ is positive.
- (d) We have $h'(x) = 2g(x)g'(x)$, whence $h'(-4) = 2g(-4)g'(-4)$. Observe that $g(-4) < 0$ and $g'(-4) > 0$. Thus $h'(-4) < 0$.

6 p

Z16. Let $f(x)$ be the following function, where k is an unspecified constant. Find the value of k that makes f continuous at $x = 2$ or determine that no such value of k exists.

$$f(x) = \begin{cases} 27x - kx^2 & x < 2 \\ -6 & x = 2 \\ 3x^3 + k & x > 2 \end{cases}$$

In your work, you must use limit-based methods to solve this problem. Solutions that have work that is not based on limits will not receive full credit.

Solution

We first compute the left-limit, right-limit, and function value at $x = 2$.

$$\lim_{x \rightarrow 2^-} f(x) = \lim_{x \rightarrow 2^-} (27x - kx^2) = 54 - 4k$$

$$\lim_{x \rightarrow 2^+} f(x) = \lim_{x \rightarrow 2^+} (3x^3 + k) = 24 + kf(2) = -6$$

If f is to be continuous at $x = 2$, these quantities must all be equal. Hence we must have $54 - 4k = -6$ and $24 + k = -6$. However, this is impossible since the first equation gives $k = 15$ and the second equation gives $k = -30$. There is no value of k that satisfies both equations simultaneously. Hence there is no value of k for which f is continuous at $x = 2$.

Z17. Consider the curve described by the following equation: $2x^2 - 2xy + 3y^2 = 60$.

4 p

(a) Find $\frac{dy}{dx}$ for a general point on the curve.

2 p

(b) Find the x -coordinate of each point on the curve where the tangent line is horizontal.

Solution

(a) We use implicit differentiation with respect to x .

$$4x - 2y - 2x \frac{dy}{dx} + 6y \frac{dy}{dx} = 0$$

Solving algebraically for $\frac{dy}{dx}$ then gives:

$$\frac{dy}{dx} = \frac{2y - 4x}{6y - 2x}$$

(b) The tangent line is horizontal at points where $\frac{dy}{dx} = 0$, or where $2y - 4x = 0$, or where $y = 2x$. Such points must also lie on the curve, whence such points must satisfy both the equation $y = 2x$ and the equation $2x^2 - 2xy + 3y^2 = 60$.

Substituting the former into the latter gives $2x^2 - 4x^2 + 12x^2 = 60$, or $10x^2 = 60$, or $x = \pm\sqrt{6}$. Hence the two points where the tangent line is horizontal are $(-\sqrt{6}, -2\sqrt{6})$ and $(\sqrt{6}, 2\sqrt{6})$.

Z18. The parts of this problem are not related.

4 p

(a) Calculate the integral $\int_2^4 \frac{18t - 3t^2}{t} dt$.

4 p

(b) Calculate the area of the region below the curve $y = 23 \sin(x) \cos^2(x)$ and above the interval $[0, \frac{\pi}{2}]$ on the x -axis. (Note that $y \geq 0$ on this interval.)

Solution

(a) Simplify the integrand using basic algebra, then use the fundamental theorem of calculus.

$$\int_2^4 \frac{18t - 3t^2}{t} dt = \int_2^4 (18 - 3t) dt = \left(18t - \frac{3}{2}t^2\right) \Big|_2^4 = (72 - 24) - (36 - 6) = 18$$

- (b) The area of the region is equal to the integral $\int_0^{\pi/2} 23 \sin(x) \cos^2(x) dx$. We use substitution rule with $u = \cos(x)$ (whence $-du = \sin(x) dx$).

$$\int_0^{\pi/2} 23 \sin(x) \cos^2(x) dx = \int_1^0 (-23u^2) du = \left(-\frac{23}{3}u^3 \right) \Big|_1^0 = 0 - \frac{-23}{3} = \frac{23}{3}$$

- 6 p** **Z19.** Farmer Green is building an enclosure that must have a total area of 48 m^2 . The pen will also be subdivided into 6 pens of equal area, as shown on the right. Find the dimensions of the enclosure that will require the least amount of fencing. As you work, fill in the answer boxes below. You must use calculus-based methods in your work. You must also justify that your answer really does give the least fencing.



constraint equation in terms of x and y :	
objective function in terms of x only:	
interval of interest:	
dimensions of desired enclosure (in meters):	$\frac{\text{total length } (x)}{\text{total width } (y)}$

Solution

We seek to minimize the total length of fencing, whence our objective function is $F(x, y) = 4x + 3y$. The total area must be 48, whence our constraint equation is $xy = 48$. Solving for y gives $y = \frac{48}{x}$, and substituting this expression into F gives our objective function in terms of x only:

$$f(x) = 4x + \frac{144}{x}$$

The length x can't be negative, but x also can't equal 0 since that would violation the constraint equation. Hence the interval of interest is $(0, \infty)$. We now find the critical points of f on this interval.

$$f'(x) = 4 - \frac{144}{x^2}$$

Solving $f'(x) = 0$ on the interval $(0, \infty)$ gives $x = 6$. Observe that $f''(x) = \frac{288}{x^3}$, whence $f''(6) > 0$. This means f has a local minimum at $x = 6$. Since $x = 6$ is the only critical point of f , $x = 6$ must also give an absolute minimum. Hence the dimensions of the pen should be $x = 6$ and $y = \frac{48}{6} = 8$.

- 12 p** **Z20.** For each part, calculate the limit or show that it does not exist. If the limit is “ $+\infty$ ” or “ $-\infty$ ”, write that as your answer, instead of “does not exist”.

- (a) $\lim_{x \rightarrow 1} \left(\frac{x^4 - x}{\ln(77x - 76)} \right)$
- (b) $\lim_{x \rightarrow -\infty} \left(\frac{\sqrt{36x^2 + 63}}{31x} \right)$
- (c) $\lim_{x \rightarrow 2^+} f(x)$, with $f(x) = \begin{cases} 1 + 4x & x \leq 2 \\ \frac{x^2 - 4}{x - 2} & x > 2 \end{cases}$
- (d) $\lim_{x \rightarrow 5^-} \left(\frac{\cos(\pi x)}{x^2 - 25} \right)$

Solution

(a) Direct substitution gives " $\frac{0}{0}$ ", and so we use L'Hospital's Rule.

$$\lim_{x \rightarrow 1} \left(\frac{x^4 - x}{\ln(77x - 76)} \right) \stackrel{H}{=} \lim_{x \rightarrow 1} \left(\frac{4x^3 - 1}{\frac{1}{77x - 76} \cdot 77} \right) = \frac{3}{77}$$

(b) We factor out x^2 from inside the square root in the numerator. Observe that since x goes to *negative* infinity, we have $\sqrt{x^2} = |x| = -x$.

$$\lim_{x \rightarrow -\infty} \left(\frac{\sqrt{36x^2 + 63}}{31x} \right) = \lim_{x \rightarrow -\infty} \left(\frac{-x\sqrt{36 + \frac{63}{x^2}}}{31x} \right) = \lim_{x \rightarrow -\infty} \left(\frac{-\sqrt{36 + \frac{63}{x^2}}}{31} \right) = \frac{-6}{31}$$

(c) We factor and cancel.

$$\lim_{x \rightarrow 2^+} f(x) = \lim_{x \rightarrow 2^+} \left(\frac{x^2 - 4}{x - 2} \right) = \lim_{x \rightarrow 2^+} \left(\frac{(x - 2)(x + 2)}{x - 2} \right) = \lim_{x \rightarrow 2^+} (x + 2) = 4$$

(d) Direct substitution gives " $\frac{-1}{0^-}$ ", whence the one-sided limit must be infinite. Observe that the numerator is negative (goes to -1) as $x \rightarrow 5^-$, and the denominator goes to 0 but remains negative as $x \rightarrow 5^-$. (For instance, use test points such as $x = 4.99$.) Hence the desired limit is $\frac{-1}{0^-} = +\infty$.

- 4 p** **Z21.** For any time $t > 0$, the acceleration of a particle is given by $a(t) = 1 + \frac{3}{\sqrt{t}}$, and the particle has velocity $v = -20$ when $t = 1$. Find the velocity of the particle when $t = 16$.

Solution

We first obtain the velocity by antidifferentiating the acceleration.

$$v(t) = \int a(t) dt = \int \left(1 + 3t^{-1/2} \right) dt = t + 6t^{1/2} + C$$

We are given that $v(1) = -20$, whence $-20 = 1 + 6 + C$, and so $C = -27$. Our velocity function is:

$$v(t) = t + 6t^{1/2} - 27$$

Thus $v(16) = 16 + 6 \cdot 4 - 27 = 13$.

- 8 p** **Z22.** Let $F(x) = \int_0^x f(t) dt$, where the graph of $y = f(t)$ is given below. For each part, use this information to calculate the indicated item.

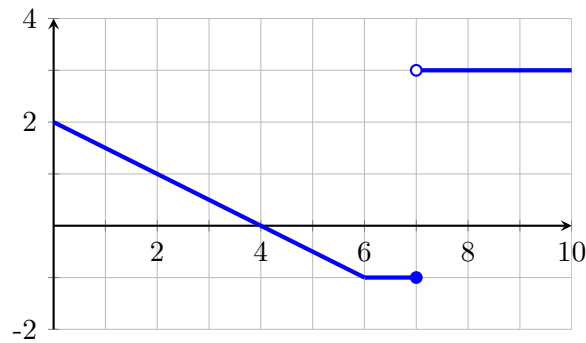

(a) $F(10)$

(b) $F'(6)$

(c) $\int_0^6 |f(t)| dt$

(d) $\int_0^4 (f'(t) + 5) dt$

Solution

(a) The value of $F(10)$ is equal to the (net) area bounded by the graph of $y = f(x)$, the t -axis, and the vertical lines $t = 0$ and $t = 10$.

- The region from $t = 0$ to $t = 4$ consists of a triangle with base 4 and height 2, hence area $\frac{1}{2}(4)(2) = 4$.
- The region from $t = 4$ to $t = 7$ consists of a trapezoid with parallel bases 1 and 3 and height 1, hence area $\frac{1}{2}(3 + 1)(1) = 2$.
- The region from $t = 7$ to $t = 10$ consists of a square of length 3, hence area 9.

The total net area is $F(10) = 4 - 2 + 9 = 11$.

(b) By the fundamental theorem of calculus, $F'(6) = f(6) = -1$.

(c) Observe that the graph of $y = |f(t)|$ is identical to the graph of $y = f(t)$, except any portion of the graph below the t -axis is reflected across (above) the t -axis. This effectively means that we can compute the desired integral using the graph of $y = f(t)$, but counting any area below the t -axis as positive instead of as negative.

The region from $t = 0$ to $t = 4$ has area 4 and the region from $t = 4$ to $t = 6$ has area 1.

Hence the desired integral is $\int_0^6 |f(t)| dt = 4 + 1 = 5$.

(d) By the fundamental theorem of calculus, we have:

$$\int_0^4 (f'(t) + 5) dt = (f(t) + 5t)|_0^4 = (f(4) + 20) - (f(0) + 0) = 0 + 20 - 2 = 18$$

4 p **Z23.** Use linear approximation to estimate $\tan\left(\frac{\pi}{4} + 0.12\right) - \tan\left(\frac{\pi}{4}\right)$.

Solution

We use the tangent line to $f(x) = \tan(x)$ at $x = \frac{\pi}{4}$ to estimate the given value. Observe that $f\left(\frac{\pi}{4}\right) = 1$ and $f'\left(\frac{\pi}{4}\right) = \sec^2\left(\frac{\pi}{4}\right) = 2$. Hence the tangent line is:

$$y = 1 + 2\left(x - \frac{\pi}{4}\right)$$

Linear approximation tells us that if x is near $\frac{\pi}{4}$ then the tangent line values can be used (approximately) in place of the function values. Hence we have $\tan\left(\frac{\pi}{4} + 0.12\right) \approx 1 + 2(0.12) = 1.24$.

Our estimate for the given difference is thus $1.24 - 1 = 0.24$.

Z24. Let $f(x) = x^3(3x - 4)$.

4 p

(a) Find where relative extrema of f occur (if any). Classify each as a local minimum or a local maximum.

2 p

(b) Find the absolute extrema of f on $[-1, 2]$ and the x -values at which they occur.

Solution

- (a) We have $f(x) = 3x^4 - 4x^3$, whence $f'(x) = 12x^3 - 12x^2 = 12x^2(x - 1)$. The critical points of f are $x = 0$ and $x = 1$. The derivative $f'(x)$ does not change sign at $x = 0$, whence there is no local extremum at $x = 0$. However, $f'(x)$ changes sign from negative to positive at $x = 1$, whence there is a local minimum at $x = 1$. (Alternatively, note that $f''(x) = 36x^2 - 24x$ and $f''(1) = 12 > 0$.)
- (b) We need only compare the endpoint values and critical values: $f(-1) = 7$, $f(0) = 0$, $f(1) = -1$, and $f(2) = 16$. Hence the absolute minimum is -1 at $x = 1$, and the absolute maximum is 16 at $x = 2$.

6 p

Z25. For each part, find all vertical asymptotes of the given function.

(a) $f(x) = \frac{x^2 - 8x + 15}{x^2 - 9}$

(b) $g(x) = \frac{e^{x+3} - 1}{x^2 - 9}$

Solution

(a) First factor and cancel.

$$f(x) = \frac{x^2 - 8x + 15}{x^2 - 9} = \frac{(x - 3)(x - 5)}{(x - 3)(x + 3)} = \frac{x - 5}{x + 3}$$

Hence $f(x)$ has a vertical asymptote at $x = -3$ only.

(b) We note that the denominator of $g(x)$ equals 0 only when $x = -3$ or $x = 3$. Direct substitution of $x = 3$ gives the expression " $\frac{e^6 - 1}{0}$ " (nonzero number divided by 0), and so $x = 3$ is a vertical asymptote of $g(x)$. However, we have the following for $x = -3$ after using L'Hospital's Rule:

$$\lim_{x \rightarrow -3} g(x) = \lim_{x \rightarrow -3} \left(\frac{e^{x+3} - 1}{x^2 - 9} \right) \stackrel{H}{=} \lim_{x \rightarrow -3} \left(\frac{e^{x+3}}{2x} \right) = -\frac{1}{6}$$

Since this limit is not infinite, there is no vertical asymptote at $x = -3$.

Z26. A hot-air balloon is floating directly above the point Q on the ground and is descending at a constant rate of 10 ft/sec. A camera is on the ground at point P , which is 500 feet from point Q . See the figure below.

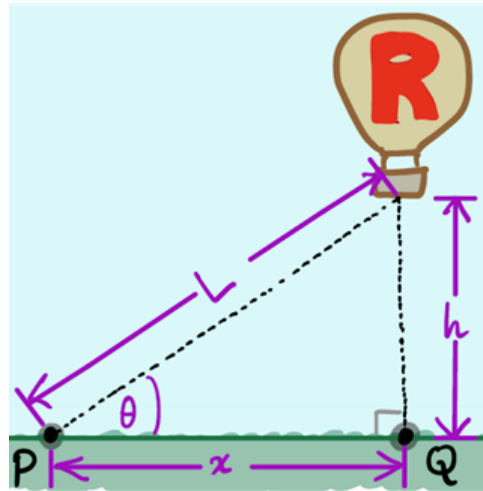

2 p

(a) What is the sign of $\frac{dh}{dt}$ (negative, positive, or zero)? If there is not enough information to determine the value, explain why.

2 p

(b) How is $\cos(\theta)$ changing over time? Circle your answer below.

(i) increasing over time

(iv) sometimes increasing and

(ii) decreasing over time

sometimes decreasing

(iii) constant over time

(v) not enough information to determine

4 p

(c) What is the rate of change of the distance between the camera and the balloon when the balloon is 600 feet above the ground? *You must give correct units as part of your answer.*

Solution

(a) The balloon is descending, whence h is decreasing. So $\frac{dh}{dt}$ is negative.

(b) Note that $\cos(\theta) = \frac{x}{L}$ and x is a fixed number. As the balloon descends, L decreases, whence the fraction $\frac{x}{L}$ must increase. So $\cos(\theta)$ is increasing.

(c) We have $500^2 + h^2 = L^2$ for all t . Differentiating with respect to t (and canceling a factor of 2) gives $h\frac{dh}{dt} = L\frac{dL}{dt}$. At the specified time, we have $h = 600$ and $\frac{dh}{dt} = -10$. So our two equations at the specified time give:

$$500^2 + 600^2 = L^2 \qquad -6000 = L\frac{dL}{dt}$$

The first equation gives $L = 100\sqrt{41}$, and substituting this value into the second equation gives

$$\frac{dL}{dt} = \frac{-60}{\sqrt{41}}$$

The units are "ft/sec".

6 p

Z27. Consider the function $g(x)$, whose first two derivatives are given below. **Note:** Do not attempt to calculate $g(x)$. Also assume that $g(x)$ has the same domain as $g'(x)$.

$$g'(x) = \frac{8x^{17}}{x-32} \qquad g''(x) = \frac{128x^{16}(x-34)}{(x-32)^2}$$

Fill in the table below with information about the graph of $y = f(x)$. For each part, write "NONE" as your answer if appropriate. Where applicable, give a comma-separated list of intervals that are as inclusive as possible.

You do not have to show work, and each table item will be graded with no partial credit.

Solution	
g is increasing on:	$(-\infty, 0], (32, \infty)$
g is decreasing on:	$[0, 32)$
g is concave up on:	$[34, \infty)$
g is concave down on:	$(-\infty, 32), (32, 34]$
x -coordinate(s) of relative maxima	$x = 0$
x -coordinate(s) of relative minima	NONE
x -coordinate(s) of inflection point(s)	$x = 34$

Z28. The parts of this problem are not related.

3 p

(a) Suppose that when x units are produced, the total cost is $C(x) = 2x^2 + 10x + 18$ and the selling price per unit is $p(x) = 46 - x$. Find the level of production that maximizes total profit.

3 p

(b) Suppose the total cost of producing q units is $C(q) = q^3 + 20q^2 + 200q + 2000$. Use marginal analysis to estimate the cost of the 3rd unit.

Solution

(a) The total revenue is $R(x) = xp(x) = 46x - x^2$, and so the total profit is $P(x) = R(x) - C(x) = -3x^2 + 36x - 18$. Profit is maximized when $P'(x) = 0$.

$$0 = P'(x) = -6x + 36 \implies x = 6$$

(b) By marginal analysis, the cost of the 3rd unit is approximately:

$$C'(2) = (3q^2 + 40q + 200)|_{q=2} = 12 + 80 + 200 = 292$$