

Variety of Ways to Build and Cover a Slipcase

Materials:

PVA glue

Bone folder

Wax paper

Davey board/ book boards

Decorative paper (optional)

Bookcloth

Weights

Self-healing board

Book that you want to make a slipcase for

Directions:

(Optional – line the book board with decorative paper so that there is an image or matching pattern to the book that is going inside the slipcase. As book artists we look at every part of the book so when you look inside the slipcase it's better to see decorative paper rather than raw book board. If you'd prefer a color you can always use museum board that comes in a variety of colors. Otherwise use uncovered book board. When you glue down the decorative paper to the board, make sure the grain of your paper and the board are going in the same direction.)

Layout for parts of the Slipcase:

Give your box about a $\frac{1}{16}$ " to $\frac{1}{32}$ " on three sides so that the book will be snug in your slipcase. For those who have made a clamshell box before, the cutting, building and gluing is the same for the 3 – sided box. Add a board thickness to the sides of the 3-sided box.

Any place where you see arrows is the direction of the grain.

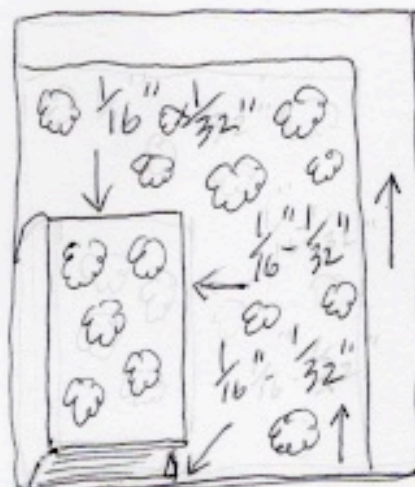
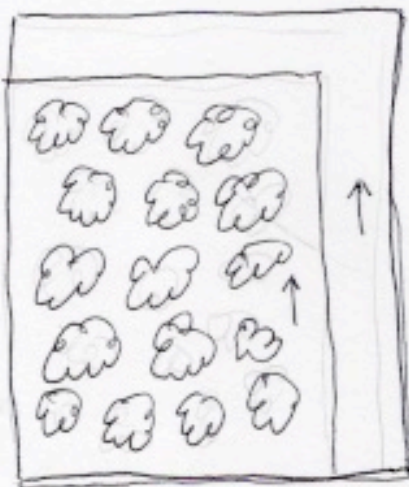

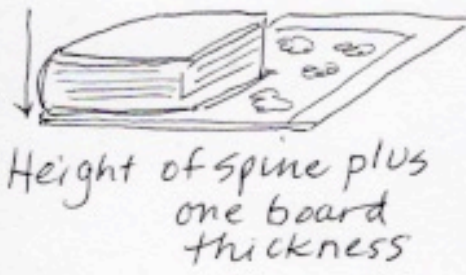

Height of spine plus one board thickness

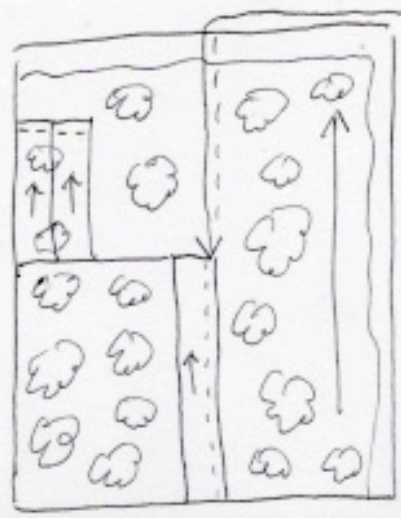

make first cut of board so that you have enough for the lid of the box.

When measuring the height of your book you must add a board thickness. When cutting out the boards you need to add a board thickness to the two sides of the box.

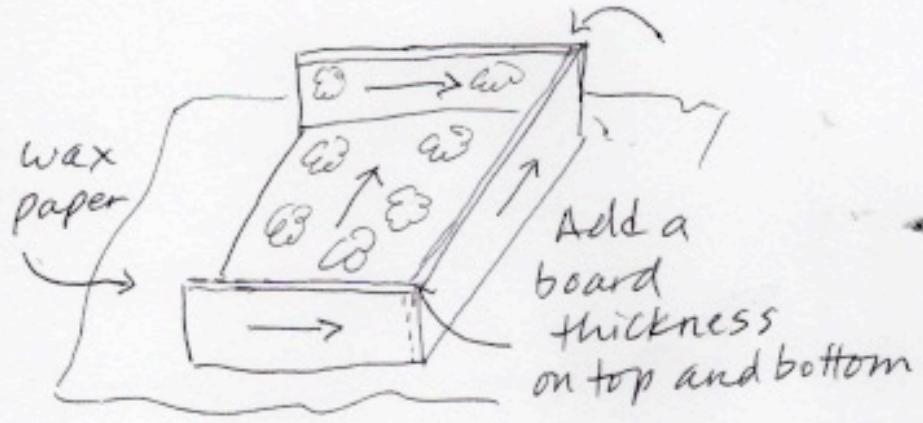

Use weights to glue the sides together and make sure you put wax paper underneath the box or you'll glue it to your self-healing board. Wait about 15 minutes - PVA glue dries quickly.

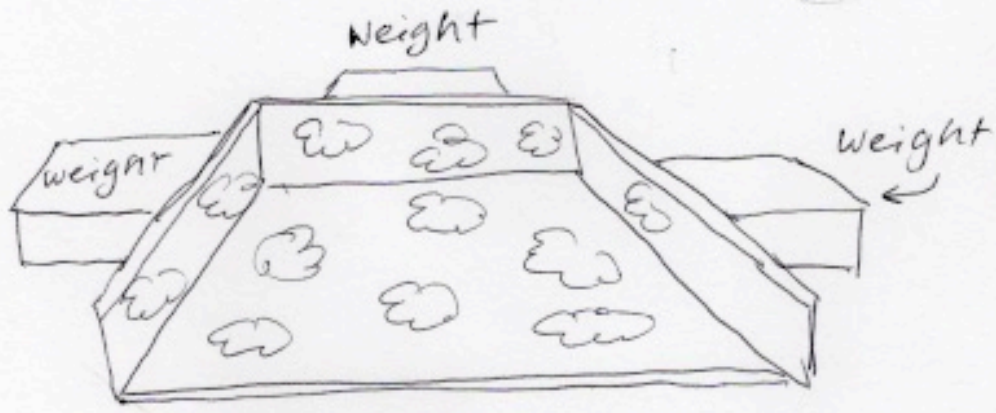

Once the 3 -sided box is dry, you need to put a lid on it. Flip the box upside down and trace the outline of the box. Make sure the grain is going in the right direction. Run glue either on the edges of the box or the three sides of the lid and place the lid on using weight to glue.

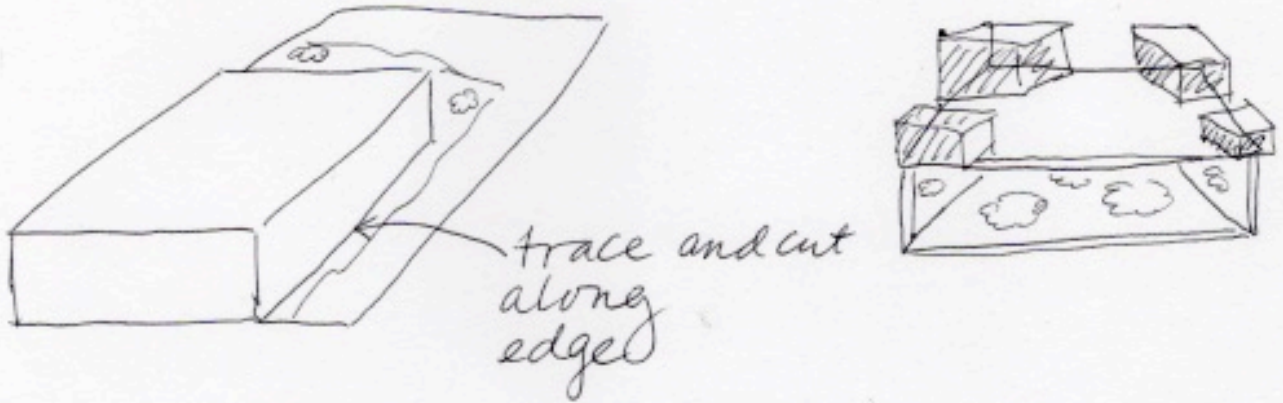

Covering the Slipcase:

There are several ways you can cover the slipcase. Because there are no hinges you can use paper to line the box. I prefer to use bookcloth because it's more durable.

Layout One:

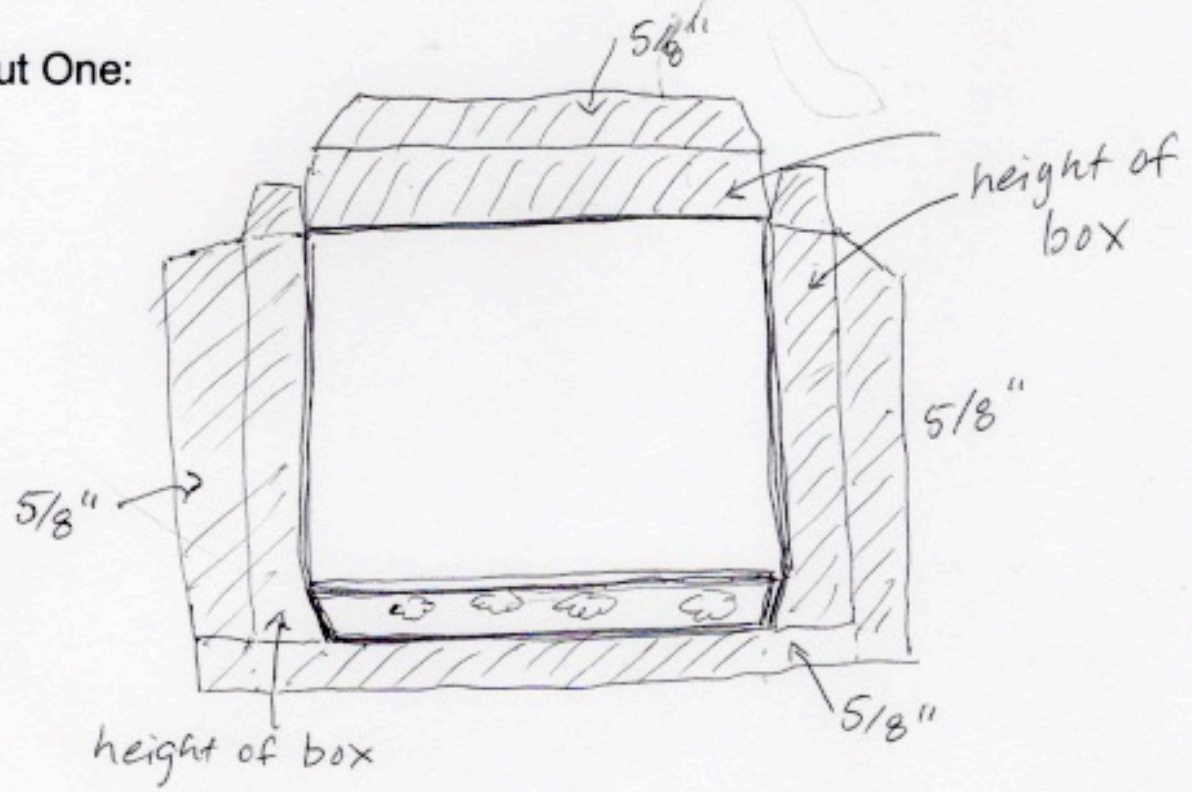

Cut a decorative sheet for the front or use bookcloth.

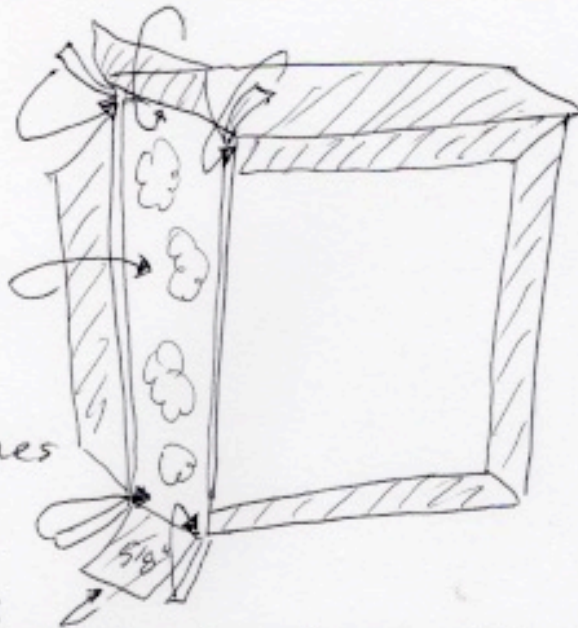

Cut a board thickness in corners and turn in



Cut decorative paper $\frac{1}{8}$ " smaller with $\frac{5}{8}$ " more on side turn in.

Layout Two:

Cut a strip that is the circumference of the box plus $\frac{5}{8}$ " on both sides. You can now use decorative papers or bookcloth on either side.

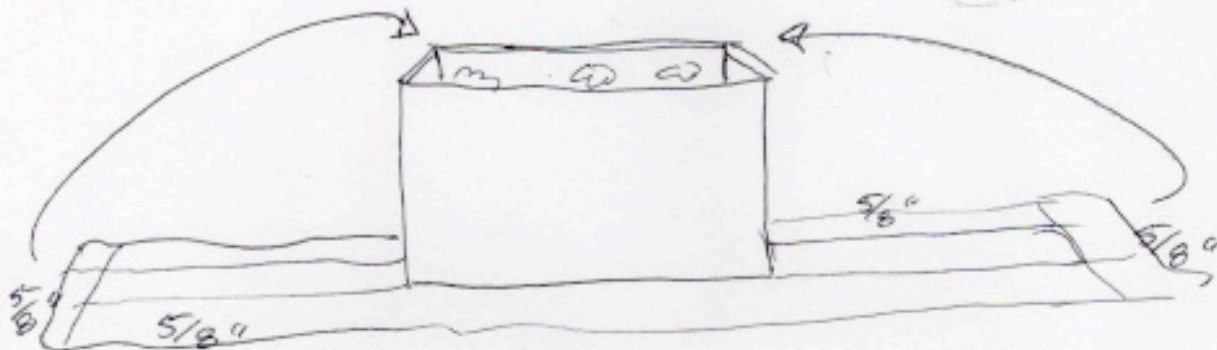

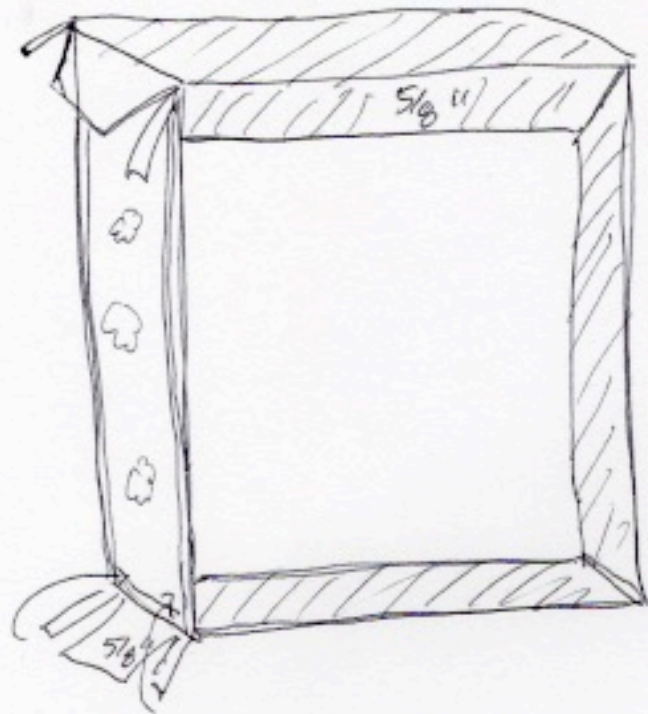

Cover front and back with decorative paper $\frac{1}{8}$ " smaller, plus $\frac{5}{8}$ " on one side to turn in.

